



DURLON[®]
SEALING SOLUTIONS

Gasket Manual

- ✓ PTFE
- ✓ Metallics & Semi-Metallics
- ✓ Compressed Non-Asbestos
- ✓ Custom Capabilities

2025



Welcome

Thank you for choosing the Durlon® Gasket Manual, your comprehensive guide to gasket selection, installation, and performance. Whether you're an engineer, maintenance professional, or industry specialist, this manual is designed to provide valuable insights into gasket materials, technical data, installation best practices, torque values, chemical resistance charts, and more. It serves as a go-to resource for optimizing sealing solutions in a wide range of applications.

Inside, you'll find in-depth knowledge of gasket fundamentals, material properties, and custom capabilities, ensuring you have the right tools to make informed decisions for your sealing needs. Our goal is to equip you with the expertise to enhance system reliability, safety, and efficiency. We hope this manual becomes an indispensable part of your operations, and we appreciate the opportunity to support your success with Durlon® Sealing Solutions.

At Durlon®, we are committed to continuous innovation and quality, ensuring our gasket solutions meet the highest industry standards. This manual not only provides essential guidelines but also offers troubleshooting tips and real-world application examples to help you overcome common sealing challenges. Whether dealing with extreme temperatures, aggressive chemicals, or high-pressure environments, our comprehensive resources will guide you in selecting the most suitable gasket for your specific needs. By leveraging the expertise within these pages, you can maximize the longevity and performance of your sealing solutions, ultimately improving operational efficiency and reducing downtime.

Content

6

Compressed Non-Asbestos Gasket Material

- 9 Durlon® 5000
- 10 Durlon® 7900/7925/7950
- 11 Durlon® 7910
- 12 Durlon® 8300
- 13 Durlon® 8400
- 14 Durlon® 8500
- 15 Durlon® 8600
- 16 Durlon® 8700
- 17 Durlon® 8900

18

PTFE Gasket Material

- 20 Durlon® 9000
- 21 Durlon® 9000N
- 22 Durlon® 9002
- 23 Durlon® 9200
- 24 Durlon® 9400
- 25 Durlon® 9600
- 26 Durlon® 9645 - NEW PRODUCT
- 27 Durlon® Virgin PTFE
- 28 Durlon® Joint Sealant

29

Rail Tank Car Manway Gaskets

- 29 Durlon® SecureSnap™

30

Low Seating Stress Gaskets

- 30 Durlon® RCA®
- 30 Durlon® 9000 Step Ring Gasket

31

Metallic & Semi-Metallic Gaskets

- 33 Durlon® Durtec®
- 34 Durlon® Flexible Graphite
- 36 Durlon® HT1000®
- 37 Durlon® HT1000® Paste
- 38 Durlon® CFG
- 39 Durlon® ETG
- 40 Durlon® SWG
- 42 Durlon® Kammprofile
- 44 Durlon® RTJ

45

iGuard™ Isolation & Sealing Kits

- 45 Durlon® iGuard™

49

Technical Information

- 49 Gasket Fundamentals
- 53 Gasket Installation
- 58 Gasket Factors
- 60 Torque Values
- 64 Chemical Resistance
- 72 Gasket Dimensions
- 77 Custom Capabilities
- 82 3D Interactive Videos
- 83 igasket+ App

Warning: Durlon® gasket materials should never be recommended when both temperature and pressure are at the maximum listed. Properties and applications stated are typical. No applications should be undertaken by anyone without independent study and evaluation for suitability. Never use more than one gasket in one flange joint and never reuse a gasket. Improper use or gasket selection could cause property damage and/or serious injury. Data reported is a compilation of field testing, field service reports and/or in-house testing. While the utmost care has gone into publishing the information contained herein, we assume no responsibility for errors. Specifications and information contained in this manual are subject to change without notice. This edition cancels and obsoletes all previous editions.

Our Sealing Products

Durlon® Sealing Products have the widest possible range of service applications in comparison to major competitors, therefore, the number of different types of gaskets required to be inventoried can be greatly reduced. This impacts process safety, because limiting the number of gasket styles reduces the chance of installing the wrong gasket in the wrong service. For these reasons, more and more original equipment manufacturers and industrial consumers are specifying Durlon® gasket materials for their needs.

Durlon® compressed non-asbestos gasket materials are high-density products featuring the most homogeneous combination of minerals, synthetic fibers, and elastomers. They are used in a wide variety of industries on a broad range of chemical applications at varying temperatures and pressures. Their excellent flexibility prevents large, narrow flange gaskets from breaking during cutting and installation, and their superior recovery ensures tight sealing during thermal cycling.

Durlon® filled PTFE and flexible graphite gasket materials compliment our compressed sheet family, by giving you the right gasket for all of your gasket needs.

Durlon® PTFE gaskets are exclusively manufactured at our factory located in Belleville, Ontario, Canada. Our compression molded and skived manufacturing process allows for the best control of physical properties and performance characteristics as compared with other manufacturing processes. With unique formulas of fillers, Durlon® PTFE products can meet your tough chemical applications and engineering specifications.

Durlon® metallic gaskets are manufactured from a combination of metals and designed to withstand extreme temperatures, pressures

and chemical exposure. Available in standard and custom configurations, these rugged metal gaskets are made of a wide range of materials to accommodate all types of process applications.

Durlon® semi-metallic gaskets include both metallic and non-metallic components, either containing a metal core with sealing materials on both flat surfaces, or a pliable core encased in a thin metallic casing. They are most popular due to this configuration, and are available in a wide variety of styles and sizes. They can typically be fabricated of any metal which is available in thin strip or sheet, and which can be welded. Therefore, they can be used against virtually any corrosive medium dependent upon the choice of the metal and filler/facing material.

Our computer-aided manufacturing process uses rigorous quality control programs to ensure premium quality product performance. The metallic component gives the gasket superior structural integrity, while the non-metallic element ensures the superior sealing.

OUR MISSION

To provide global industries with high quality sealing solutions that are innovative, cost effective, and reduce fugitive emissions. We strive to grow our business with a keen eye towards customer service and delivering value to our employees, and customers through training and development opportunities, and world class technical support. "If it needs to stay between the pipes, it needs to be Durlon®"

We will accomplish this by:

- Our commitment to understanding and meeting or exceeding our customer's expectations and requirements

- Continual improvements of our products, services and processes
- Remembering that we are here because of our customers

ADDITIONAL FEATURES

- Reliability backed by many years of experience
- Local distribution for quick and easy delivery
- Branding for easy identification and assurance of genuine Durlon® gasket material helps prevent misapplication
- A release agent on both sides of the CNA sheet ensures good anti-stick properties

Durlon® products are used in virtually every industrialized corner of the world. Our gasket materials are manufactured to ISO 9001 quality standards and are subjected to continuous testing and rigid quality control, ensuring unvarying performance on the job.

Our state-of-the-art research and development facility is geared to meet the ever changing demands required in today's variety of service conditions. Since their inception, Durlon® gasket materials have undergone many enhancements, each incorporating the latest technology to better meet the wide variety of industry's changing needs.

We recognize that today more emphasis is being placed on fugitive emissions via the Clean Air Act in Canada and the United States, as well as various regulations in other countries. One of our prime design objectives is to maximize the sealability of our gasket materials to meet and exceed fugitive emission requirements.

DURLON®
SEALING SOLUTIONS

Our Group of Companies

The Durlon® brand represents global leadership in sealing solutions with proven reliability, innovative processes and sustainable integrity in a wide range of demanding applications – oil & gas, chemical processing and power generation, to name just a few. We assure high-quality, environmentally-friendly materials from CNA & PTFE gasket sheets to flexible, metallic and high temperature gaskets.



Durabla Canada Ltd.
293 University Avenue
Belleville, ON K8N 5S3 Canada
844 636 1100
sales@durabla.ca
www.durabla.ca



Triangle Fluid Controls Ltd.
399 College St. E
Belleville, ON K8N 5S7 Canada
866 537 1133
info@trianglefluid.com
www.trianglefluid.com



Gasket Resources Inc.
280 Boot Road
Downingtown, PA 19335 USA
866 707 7300
sales@gasketresources.com
www.gasketresources.com



Gasket Resources Inc.
1814 Highway 146 South Suite 500
La Porte, TX 77571
866 707 7300
sales@gasketresources.com
www.gasketresources.com



Durabla Asia Pte Ltd.
2 Venture Drive
#12-18 Vision Exchange
Singapore 608526
(65) 9722 1438
gasketinfo@durablaasia.com.sg
www.durablaasia.com.sg



Durabla Fluid Controls (Nantong) Co., Ltd.
88 Linjiang Avenue, Linjiang Town
Haimen District, Nantong City 226132
Jiangsu Province, P.R.China
(86) 513 82222386/13816120534
infochina@durlon.com
www.durlon.cn

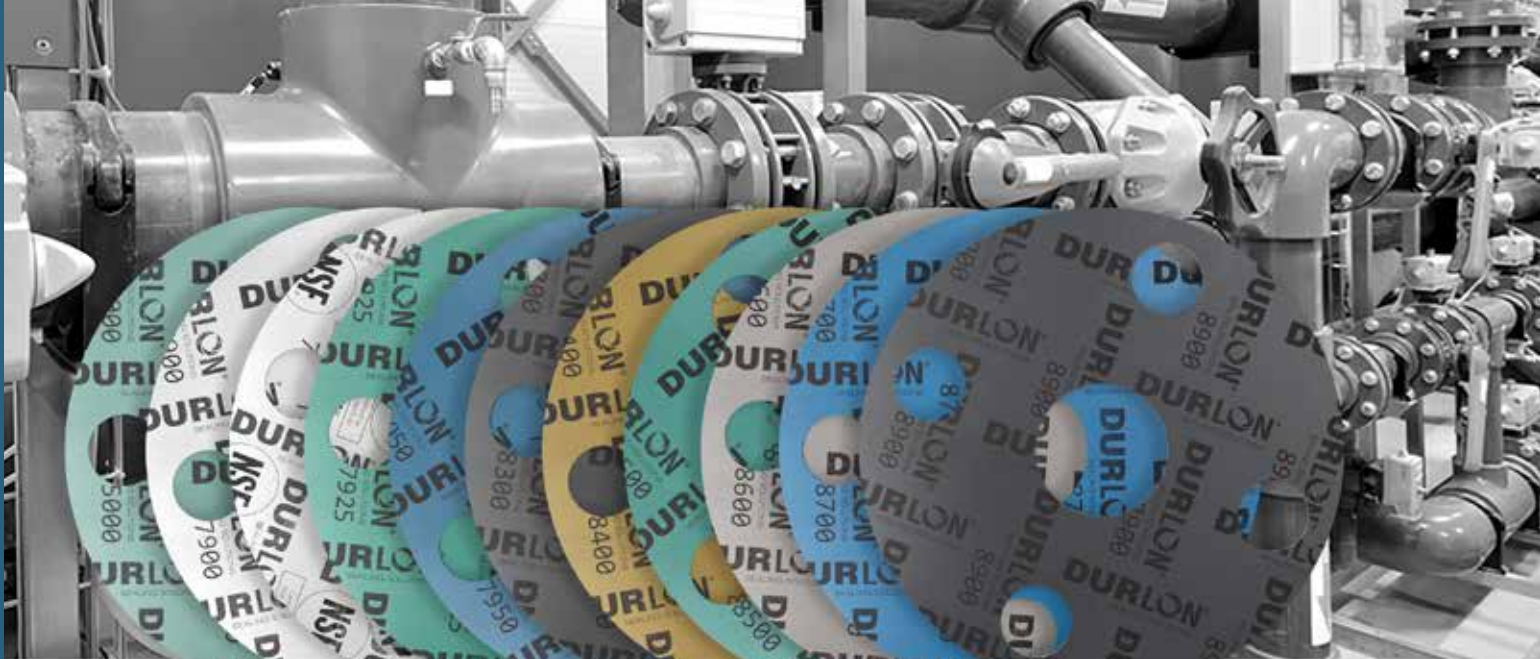

Compressed Non-Asbestos (CNA)

What is Compressed Non-Asbestos (CNA) gasket material?

Compressed Non-Asbestos is a sealing material consisting of a blend of organic and inorganic chemically resistant fibers and fillers together with an elastomer binder. The type of binder used is a key factor to consider when choosing a Compressed Non-Asbestos sheet for gasketing applications.

Manufacturers of compressed non-asbestos sheet produce a variety of materials that differ in the type of fibers and binders used which are purpose-suited for specific applications. Some sheets are designed for general service applications, while others are designed for use in applications involving chemicals, oils, extreme temperatures, etc.

How does Compressed Non-Asbestos differ from elastomers?

An elastomer is a polymer which possesses an elastic property. Elastomers are generally thermo-set materials which require curing through heat and pressure with the addition of sulfur or other curing agents. Natural and synthetic rubbers, such as styrene-butadiene rubber (SBR) and Buna-N (NBR), are elastomers.

Compressed Non-Asbestos, in contrast, is a material that combines organic and inorganic chemically resistant fibers and fillers. This type of binder employed gives the sheet the properties of elasticity and flexibility, while the fibers used give the sheet specific sealing characteristics and properties.

Why use Compressed Non-Asbestos sheets?

Compressed Non-Asbestos sheets have been developed to service a wide variety of sealing applications. These materials are an excellent choice for both general and severe service sealing applications.

Because Compressed Non-Asbestos sheets employ various combinations of fibers and binders, sheet manufacturers are able to produce a range of sheets with different mechanical specifications. Gaskets made from Compressed Non-Asbestos sheets have excellent sealing characteristics, torque retention, heat, and chemical resistance. These types of gaskets are an excellent choice for applications involving water, air, steam, oils, acids, and general chemicals. Our high performance industrial non-metallic gasket material sheets - Compressed Non-Asbestos contain high-pressure and high-temperature aramid fiber materials that are perfect for sealing, thermal, and mechanical applications (petrochemical, chemical, steam, pulp & paper, pharmaceutical and potable water industries).

Durlon® Compressed Non-Asbestos products range from economical to premium grades with organic and inorganic chemically resistant fibers and fillers to meet the majority of general service industrial piping applications and are the only products in its class to be manufactured by Durabla® Canada Ltd., and have been since the early 1980s. Explore our CNA product styles for the one that meets your application requirements.



Durabla® Canada Ltd. is a world leading manufacturer of Compressed Non-Asbestos Gasket Sheeting (CNA) for sealing, thermal, and mechanical applications. These high-pressure and high-temperature fiber gasket sheet materials are supplied to petrochemical, chemical, steam, pulp & paper, pharmaceutical and potable water industries.

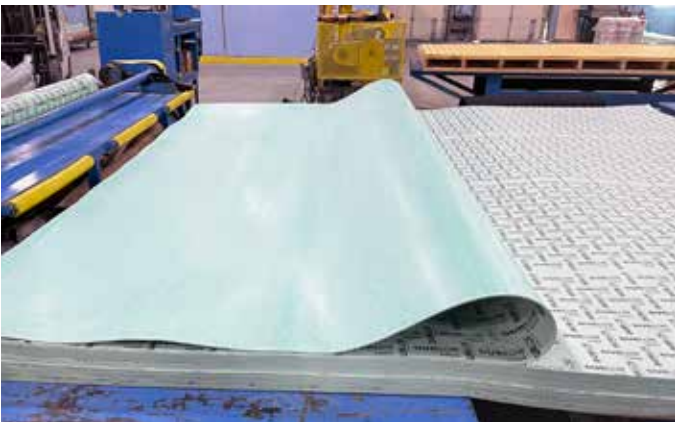

Durabla® Canada Ltd. adheres to rigid testing and quality control practices; all industrial products conform to ISO 9001:2015 Standards. The on-site research and development facilities is where technicians and the chief chemist produces and

tests custom sealing products to ensure high performance gasket material sheets for various industry applications.



Quality Assurance is a critical component of Durabla® Canada Ltd. The state-of-the-art facility, on-site research and development lab and products meet or exceed customer expectations. All Durabla® Canada Ltd. manufactured products undergo rigorous testing methods (ASTM) including leakage detection, and equipment is calibrated and traceable to NIST (National Institute of Standards and Technology). Products manufactured have full traceability from the raw materials all the way through each stage of the manufacturing process until it leaves the facility.

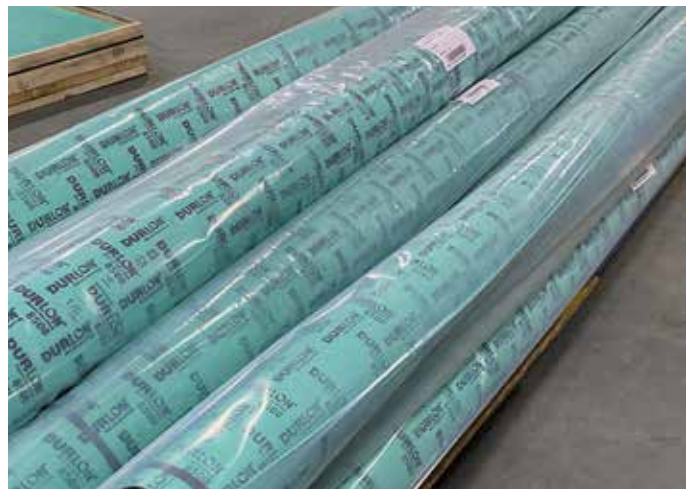

ENHANCED ANTI-STICK FORMULATION

Many gasket users have encountered problems with various compositions associated with flange adhesion for years.

Apart from the separation of flanges, surface imperfections can result from careless gasket removal. At elevated temperatures and pressures, there is a tendency for gasket materials to become embedded in the flange on opening. Sometimes disintegrated pieces stick to both flange mating surfaces, resulting in difficulty when removing the adhering gasket material in a safe, timely manner and without damaging the flanges.

To overcome this problem, anti-stick technology is incorporated into the manufacturing process of the Compressed Non-Asbestos Durlon® products. This technology allows for improved separation from flange surfaces during removal, saving time and energy.

This new technology allows Durlon® CNA to be the best in the industry; gasket and sheet materials have passed the MIL-G-24696 Navy Adhesion Test: 48 hrs at 366°F (186°C).



Many times, wire brushing or wire wheels are common practices, but if not done properly can lead to damaged process equipment or system contamination.

MILITARY ADHESION MIL-G-24696

Adhesion Comparison between gaskets produced with Anti-Stick and without Anti-Stick.

Sample size: 1.25" X 2.0" X 1/16"

Installation: Between two platens - Carbon Steel and Stainless Steel
Torque: 30 ft-lb.

Test Conditions: 48 hours at 366°F (186°C)

Mil-G-24696 Rating (A lower value is favorable):

- 1 - Gasket can be removed cleanly with virtually no remaining residual material.
- 2 - Only a small amount of face material remains when gasket is removed.
- 3 - Can be removed in one piece but some face material remains on platen.
- 4 - Can be removed in one piece but a considerable amount of face material remains.
- 5 - Cannot be removed in one piece and delaminates upon removal.

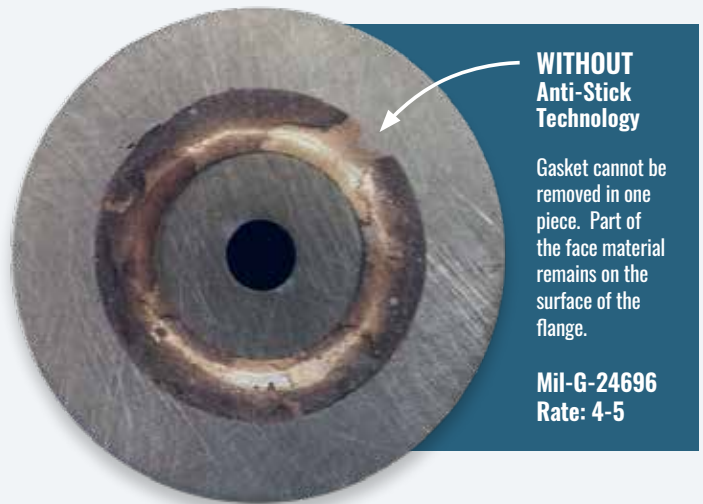
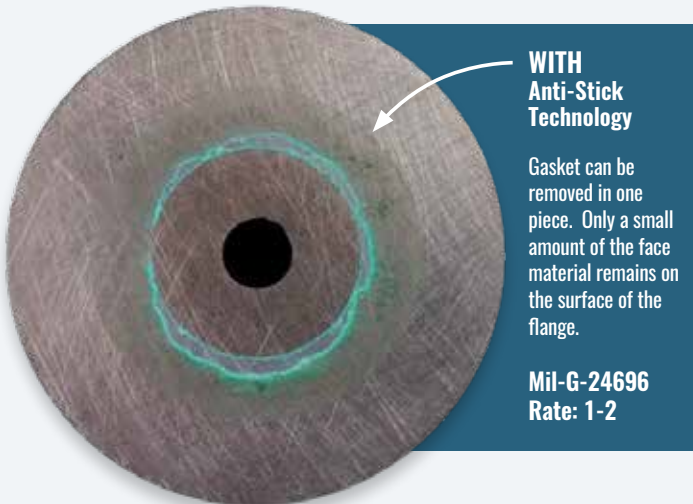

DURLON®

5000

Mineral Fiber with NBR Rubber Binder
Compressed Non-Asbestos Gasket Material
ASTM F104: F712120-A9B4E12K5L051M5

A good quality commercial grade compressed non-asbestos sheet with good chemical resistance for moderate service conditions suitable for oil, water, mild alkalis, mild acids, hydrocarbons and solvents.

INDUSTRY APPLICATIONS:

- Chemical Processing
- Food & Beverage
- General Industry
- Marine
- Mining
- OEM Services
- Oil & Gas
- Water & Wastewater

Gasket Factors	1/16"	1/8"
m	1.5	2.5
Y psi (MPa)	1,855 (12.8)	2,619 (18.1)
G _b psi (MPa)	474 (3.3)	902 (6.2)
a	0.256	0.253
G _s psi (MPa)	48 (0.3)	4 (0.03)

Certifications

RoHS Reach Declaration	Compliant
------------------------	-----------

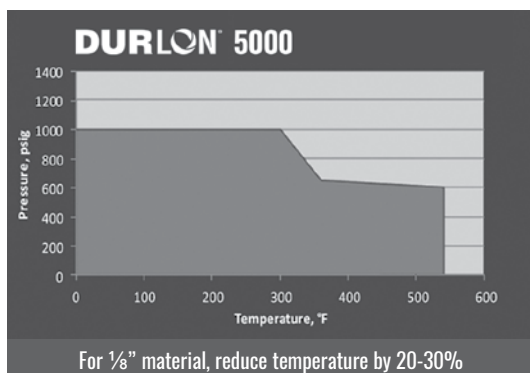

Physical Properties

Color	Light Green
Fiber System	Inorganic
Binder	NBR
Temperature:	
Min	-40°C (-40°F)
Max	288°C (550°F)
Continuous, Max	232°C (450°F)
Pressure, Max, bar (psi)	69 (1,000)
Density, g/cc (lbs/ft ³)	1.7 (106)
Compressibility, %	7-17
Recovery, %	40
Creep Relaxation, %	25
Tensile Strength, MPa (psi)	10.3 (1,500)
Nitrogen Sealability ASTM 2378, cc/min	0.05
Fluid Resistance, ASTM F146 IRM 903 Oil 5hrs at 300°F	
Thickness Increase, %	0-15
Weight Increase, %	10
ASTM Fuel B 5hrs at 70°F	
Thickness Increase, %	0-10
Weight Increase, %	10
Flexibility, ASTM F147	10x

Note: ASTM properties are based on 1/16" sheet thickness, except ASTM F38 which is based on 1/32" sheet thickness. This is a general guide only and should not be the sole means of accepting or rejecting this material. The data listed here falls within the normal range of product properties, but should not be used to establish specifications limits nor used alone as the basis of design. For applications above Class 300, contact our technical department.



DURLON®

7900/7925/7950

Aramid with NBR Rubber Binder
Compressed Non-Asbestos Gasket Material
ASTM F104: F712120-A9B3E22K5L151M5

Durlon® 7900/7925/7950 are an economy grade general service gasket sheet material made with NBR (Nitrile Butadiene Rubber) binder for mild service in piping and equipment with applications in steam, hydrocarbons and refrigerants and an alternative when temperature and pressure conditions are below 500°F (260°C) and 1,200 psig (See PxT chart below for validation).

INDUSTRY APPLICATIONS:

- Chemical Processing
- General Industry
- Mining
- OEM Services
- Rail-Tank Car

Gasket Factors	1/16"	1/8"
m	3.0	3.2
Y psi (MPa)	3,347 (23.1)	3,385 (23.3)
G _b psi (MPa)	497 (3.4)	486 (3.4)
a	0.226	0.276
G _s psi (MPa)	3 (0.02)	0.4 (0.003)

Certifications

California Proposition 65	Compliant
RoHS Reach Declaration	Compliant

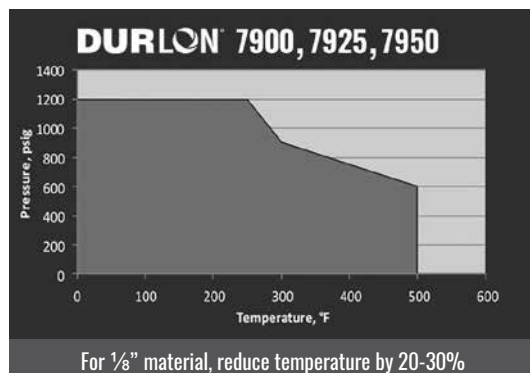

Physical Properties

Color 7900/7925/7950	Off White/Green/Blue
Fiber System	Aramid/Inorganic
Binder	NBR
Temperature:	
Min	-40°C (-40°F)
Max	371°C (700°F)
Continuous, Max	260°C (500°F)
Pressure, Max, bar (psi)	83 (1,200)
Density, g/cc (lbs/ft ³)	1.7 (106)
Compressibility, %	7-17
Recovery, %	≥40
Creep Relaxation, %	20
Tensile Strength, MPa (psi)	11 (1,600)
Nitrogen Sealability ASTM 2378, cc/min	0.05
Fluid Resistance, ASTM F146 IRM 903 Oil 5hrs at 300°F	
Thickness Increase, %	0-15
Weight Increase, %	15
ASTM Fuel B 5hrs at 70°F	
Thickness Increase, %	0-10
Weight Increase, %	12
Flexibility, ASTM F147	10x

Note: ASTM properties are based on 1/16" sheet thickness, except ASTM F38 which is based on 1/32" sheet thickness. This is a general guide only and should not be the sole means of accepting or rejecting this material. The data listed here falls within the normal range of product properties, but should not be used to establish specifications limits nor used alone as the basis of design. For applications above Class 300, contact our technical department.



DURLON[®] 7910



Aramid with NBR Rubber Binder Compressed Non-Asbestos Gasket Material ASTM F104: F712120-A9B3E22K5L151M5

As a quality, commercial grade compressed sheet gasket material, Durlon[®] 7910 was specifically developed to meet the requirement of NSF/ANSI 61 (Certification for water treatment products that are manufactured, distributed or sold in North America) for potable water application 23°C (73°F) to commercial hot 82°C (180°F).

INDUSTRY APPLICATIONS:

- General Industry
- OEM Services
- Water & Wastewater

BENEFIT:

Durlon[®] 7910 has a strong dielectric rating, making it ideal for isolation kit applications where compressed fiber sheet gaskets can be utilized.

Durlon[®] 7910 is manufactured by Durabla[®] Canada Ltd.

Gasket Factors	1/16"	1/8"
m	1.5	1.5
Y psi (MPa)	2,416 (16.7)	3,576 (24.7)
G _b psi (MPa)	502 (3.5)	736 (5.1)
a	0.289	0.237
G _s psi (MPa)	0.001 (0)	9.1 (0.131)

Certifications	
NSF/ANSI 61	Certified to meet requirement of NSF/ANSI 61 for potable water application at 23°C (73°F) to commercial hot to 82°C (180°F)
RoHS Reach Declaration	Compliant

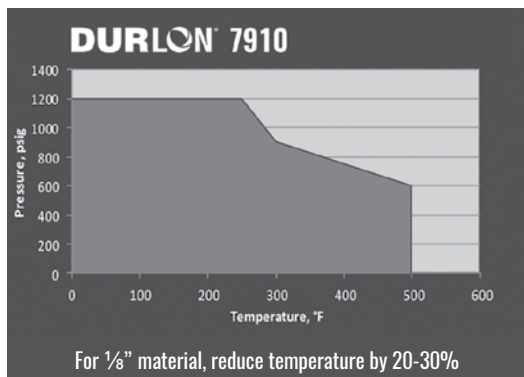

NSF Certified: NSF International is a global independent organization that writes standards and protocols, and tests and certifies products for the food, water and consumer goods industries to minimize adverse health effects and protect the environment. www.nsf.org

Physical Properties	
Color	White
Fiber System	Aramid/Inorganic
Binder	NBR
Temperature: Min Max Continuous, Max	-40°C (-40°F) 371°C (700°F) 260°C (500°F)
Pressure, Max, bar (psi)	83 (1,200)
Density, g/cc (lbs/ft ³)	1.7 (106)
Compressibility, %	9-19
Recovery, %	40
Creep Relaxation, %	25
Tensile Strength, MPa (psi)	11 (1,600)
Nitrogen Sealability ASTM 2378, cc/min	0.05
Fluid Resistance, ASTM F146 IRM 903 Oil 5hrs at 300°F Thickness Increase, % Weight Increase, % ASTM Fuel B 5hrs at 70°F Thickness Increase, % Weight Increase, %	0-15 15 0-10 12
Flexibility, ASTM F147	10x
Dielectric Breakdown ASTM D149, kV/mm (V/mil)	11.0 (279)

Note: ASTM properties are based on 1/16" sheet thickness, except ASTM F38 which is based on 1/32" sheet thickness. This is a general guide only and should not be the sole means of accepting or rejecting this material. The data listed here falls within the normal range of product properties, but should not be used to establish specifications limits nor used alone as the basis of design. For applications above Class 300, contact our technical department.



DURLON®

8300

Carbon Fiber with NBR Rubber Binder
Compressed Non-Asbestos Gasket Material
ASTM F104: F712120-A9B3E22K5L311M5

Durlon® 8300 is a premium grade compressed sheet gasket material that is excellent in steam and hydrocarbon services for the refining, petrochemical, and power generation industries. This gasket material is designed to handle the extreme pressure and temperature applications that include oil, water, mild alkalis, mild acids and solvents.

INDUSTRY APPLICATIONS:

- Chemical Processing
- General/Heavy Industry
- Mining
- OEM Services
- Oil & Gas
- Petrochemical
- Power Generation
- Refining

Gasket Factors	1/16"	1/8"
m	3.7	3.0
Y psi (MPa)	3,515 (24.2)	4,014 (27.7)
G _b psi (MPa)	512 (3.5)	460 (3.2)
a	0.355	0.313
G _s psi (MPa)	13 (0.09)	0.427 (.003)

Certifications	
API 6FB, 4th Edition Fire Test	Passed
California Proposition 65	Compliant
RoHS Reach Declaration	Compliant

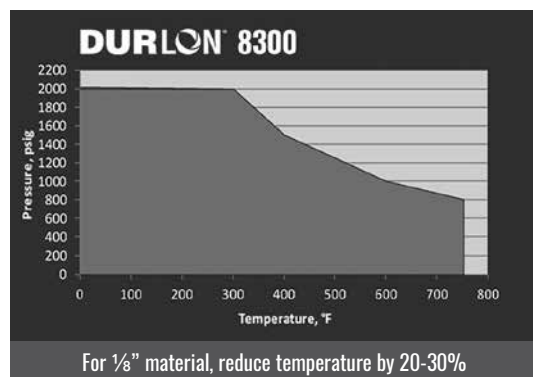

Note: ASTM properties are based on 1/16" sheet thickness, except ASTM F38 which is based on 1/32" sheet thickness. This is a general guide only and should not be the sole means of accepting or rejecting this material. The data listed here falls within the normal range of product properties, but should not be used to establish specifications limits nor used alone as the basis of design. For applications above Class 300, contact our technical department.

Physical Properties

Color	Black
Fiber System	Carbon
Binder	NBR
Temperature:	
Min	-40°C (-40°F)
Max	482°C (900°F)
Continuous, Max	343°C (650°F)
Pressure, Max, bar (psi)	139 (2,000)
Density, g/cc (lbs/ft ³)	1.6 (100)
Compressibility, %	8-16
Recovery, %	50
Creep Relaxation, %	18
Tensile Strength, MPa (psi)	12.4 (1,800)
Nitrogen Sealability ASTM 2378, cc/min	0.05
Fluid Resistance, ASTM F146 IRM 903 Oil 5hrs at 300°F	
Thickness Increase, %	0-10
Weight Increase, %	10
ASTM Fuel B 5hrs at 70°F	
Thickness Increase, %	0-10
Weight Increase, %	12
Flexibility, ASTM F147	10x
Volume Resistivity ASTM D257, ohm-cm	5.0 x 10 ⁹
Dielectric Breakdown ASTM D149, kV/mm (V/mil)	0.04 (1)

DURLON®

8400

Phenolic Fiber with NBR Rubber Binder
Compressed Non-Asbestos Gasket Material
ASTM F104: F712120-A9B4E22K5L911M5

With an extremely wide pH application range (2-13 at room temp.) Durlon® 8400 can be used in process piping and equipment in chemical, pulp & paper and other general industrial applications. A unique high-performance compressed sheet, Durlon® 8400 is an excellent gasket material for use in steam, mild caustics and acids.

INDUSTRY APPLICATIONS:

- Chemical Processing
- Food & Beverage
- General/Heavy Industry
- Mining
- OEM Services
- Power Generation
- Pulp & Paper
- Water & Wastewater

BENEFIT:

Durlon® 8400 has a strong dielectric rating, making it ideal for isolation kit applications where compressed fiber sheet gaskets can be utilized.

Gasket Factors	1/16"	1/8"
m	2.9	4.5
Y psi (MPa)	2,410 (16.6)	3,967 (27.4)
G _b psi (MPa)	380 (2.6)	391 (2.7)
a	0.311	0.321
G _s psi (MPa)	0.01 (.001)	0.014 (.001)

Certifications	
California Proposition 65	Compliant
RoHS Reach Declaration	Compliant

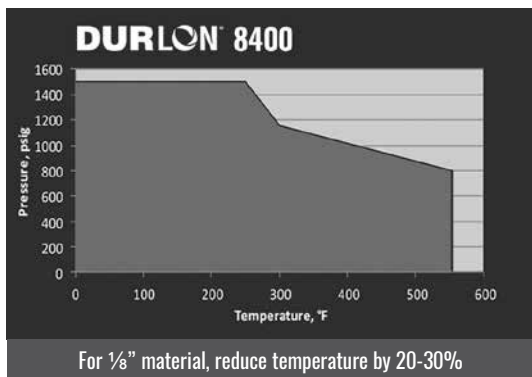

Note: ASTM properties are based on 1/16" sheet thickness, except ASTM F38 which is based on 1/32" sheet thickness. This is a general guide only and should not be the sole means of accepting or rejecting this material. The data listed here falls within the normal range of product properties, but should not be used to establish specifications limits nor used alone as the basis of design. For applications above Class 300, contact our technical department.

Physical Properties	
Color	Gold
Fiber System	Phenolic
Binder	NBR
Temperature:	
Min	-40°C (-40°F)
Max	427°C (800°F)
Continuous, Max	290°C (554°F)
Pressure, Max, bar (psi)	103 (1,500)
Density, g/cc (lbs/ft ³)	1.7 (106)
Compressibility, %	8-16
Recovery, %	50
Creep Relaxation, %	25
Tensile Strength, MPa (psi)	12.4 (1,800)
Nitrogen Sealability ASTM 2378, cc/min	0.03
Fluid Resistance, ASTM F146 IRM 903 Oil 5hrs at 300°F Thickness Increase, % Weight Increase, % ASTM Fuel B 5hrs at 70°F Thickness Increase, % Weight Increase, %	0-15 15 0-10 15
Flexibility, ASTM F147	8x
Volume Resistivity ASTM D257, ohm-cm	3.1 x 10 ¹³
Dielectric Breakdown ASTM D149, kV/mm (V/mil)	14.6 (371)

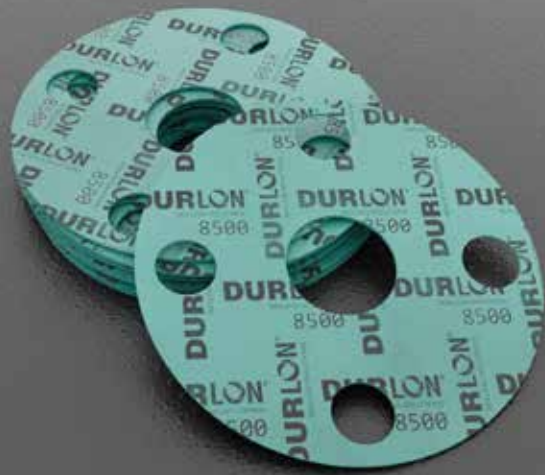

DURLON® 8500

Aramid/Inorganic with NBR Rubber Binder
Compressed Non-Asbestos Gasket Material
ASTM F104: F712120-A9B3E12K5L151M6

A high performance compressed gasket material for use in process industries including pulp & paper, food & beverage, pharmaceutical, hydrocarbon, chemical, refinery and general industry. Durlon® 8500 is suitable for oils, water, steam, new generation refrigerants, dilute acids and alkalis, and many other liquids and gases.

INDUSTRY APPLICATIONS:

- Chemical Processing
- Water & Wastewater
- Petrochemical
- Food & Beverage
- General/Heavy Industry
- Refining
- Mining
- OEM Services

Gasket Factors	1/16"	1/8"
m	2.7	4.2
Y psi (MPa)	2,359 (16.3)	2,931 (20.2)
G _b psi (MPa)	650 (4.5)	400 (2.8)
a	0.33	0.35
G _s psi (MPa)	200 (1.4)	20 (0.1)

Certifications	
California Prop 65	Compliant
RoHS Reach Declaration	Compliant
API 6FB Fire Test	With avg. temp. >650°C, 30 mins, 40 bar, 1 ml (inch/min.) Max allowable leakage
FDA	Conforms to the requirements of 21 CFR 177.2600
ABS	Tier 2, PDA Issued

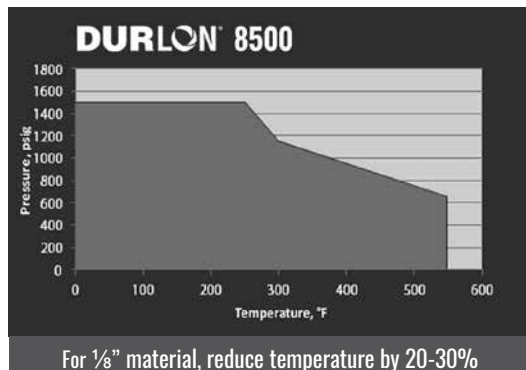

Note: ASTM properties are based on 1/16" sheet thickness, except ASTM F38 which is based on 1/32" sheet thickness. This is a general guide only and should not be the sole means of accepting or rejecting this material. The data listed here falls within the normal range of product properties, but should not be used to establish specifications limits nor used alone as the basis of design. For applications above Class 300, contact our technical department.

Physical Properties

Color	Green
Fiber System	Aramid/ Inorganic
Binder	NBR
Temperature: Min Max Continuous, Max	-40°C (-40°F) 371°C (700°F) 287°C (548°F)
Pressure, Max, bar (psi)	103 (1,500)
Density, g/cc (lbs/ft³)	1.7 (106)
Compressibility, %	8-16
Recovery, %	50
Creep Relaxation, %	20
Tensile Strength, MPa (psi)	13.8 (2,000)
Nitrogen Sealability, ASTM 2378, cc/min	0.03
Fluid Resistance, ASTM F146 IRM 903 Oil 5hrs at 300°F Thickness / Weight Increase, % ASTM Fuel B 5hrs at 70°F Thickness / Weight Increase, %	0-15 / 15 0-10 / 10
Flexibility, ASTM F147	10x
Volume Resistivity, ASTM D257, ohm-cm	4.2 x 10 ¹³
Dielectric Breakdown ASTM D149, kV/mm (V/mil)	11.7 (297)

BENEFIT: Durlon® 8500 has a strong dielectric rating, making it ideal for isolation kit applications where compressed fiber sheet gaskets are used.

DURLON®

8600

Aramid/Inorganic with SBR Rubber Binder
Compressed Non-Asbestos Gasket Material
ASTM F104: F712440-A9B3E24K5L152M5

Durlon® 8600 is a quality compressed sheet gasket material for use in process industries including pulp & paper, power, petrochemical as well as general industry where a “white” gasket material is often required when working with food & beverage, pharmaceutical and plastics.

INDUSTRY APPLICATIONS:

- Chemical Processing
- Food & Beverage
- General Industry
- Mining
- OEM Services
- Water & Wastewater

Gasket Factors	1/16"	1/8"
m	2.9	4.6
Y psi (MPa)	2,540 (17.5)	3,200 (22.1)
G _b psi (MPa)	343 (2.4)	866 (5.9)
a	0.325	0.273
G _s psi (MPa)	0.3 (0.002)	37 (0.255)

Certifications

California Proposition 65	Compliant
RoHS Reach Declaration	Compliant

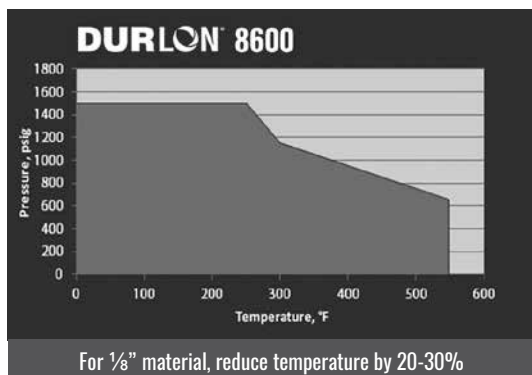

Note: ASTM properties are based on 1/16" sheet thickness, except ASTM F38 which is based on 1/32" sheet thickness. This is a general guide only and should not be the sole means of accepting or rejecting this material. The data listed here falls within the normal range of product properties, but should not be used to establish specifications limits nor used alone as the basis of design. For applications above Class 300, contact our technical department.

Physical Properties

Color	White
Fiber System	Aramid/Inorganic
Binder	SBR
Temperature:	
Min	-40°C (-40°F)
Max	371°C (700°F)
Continuous, Max	287°C (548°F)
Pressure, Max, bar (psi)	103 (1,500)
Density, g/cc (lbs/ft ³)	1.7 (106)
Compressibility, %	8-16
Recovery, %	45
Creep Relaxation, %	20
Tensile Strength, MPa (psi)	12.4 (1,800)
Nitrogen Sealability ASTM 2378, cc/min	0.05
Fluid Resistance, ASTM F146 IRM 903 Oil 5hrs at 300°F	
Thickness Increase, %	15-30
Weight Increase, %	30
ASTM Fuel B 5hrs at 70°F	
Thickness Increase, %	5-20
Weight Increase, %	30
Flexibility, ASTM F147	8x
Volume Resistivity ASTM D257, ohm-cm	4.2 x 10 ¹³
Dielectric Breakdown ASTM D149, kV/mm (V/mil)	11.7 (297)



DURLON®

8700

Aramid/Inorganic with CR Rubber Binder
Compressed Non-Asbestos Gasket Material
ASTM F104: F712330-A9B5E45K5L153M5

Durlon® 8700 is a high performance gasket material for use in processes requiring a neoprene (CR) bonded sheet and has excellent hand and die cutting characteristics. This product has excellent resistance to oils, non-aromatic solvents and many refrigerants.

INDUSTRY APPLICATIONS:

- Chemical Processing
- General Industry
- Mining
- OEM Services
- Oil & Gas

Gasket Factors	1/16"	1/8"
m	3.1	5
Y psi (MPa)	3,127 (21.6)	4,000 (27.6)
G _b psi (MPa)	546 (3.8)	758 (5.2)
a	0.455	0.34
G _s psi (MPa)	12 (0.083)	0.01 (0.0001)

Certifications

California Proposition 65	Compliant
RoHS Reach Declaration	Compliant

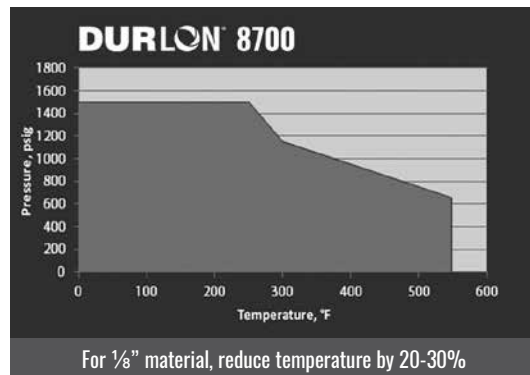

Note: ASTM properties are based on 1/16" sheet thickness, except ASTM F38 which is based on 1/32" sheet thickness. This is a general guide only and should not be the sole means of accepting or rejecting this material. The data listed here falls within the normal range of product properties, but should not be used to establish specifications limits nor used alone as the basis of design. For applications above Class 300, contact our technical department.

Physical Properties

Color	Blue
Fiber System	Aramid/Inorganic
Binder	CR
Temperature:	
Min	-40°C (-40°F)
Max	371°C (700°F)
Continuous, Max	287°C (548°F)
Pressure, Max, bar (psi)	103 (1,500)
Density, g/cc (lbs/ft³)	1.7 (106)
Compressibility, %	8-16
Recovery, %	45
Creep Relaxation, %	20
Tensile Strength, MPa (psi)	10.3 (1,500)
Nitrogen Sealability ASTM 2378, cc/min	0.05
Fluid Resistance, ASTM F146 IRM 903 Oil 5hrs at 300°F	
Thickness Increase, %	10-15
Weight Increase, %	20
ASTM Fuel B 5hrs at 70°F	
Thickness Increase, %	5-20
Weight Increase, %	20
Flexibility, ASTM F147	8x
Volume Resistivity ASTM D257, ohm-cm	4.2 x 10 ¹³
Dielectric Breakdown ASTM D149, kV/mm (V/mil)	11.7 (297)

DURLON®

8900

Aramid-Graphite with NBR Rubber Binder
Compressed Non-Asbestos Gasket Material
ASTM F104: F712120-A9B2E21L101M6

A premium grade material for service conditions to 496°C (925°F) and continuous operating temperatures of -40°C to 400°C (-40°F to 752°F). Durlon® 8900 is ideal for saturated and superheated steam, oil, dilute acids and alkalis, hydrocarbons and solvents.

INDUSTRY APPLICATIONS:

- Chemical Processing
- Food & Beverage
- Mining
- Water & Wastewater
- General Industry
- OEM Services
- Petrochemical
- Refining
- Oil & Gas

Gasket Factors	1/16"	1/8"
m	4.8	7.3
Y psi (MPa)	4,851 (33.4)	3,730 (25.7)
G _b psi (MPa)	915 (6.3)	567 (3.9)
a	0.428	0.556
G _s psi (MPa)	0.02 (0.0001)	0.26 (0.002)

Certifications	
ANSI/API 607 Fire Test	6th Ed., Zero leakage
RoHS Reach Declaration	Compliant

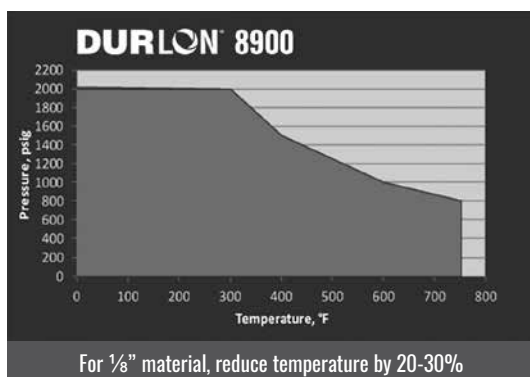

Note: ASTM properties are based on 1/16" sheet thickness, except ASTM F38 which is based on 1/32" sheet thickness. This is a general guide only and should not be the sole means of accepting or rejecting this material. The data listed here falls within the normal range of product properties, but should not be used to establish specifications limits nor used alone as the basis of design. For applications above Class 300, contact our technical department.

Physical Properties	
Color	Black
Fiber System	Aramid/Inorganic
Binder	NBR
Temperature:	
Min	-40°C (-40°F)
Max	496°C (925°F)
Continuous, Max	400°C (752°F)
Pressure, Max, bar (psi)	138 (2,000)
Density, g/cc (lbs/ft ³)	1.6 (100)
Compressibility, %	7-17
Recovery, %	50
Creep Relaxation, %	15
Tensile Strength, MPa (psi)	13.8 (2,000)
Nitrogen Sealability ASTM 2378, cc/min	0.2
Fluid Resistance, ASTM F146 IRM 903 Oil 5hrs at 300°F	
Thickness Increase, %	3
Weight Increase, %	15
ASTM Fuel B 5hrs at 70°F	
Thickness Increase, %	4
Weight Increase, %	12
Flexibility, ASTM F147	12x
Volume Resistivity ASTM D257, ohm-cm	4.01 x 10 ⁰
Stress Relaxation, DIN 52913 @ 7,252psi (50 MPa)	
16 hr @ 347°F (175°C)	6,500 (44.8) Min.
16 hr @ 572°F (300°C)	6,000 (41.4) Min.



PTFE (Polytetrafluoroethylene)

Durlon® filled PTFE gaskets/sheets are exclusively manufactured at Triangle Fluid Controls Ltd. in Belleville, Ontario, Canada. Our compression molded and skived manufacturing process allows for the best control of physical properties and performance characteristics compared to other manufacturing processes.

PTFE (polytetrafluoroethylene) has excellent chemical resistance and its unique properties lends itself well for use in a variety of industrial, manufacturing, and engineering facilities. The superb chemical resistance and tolerance to vast temperature gradients has not only improved the efficiency of many industries, but the safety for the employees that work around those conditions as well.

ADVANTAGES OF USING FILLED PTFE COMPOUNDS:

- Excellent chemical resistance
- Wide range of service temperature
- Excellent dielectric properties
- Non-stick, low friction
- No embrittlement or aging
- Smooth surface finish can be achieved
- Non-wetting
- Outstanding corrosion protection
- Electrical insulation
- High thermal stability and flame resistance
- Resistance to weathering
- Food grade compliant

HYDROGEN FLUORIDE RESISTANCE

Hydrogen fluoride is a critical chemical used in many industries, including metal manufacturing and petroleum production. It's also highly reactive and corrosive.

Given the serious health and environmental hazards associated with hydrogen fluoride, the Environmental Protection Agency (EPA) requires immediate reporting of any leaks; even a minor leak can result in plant shutdown, significantly affecting overall operations, downtime, labor needs, and costs.

The Hydrogen Fluoride Industry Practices Institute (HFIP) publishes a Materials of Construction Guideline to help ensure the safest possible industrial use of hydrogen fluoride. Within this guide, PTFE is listed as a safe sealant for hydrogen fluoride.

COMMON GRADES OF PTFE:

Virgin PTFE

“Virgin PTFE” (PTFE without a filler) is one of the most chemically inert materials known and is used in many different applications and industries.

Glass Filled PTFE

Virgin PTFE with 20-30% Glass filler which dramatically increases compressive strength and lowers deformation under load.

Carbon Filled PTFE

The addition of carbon to PTFE increases the compressive strength

and wear resistance. It provides good thermal conductivity and low permeability.

Barium Sulfate Filled PTFE

The addition of barium sulfate to PTFE offers excellent resistance to cold flow and creep, bolt-load retention, outstanding dimensional stability under thermal stress, and resists a variety of chemicals.

PROCESSING PTFE

Because PTFE is a thermoplastic and due to its high viscosity, it cannot be processed using conventional polymer processing techniques. PTFE is processed by cold shaping and followed by heat treatment (sintering) during which polymer particles fuse to form a solid molding.



PTFE is highly resistant to corrosion due to its chemical inertness. Unfortunately, that same chemical inertness prevents PTFE from being cross-linked like elastomers and is subject to the phenomenon of cold flow – otherwise known as “creep”. To reduce and diminish cold flow, additives are introduced during the preparation of PTFE compounds. Glass fillers found in Durlon® 9000 and 9000N gaskets, not only reduce creep but also maintain chemical inertness against aggressive and caustic chemicals but are still considered safe for use by food, drug, and medical services.



SKIVING

Durlon® PTFE is manufactured via skived method, vs our competitors that utilize the HS-10 calendar method.

The calendered method has some downfalls such as sheet thickness tolerance and perhaps the main fall-back is that the sheet length can only be as long as the circumference of the roll - in most cases this is only 60” (1500mm).

Durlon® skived PTFE benefits feature tighter sheet tolerances and sheet lengths that can be cut in 60” increments. We offer 1/8” sheets in 60” x 60”, 60” x 120”, 60” x 180”, 60” x 300” and up to 60” x 110 linear feet if you truly required it. The benefit of longer or continual sheets can result in an increase of up to 30%* gasket cutting yield. *Based on gaskets size/qty.

Through our 3rd party testing of our Durlon® PTFE vs competitor calendered sheets, we can dispel the following myths about skived material: stratification of fillers, uneven disbursement of fillers, and tensile strength variation due to unidirectional compression loading.*Ask to see our data.



DURLON® 9000

Inorganic Filler with Pure PTFE Resins
Filled PTFE Gasket Material
ASTM F104: F452111-A9B5E11K6M6

Durlon® 9000 is for use in general industrial applications where resistance to highly aggressive chemicals is required. In addition, the shape of the fillers does not allow wicking which can cause corrosion on flange surfaces.

INDUSTRY APPLICATIONS:

- Chemical Processing
- Food & Beverage
- General/Heavy Industry
- Marine
- Mining
- OEM Services
- Oil & Gas
- Petrochemical
- Pharmaceutical
- Power Generation
- Pulp & Paper
- Refining
- Water & Wastewater

BENEFIT:

Durlon® 9000 has a strong dielectric rating, making it ideal for isolation kit applications where PTFE sheet gaskets can be utilized.

Certifications

API 6FA* , 3rd Edition Fire Test	Passed
USP for Plastic Class VI	Met requirements - 121°C (250°F)
FDA	Conforms to required 21 CFR 177.1550
TA-luft (VDI Guideline 2440)	Approved Material
ABS-PDA & Pamphlet 95	Approved Material, chlorine institute
(EC) 1935/2004 & EU (10/2011)	Approved Material

*6 inch Class 300. The test fixture was subjected to an external flame of 875°C (1607°F) average for 30 minutes. The measured leakage was 1.8 ml/min, where the max allowable limit is 1200 ml/min.

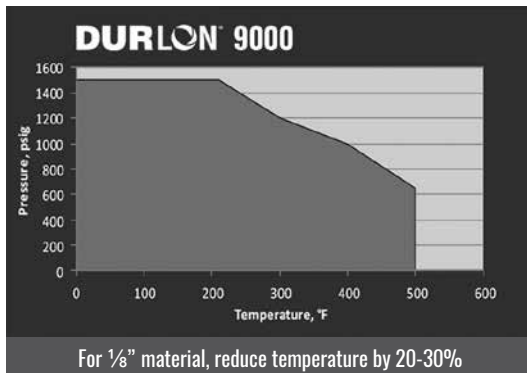

Note: ASTM properties are based on 1/16" sheet thickness, except ASTM F38 which is based on 1/32" sheet thickness. This is a general guide only and should not be the sole means of accepting or rejecting this material. The data listed here falls within the normal range of product properties, but should not be used to establish specifications limits nor used alone as the basis of design. For applications above Class 300, contact our technical department.

Physical Properties

Color	Blue
Filler System	Inorganic
Temperature: Min Max Continuous, Max	-212°C (-350°F) 271°C (520°F) 260°C (500°F)
Pressure, Max, bar (psi)	103 (1,500)
Density, g/cc (lbs/ft ³)	2.2 (138)
Compressibility, %	8-16
Recovery, %	40
Creep Relaxation, %	30
Tensile Strength, MPa (psi)	13.8 (2,000)
Nitrogen Sealability ASTM 2378, cc/min	0.01
Leakage, mbar .1 (m .5) TA-Luft (VDI 2440) iBar (14.5 psi) @180°C (392°F)	7.55 x 10 ⁻⁶
Volume Resistivity ASTM D257, ohm-cm	1.0 x 10 ⁵
Dielectric Breakdown ASTM D149, kV/mm (V/mil)	16 (406)

Gasket Factors	1/16"	1/8"
m	2.2	4.6
Y psi (MPa)	1,937 (13.4)	1,639 (11.3)
G _b psi (MPa)	639 (4.4)	495 (3.4)
a	0.220	0.262
G _s psi (MPa)	55 (0.379)	65 (0.448)

DURLON® 9000N

Inorganic Filler with Pure PTFE Resins
Filled PTFE Gasket Material
ASTM F104: F452111-A9B5E11K6M6

Durlon® 9000N is for use in general industrial applications where resistance to highly aggressive chemicals is required. In addition, the shape of the fillers does not allow wicking, which can cause corrosion on flange surfaces.

INDUSTRY APPLICATIONS:

- Chemical Processing
- Food & Beverage
- General Industry
- Marine
- Mining
- OEM Services
- Oil & Gas
- Pharmaceutical
- Power Generation
- Pulp & Paper
- Water & Wastewater

Certifications

USP Class VI	Met requirements for Plastic Class VI - 121°C (250°F)
FDA	Conforms to the requirements of 21 CFR 177.1550 for food and drug contact
ABS-PDA & Pamphlet 95	Approved Material, chlorine institute
(EC) 1935/2004 & EU (10/2011)	Approved Material

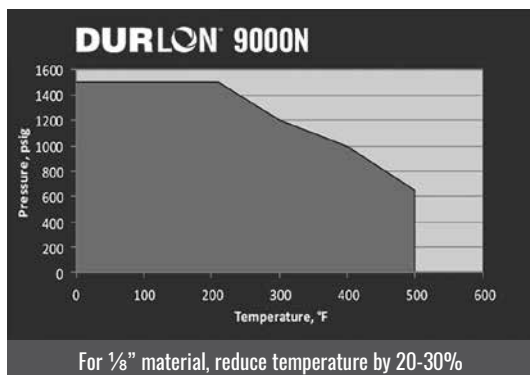

Note: ASTM properties are based on 1/16" sheet thickness, except ASTM F38 which is based on 1/32" sheet thickness. This is a general guide only and should not be the sole means of accepting or rejecting this material. The data listed here falls within the normal range of product properties, but should not be used to establish specifications limits nor used alone as the basis of design. For applications above Class 300, contact our technical department.

Physical Properties

Color	White
Filler System	Inorganic
Temperature:	
Min	-212°C (-350°F)
Max	271°C (520°F)
Continuous, Max	260°C (500°F)
Pressure, Max, bar (psi)	103 (1,500)
Density, g/cc (lbs/ft ³)	2.2 (138)
Compressibility, %	8-16
Recovery, %	40
Creep Relaxation, %	30
Tensile Strength, MPa (psi)	13.8 (2,000)
Nitrogen Sealability ASTM 2378, cc/min	0.01
Volume Resistivity ASTM D257, ohm-cm	1.0 x 10 ⁵
Dielectric Breakdown ASTM D149, kV/mm (V/mil)	16 (406)

Gasket Factors	1/16"	1/8"
m	2.2	4.6
Y psi (MPa)	1,937 (13.4)	1,639 (11.3)
G _b psi (MPa)	639 (4.4)	495 (3.4)
a	0.220	0.262
G _s psi (MPa)	55 (0.379)	65 (0.448)



Durlon® 9002 is an adaptation of the original glass-filled formula to better meet extreme cryogenic demands and is readily available through the standard manufacturing process and requires no secondary heat or cleansing treatments prior to gasket cutting. Once gaskets are cut, traditional oxygen cleaning standards must be applied for safety.

Available as oxygen cleaned gaskets, bagged, labeled, and sealed according to the European Industrial Gases Association standard for Cleaning of Equipment for Oxygen Service.

INDUSTRY APPLICATIONS:

- Chemical Processing
- Pharmaceutical
- Marine (LNG)
- Cryogenic

Certifications

FDA	Conforms to the requirements of 21 CFR 177.1550 for food & drug contact
BAM Oxygen Service: Gaseous & Liquid (Test Report)	Up to 260°C (500°F) at 52 bar (754 psi)
LOX Mechanical Impact (ASTM G86 & ISO 21010)	Zero reactions out of 20 at a test reaction frequency of 0%
RoHS Reach Declaration	Compliant
DNV-GL	Approved Material

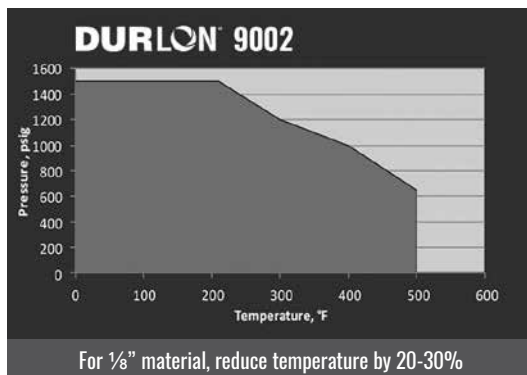

Note: ASTM properties are based on 1/16" sheet thickness, except ASTM F38 which is based on 1/32" sheet thickness. This is a general guide only and should not be the sole means of accepting or rejecting this material. The data listed here falls within the normal range of product properties, but should not be used to establish specifications limits nor used alone as the basis of design. For applications above Class 300, contact our technical department.

DURLON® 9002

Inorganic Filler with Pure PTFE Resins
Filled PTFE Gasket Material
ASTM F104: F452111-A9B5E11K6M6

Physical Properties

Color	Blue
Filler System	Inorganic
Temperature:	
Min	-212°C (-350°F)
Max	271°C (520°F)
Continuous, Max	260°C (500°F)
Pressure, Max, bar (psi)	103 (1,500)
Density, g/cc (lbs/ft ³)	2.2 (138)
Compressibility, %	8-16
Recovery, %	40
Creep Relaxation, %	30
Tensile Strength, MPa (psi)	13.8 (2,000)
Nitrogen Sealability ASTM 2378, cc/min	0.01
Volume Resistivity ASTM D257, ohm-cm	1.0 x 10 ⁵
Dielectric Breakdown ASTM D149, kV/mm (V/mil)	16 (406)

Gasket Factors	1/16"	1/8"
m	2.2	4.6
Y psi (MPa)	1,937 (13.4)	1,639 (11.3)
G _b psi (MPa)	639 (4.4)	495 (3.4)
a	0.220	0.262
G _s psi (MPa)	55 (0.379)	65 (0.448)

DURLON®

9200

Barium Sulfate Filler with Pure PTFE Resins
Filled PTFE Gasket Material
ASTM F104: F451-A9B2M6

Durlon® 9200 is a filled PTFE gasket material used where resistance to highly aggressive chemicals is required. Barium sulfate fillers are homogeneously blended with pure PTFE resins to give Durlon® 9200 its physical and mechanical properties.

INDUSTRY APPLICATIONS:

- Chemical Processing
- Food & Beverage
- General/Heavy Industry
- Marine
- Mining
- OEM Services
- Oil & Gas
- Petrochemical
- Pharmaceutical
- Power Generation
- Pulp & Paper
- Rail Tank Car
- Water & Wastewater

Certifications

FDA	Conforms to the requirements of 21 CFR 177.1550 for food & drug contact
TA-luft (VDI Guideline 2440)	Approved Material
BAM Oxygen Service	Approved Material
ABS-PDA & Pamphlet 95	Approved Material
(EC) 1935/2004 & EU	Approved Material
Blow-Out & DVGW	Approved Material

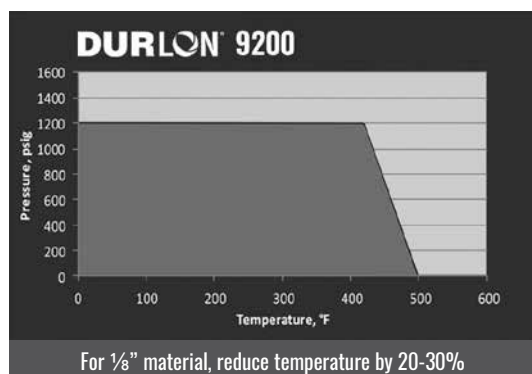

Note: ASTM properties are based on 1/16" sheet thickness, except ASTM F38 which is based on 1/32" sheet thickness. This is a general guide only and should not be the sole means of accepting or rejecting this material. The data listed here falls within the normal range of product properties, but should not be used to establish specifications limits nor used alone as the basis of design. For applications above Class 300, contact our technical department.

Physical Properties

Color	Off White
Filler System	Barium Sulfate
Temperature: Min Max	-268°C (-450°F) 260°C (500°F)
Operating Pressure, bar (psi)	83 (1,203)
Compressibility, %	4-10
Recovery, %	40
Creep Relaxation, %	15
Tensile Strength, MPa (psi)	14 (2,030)
Leakage Rate TA-Luft (VDI 2440), mbar .l/(s.m)	5.9×10^{-7}
Leakage Rate DIN 3535-6 (40bar, N2), ml/min	<0.01
Residual Stress DIN 52913, MPa (psi)	16 (2,320)

Gasket Factors

	2mm (5/64")
m	2
Y psi (MPa)	1500 (10.34)



DURLON® 9400

Carbon Filler with Pure PTFE Resins
Filled PTFE Gasket Material
ASTM F104: F452111-A9B5E11K6M6

Durlon® 9400 is a high performance filled PTFE gasket material designed for use in piping and equipment, chemical, and other general industrial applications where resistance to highly aggressive chemicals (including hydrofluoric acid) is required. Durlon® 9400 can also be used as the gasket of choice for anhydrous hydrogen fluoride (AHF) in railroad tank cars and a good alternative for use in plants where barium sulfate filled PTFE may not be suitable.

Hydrogen fluoride is a critical chemical used in many industries, including metal manufacturing and petroleum production. It's also highly reactive and corrosive. Durlon® 9400 carbon-filled PTFE gaskets are built to endure the harshest exposure to hydrogen fluoride. This gasket provides superior sealing properties, and is both highly durable and flexible.

INDUSTRY APPLICATIONS:

- Chemical Processing
- Food & Beverage
- Marine
- Mining
- OEM Services
- Oil & Gas
- Petrochemical
- Pharmaceutical
- Power Generation
- Pulp & Paper
- Rail Tank Car
- Refining
- Water & Wastewater
- General/Heavy Industry

Certifications

RoHS Reach Declaration	Compliant
HFIPI - Materials of Construction Guideline	Approved Material

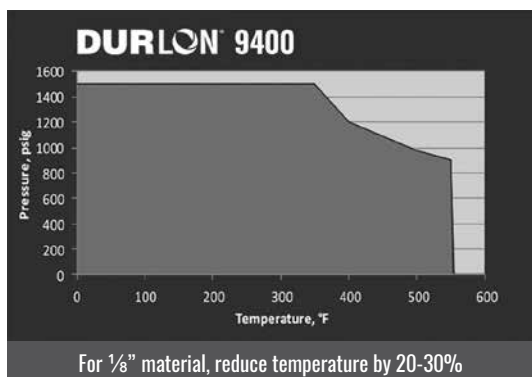

Note: ASTM properties are based on 1/16" sheet thickness, except ASTM F38 which is based on 1/32" sheet thickness. This is a general guide only and should not be the sole means of accepting or rejecting this material. The data listed here falls within the normal range of product properties, but should not be used to establish specifications limits nor used alone as the basis of design. For applications above Class 300, contact our technical department.

Physical Properties

Color	Black
Filler System	Carbon
Temperature:	
Min	-212°C (-350°F)
Max	288°C (550°F)
Continuous, Max	260°C (500°F)
Pressure, Max, bar (psi)	103 (1,500)
Density, g/cc (lbs/ft ³)	2.1 (131)
Compressibility, %	5-12
Recovery, %	40
Creep Relaxation, %	30
Tensile Strength, MPa (psi)	14.5 (2,100)
Nitrogen Sealability ASTM 2378, cc/min	0.01
Volume Resistivity ASTM D257, ohm-cm	61
Dielectric Breakdown ASTM D149, kV/mm (V/mil)	1 (33)

Gasket Factors

	1/16"	1/8"
m	6.8	-
Y psi (MPa)	2,765 (19.1)	-
G _b psi (MPa)	1,701 (11.7)	1,412 (9.7)
a	0.173	0.164
G _s psi (MPa)	99 (0.68)	248 (1.7)

DURLON®

9600

Expanded PTFE
100% Pure PTFE Gasket Material
ASTM F104: F428111-A9B4E11M6

Durlon® 9600 is a biaxially expanded PTFE gasket, made with only pure PTFE resins, designed for use in process piping and equipment, in chemical, pulp and paper, food and beverage, and other general industrial applications, where resistance to highly aggressive chemicals is required.

Durlon® 9600 is also suitable for sealing flanges with irregular surfaces. It will not exhibit the cold flow problems associated with virgin PTFE, or the hardness problems of some filled PTFE products. It has excellent sealability, cuts easily and separates cleanly from flanges after use. This material is FDA compliant, ABS-PDA, USP Class VI, and TA-Luft certified.

INDUSTRY APPLICATIONS:

- Chemical Processing
- Food & Beverage
- OEM Services
- Water & Wastewater
- General/Heavy Industry
- Oil & Gas
- Petrochemical
- Refining

Certifications	
FDA	Conforms to the requirements of 21 CFR 177.1550 for food and drug contact
USP for Plastic Class VI	Met requirements - 121°C (250°F)
RoHS Reach Declaration	Compliant
ABS-PDA Certified	Approved Material
TA-Luft (VDI Guideline 2440)	Approved Material

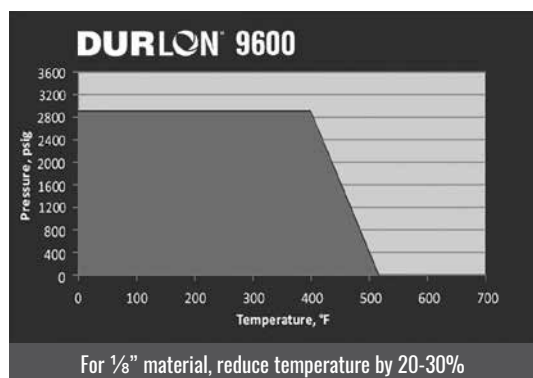

Note: ASTM properties are based on 1/16" sheet thickness, except ASTM F38 which is based on 1/32" sheet thickness. This is a general guide only and should not be the sole means of accepting or rejecting this material. The data listed here falls within the normal range of product properties, but should not be used to establish specifications limits nor used alone as the basis of design. For applications above Class 300, contact our technical department.

Physical Properties	
Color	White
Filler System	Pure PTFE
Temperature:	
Min	-268°C (-450°F)
Max	316°C (600°F)
Continuous, Max	260°C (500°F)
Pressure, Max, bar (psi)	200 (2,900)
Density, g/cc (lbs/ft ³)	0.9 (56.2)
Compressibility, %	50-60
Recovery, %	>10
Creep Relaxation, %	22
Stress Retention DIN 52913 (MPa)	15
Leakage Rate TA-LUFT (VDI 2440), mbar. 1/(s.m)	2.6 x 10 ⁻⁷
Tensile Strength, MPa (psi)	20 (2,800)

Gasket Factors	1/8"
m	2.0
Y psi (MPa)	2,800 (19.3)
G _b psi (MPa)	1,400 (9.65)
a	0.19
G _s psi (MPa)	1.5 (0.01)



DURLON® 9645

Microcellular PTFE with Rigid PTFE core
ASTM F104: F497130E21M4

The Durlon® 9645 product range offers a biaxially-oriented PTFE sheet solution that combines superior chemical resistance with exceptional sealing performance, making it an optimal choice for demanding industrial applications.

Engineered to perform across a broad temperature range from cryogenic conditions up to +260°C, Durlon® 9645 is suitable for handling aggressive media spanning the full pH spectrum (0 to 14). This advanced material is designed for applications requiring minimal creep and reliable seal integrity, particularly in scenarios where low leakage is critical, and conventional PTFE materials fail to meet the requirements.

Durlon® 9645 is designed with controlled microporosity and a closed-cell structure, delivering excellent compressibility and reliable sealability, even at low bolt torque. The compressible PTFE surface layers make Durlon® 9645 ideal for warped, pitted, or scratched flanges, as the microcellular layer conforms effectively to surface irregularities.

The rigid PTFE core minimizes cold flow and creep, significantly enhancing durability and long-term performance. It also improves handleability and simplifies installation, particularly on large-diameter flanges or in hard-to-reach locations. Durlon® 9645 is an excellent choice for low torque applications, such as glass-lined flanges and equipment, where traditional solutions often struggle to perform.

Moreover, Durlon® 9645 is compatible with a wide range of chemicals, including strong acids and aggressive caustics, ensuring versatility across various industries. This material is also a superior alternative to envelope gaskets, offering robust sealing performance with added durability and ease of use.

INDUSTRY APPLICATIONS:

- Chemical Processing
- Mining
- Power Generation
- Food & Beverage
- OEM Services
- Pulp & Paper
- General Industry
- Oil & Gas
- Water & Wastewater
- Marine
- Pharmaceutical

Note: ASTM properties are based on 1/16" sheet thickness, except ASTM F38 which is based on 1/32" sheet thickness. This is a general guide only and should not be the sole means of accepting or rejecting this material. The data listed here falls within the normal range of product properties, but should not be used to establish specifications limits nor used alone as the basis of design. For applications above Class 300, contact our technical department.

Physical Properties	
Color	White
Material	Modified PTFE with rigid PTFE core
Temperature: Min Max	-260°C (-436°F) 260°C (500°F)
Pressure, Max, bar (psi)	60 (870)
Density, g/cc (lbs/ft ³) ASTM 1315	1.3 (81)
Compressibility, % DIN 3535-6	>44
Recovery, % DIN 3535-6	>6.3
Creep, % DIN 3535-6	<26
Leakage, mg·s ⁻¹ ·m ⁻¹ DIN 3535-6	<0.002
pH Range	0-14

Certifications	
FDA	Conforms to the requirements of 21 CFR 177.1550 for food and drug contact
TA-Luft (VDI Guideline 2440)	Approved Material

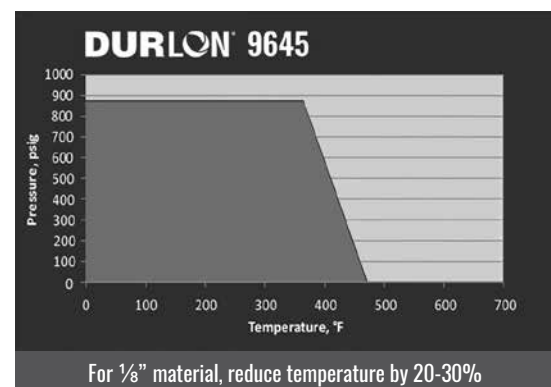



DURLON® Virgin PTFE

100% Pure PTFE Gasket Material

Durlon® Virgin PTFE gasket material is a high performance PTFE product designed for use in piping and equipment in chemical and other general industrial applications where resistance to highly aggressive chemicals (including hydrofluoric acid) is required.

FEATURES:

- better physical properties
- good electrical insulator
- FDA approved

Durlon® Virgin PTFE is made with only pure PTFE resins. It has excellent sealability characteristics, cuts easily and separates cleanly from flanges after use. Durlon® Virgin PTFE demonstrates high dielectric strength.

INDUSTRY APPLICATIONS:

- Chemical Processing
- Food & Beverage
- Pharmaceutical

Gasket Factors	1mm	2mm	3mm
m	3.0	2.5	2.0
Y psi (MPa)	2,842 (19.6)	2,132 (14.7)	2,132 (14.7)

Physical Properties

Color	White
Material	Skived PTFE
Temperature:	
Min	-212°C (-350°F)
Max	260°C (500°F)
Pressure, Max, bar (psi)	86 (1,250)
Density, g/cc (lbs/ft ³)	2.1 (135)
Compressibility, %	12-20
Recovery, %	35-40
Creep Relaxation, %	40
Nitrogen Sealability ASTM 2378, cc/min	0.01
Tensile Strength, MPa (psi)	19.3 (2,800)

Certifications

FDA	Conforms to the requirements of 21 CFR 177.1550 for food and drug contact (Applies to Skived grade only)
RoHS Reach Declaration	Compliant



Durlon® Joint Sealant (PTFE Adhesive) is a highly fibrillated expanded PTFE form-in-place sealant for gasketed joints and conforms to FDA requirements.

Supplied on spools, Durlon® Joint Sealant comes in various thicknesses with a high quality adhesive backing to ease in installation; making it ideal for worn flanges of all sizes and is not dependent on flange dimensions. It exhibits flexibility, compressibility, and stability under high temperature while maintaining high tensile strength. Another feature of Durlon® Joint Sealant is its chemically inert properties which resists creep relaxation, resulting in the maintenance of a tight seal.

Durlon® Joint Sealant is made with only 100% pure PTFE resins and exhibits the same chemical resistance of virgin PTFE.

INDUSTRY APPLICATIONS:

- Chemical Processing
- Marine
- Petrochemical
- Food & Beverage
- Pharmaceutical

Certifications	
FDA	Conforms to the requirements of 21 CFR 177.1550 for food and drug contact
RoHS Reach Declaration	Compliant

Recommended Usage Chart- Imperial (Metric)	
Nominal Pipe Size	Width of Joint Sealant
2" - 4" (5cm - 10cm)	.25" (.6cm)
5" - 8" (13cm - 20cm)	.375" (1cm)
10" - 16" (25cm - 41cm)	.5" (1.3cm)
18" - 24" (46cm - 61cm)	.625" (1.6cm)
26" - 48" (66cm - 122cm)	.75" (1.9cm)
48" (122cm) and higher	1" (2.5cm)

DURLON® Joint Sealant

100% Pure Expanded PTFE Gasket Material

Physical Properties	
Color	White
Temperature: Min Max	-268°C (-450°F) 260°C (500°F)
Pressure, Max, bar (psi)	200 (2,900)
Density, g/cc (lbs/ft³)	0.65 (40.6)
pH range, Room Temp.	0-14

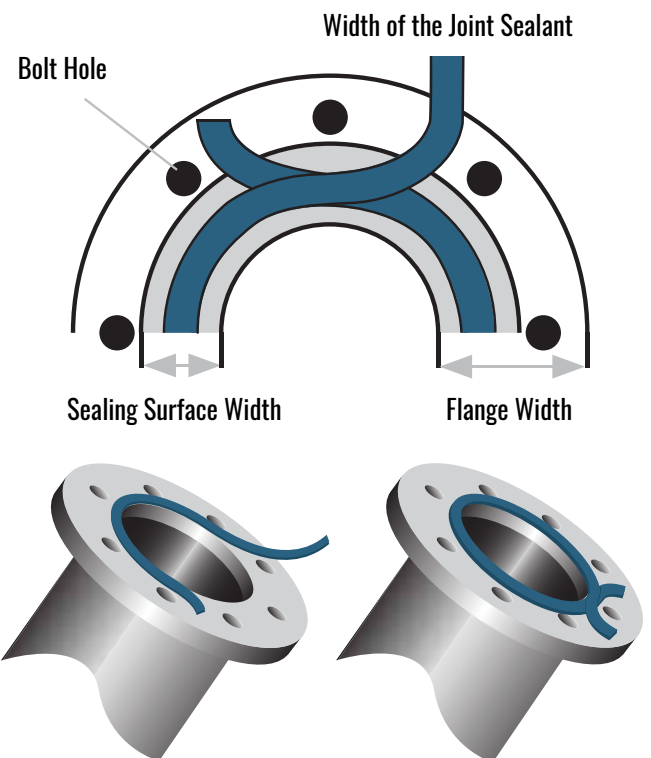

NOTE: Step-by-step "Installation Instructions" downloadable PDF is available at: www.durlon.com/resources/technical-references/

DURLON



**Inorganic Filler with Pure PTFE Resins
Filled PTFE Gasket Material
ASTM F104: F452111-A9B5E11K6M6**



Our next level of manway sealing for the rail car industry features a single “Universal Style” gasket that can accommodate several model sizes. The flexibility of the SecureSnap™ manway gasket enables the user to install the gaskets more quickly than the conventional gasket. Flexible tabs easily snap into the groove bottom, eliminating the need for tight tolerances associated with conventional style gaskets.

The flexibility of the SecureSnap™ manway gasket also renders the gaskets more versatile than the conventional gasket. The SecureSnap™ gasket will accommodate more than one style of manway system (dependent on end user approval) allowing distributors to stock one size of gasket for multiple manway designs, therefore reducing inventory and overall cost.

Physical Properties	
Color	Blue
Filler System	Inorganic
Temperature:	
Min	-212°C (-350°F)
Max	271°C (520°F)
Continuous, Max	260°C (500°F)
Pressure, Max, bar (psi)	103 (1,500)
Density, g/cc (lbs/ft ³)	2.2 (138)
Compressibility, %	8-16
Recovery, %	40
Creep Relaxation, %	30
Tensile Strength, MPa (psi)	13.8 (2,000)
Nitrogen Sealability ASTM 2378, cc/min	0.01
Leakage, mbar .1 (m .5) TA-Luft (VDI 2440) iBar (14.5 psi) @180°C (392°F)	7.55 x 10 ⁻⁶
Volume Resistivity ASTM D257, ohm-cm	1.0 x 10 ⁵
Dielectric Breakdown ASTM D149, kV/mm (V/mil)	16 (406)

Certifications	
API 6FA* , 3rd Edition Fire Test	Passed
USP for Plastic Class VI	Met requirements - 121°C (250°F)
FDA	Conforms to required 21 CFR 177.1550
TA-luft (VDI Guideline 2440)	Approved Material
ABS-PDA & Pamphlet 95	Approved Material, chlorine institute
(EC) 1935/2004 & EU (10/2011)	Approved Material

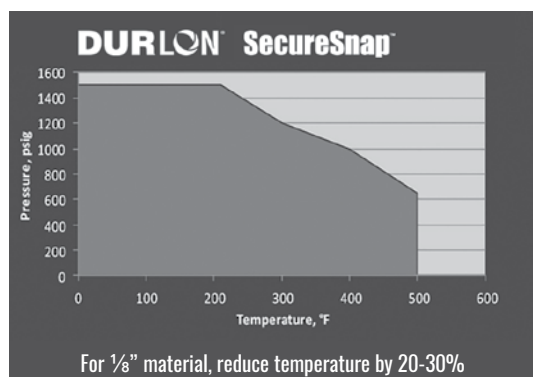

**6 inch Class 300. The test fixture was subjected to an external flame of 875°C (1607°F) average for 30 minutes. The measured leakage was 1.8 ml/min, where the max allowable limit is 1200 ml/min.*

Gasket Factors	1/16"	1/8"
m	2.2	4.6
Y psi (MPa)	1,937 (13.4)	1,639 (11.3)
G _b psi (MPa)	639 (4.4)	495 (3.4)
a	0.220	0.262
G _s psi (MPa)	55 (0.379)	65 (0.448)

Note: ASTM properties are based on 1/16" sheet thickness, except ASTM F38 which is based on 1/32" sheet thickness. This is a general guide only and should not be the sole means of accepting or rejecting this material. The data listed here falls within the normal range of product properties, but should not be used to establish specifications limits nor used alone as the basis of design. For applications above Class 300, contact our technical department.



DURLON® RCA®

Reduced Contact Area Full Face Gasket PTFE & Compressed Non-Asbestos Gasket Material

RCA® is a registered trademark of Gasket Resources Inc.

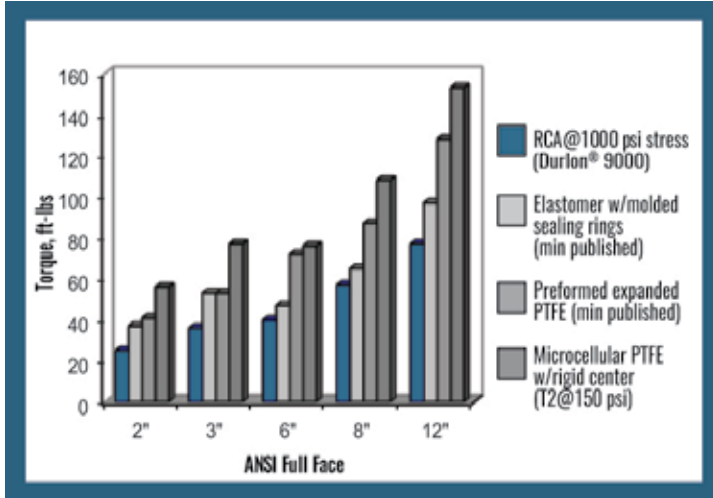

The above illustrates a 3" 150# Full Face gasket using FEA analysis to show the applicable stresses that are being applied to the gasket while bolted up in the flange.

Durlon® RCA® sealing system combined with Durlon® PTFE styles can replace standard full gaskets in FRP, PVC and other non-metallic and metallic pipe flanges where a low stress gasket is required. The RCA® configuration can be cut from standard PTFE & CNA sheets resulting in a cost savings versus other low stress gaskets.

AVAILABLE MATERIALS: 1/16" & 1/8" Durlon® PTFE styles and Compressed Non-Asbestos styles

AVAILABLE SIZES: 1-24" Class 150 Full Face gaskets

- For FRP, PVC, Glass-Lined or steel flanges where a low stress gasket is required
- Reduced contact area, lower sealing stress, and significant cost savings
- Alignment guides included for easy positioning during installation
- Identification tabs extend beyond the flange OD for easy identification once bolted
- Custom sizes and designs are available

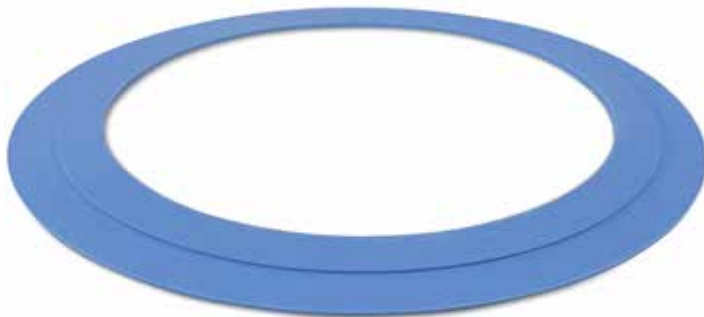

DURLON® 9000 Step Ring Gasket

Used extensively in Sulfuric Acid Plants
often found in Phosphate Refineries

Acid piping systems are designed for many years of continuous operation and are subject to thermal cycling and aggressive chemical corrosion making it important to use the proper gasket.

Our single-piece construction Step Ring Gasket is custom machined from Durlon® 9000 - a filled PTFE gasket material compatible with sulfuric acid in all concentrations, and has excellent physical properties: sealability and recovery from extreme thermal cycling and vibration.

With recommended installation and torquing procedures, Durlon® 9000 Step Ring Gaskets normally do not need to be re-torqued, and will not

'cold flow' into the pipe ID or outside the flange OD. Tests have shown that Durlon® 9000 Step Ring Gaskets can retain up to 7% more load than traditional Fawn* PTFE Step Ring Gaskets which translates into a tighter seal, over a longer period of time.

**Traditional Fawn PTFE Step Ring Gasket design requires two different sized 1.5mm (1/16") thick ring gaskets to be bonded together with some form of industrial strength adhesive. Over time the adhesive breaks down due to thermal and chemical exposure.*

APPLICATIONS:

- Class 150 RF Floating (Lap Joint) Flanges
- Mondi™ Ductile Iron Sulfuric Acid Piping

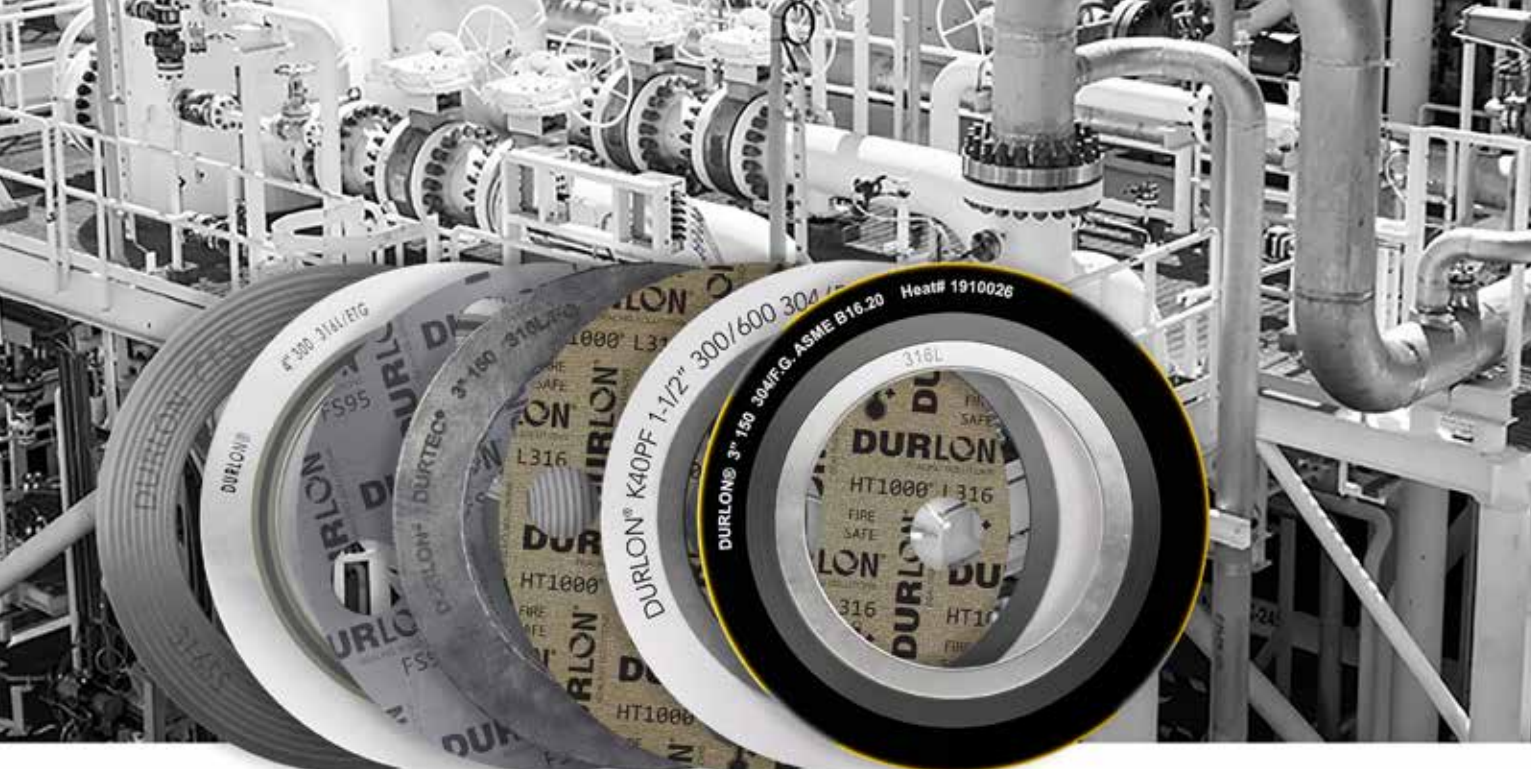

Metallic & Semi-Metallic Gasketing

Durlon® metallic gaskets are manufactured from a combination of metals and designed to withstand extreme temperatures, pressures and chemical exposure. Available in standard and custom configurations, these rugged metal gaskets are made of a wide range of materials to accommodate all types of process applications.

These gaskets are designed to work by "initial line contact" or a wedging action between the flange and the gasket.

Durlon® semi-metallic gaskets include both metallic and non-metallic components, either containing a metal core with sealing materials on both flat surfaces, or a pliable core encased in a thin metallic casing. These configurations are most popular, and available in a wide variety of styles and sizes. They can typically be fabricated of any metal which is available in thin strip or sheet, and that can be welded. Therefore, they can be used against virtually any corrosive medium dependent upon the choice of the metal and filler or facing material.

Our computer-aided manufacturing process uses rigorous quality control programs to ensure premium quality product performance. The metallic component gives the gasket superior structural integrity, while the non-metallic element ensures superior sealing. To be able

to achieve an effective seal, proper gasket selection must occur with metallic gaskets. The following elements must be considered when determining the correct gasket for the application.

TEMPERATURE

Most gaskets consist of two or more components or ingredients. The overall temperature resistance of a gasket is determined through analysis of the upper and lower limits for each component. There are two parts that need to be considered and verified when selecting the correct gasket material. The first part is to verify the metal component used to ensure the maximum temperature for the material is not exceeded. Secondly, the maximum temperature rating for the filler or facing material must be verified to ensure it is not exceeded. In most cases the filler or facing material will be the sacrificial element and will be the governing factor when selecting a semi-metallic gasket.

CHEMICAL COMPATIBILITY

The gasket must be resistant to chemical corrosion or chemical attack. The rate of corrosion is dependent on the time, temperature, and concentration of the media and must be considered when selecting both the gasket metallurgy and filler or facing material. For chemical resistance information of metals and semi-metallic gaskets, see pages 64-71.

FLANGE COMPATIBILITY

The flange itself must be designed so that it can apply a sufficient amount of clamping force to ensure the flange serrations are biting into, or seating the gasket. Flange materials also need to be verified against the specified metallurgy in semi-metallic gaskets. If left unverified, it is possible for galvanic type corrosion to occur due to dissimilar metals. In the use of RTJ gaskets, the gasket must deform enough to create an effective seal. If the material of the gasket is harder than the flange, it will damage the flange; hence the material hardness is critical when dealing with RTJ flanges and gaskets.

GASKET SEATING STRESS

The gasket seating stress is the minimum force required to compress the gasket so that it forms an effective seal while resisting the blowout or internal pressure of the system. Seating stress must also be taken into consideration with both the gasket type and flange surface finish. The minimum and maximum seating stresses are product specific and recommended by the manufacturer, the table below shows the recommended minimum and maximum stresses for Durlon® metallic gasketing products.

Gasket Type/Style	Minimum Gasket Stress (1,3)		Maximum Gasket Stress (3)	
	psi	bar	psi	bar
Graphite Sheet	1,000 - 2,000	68.95 - 137.90	10,000 - 24,000	689.5 - 1,655
Premium Machined-core Gasket (Durtec)	2,500 - 4,000	172.40 - 275.80	15,000 - 35,000	1,034 - 2,413
Kammprofile (Grooved Metal Gaskets with Covering Layers)	2,500 - 4,000	172.40 - 275.80	35,000 - 40,000	2,413 - 2,758
Corrugated Gaskets (CFG)	4,000 - 5,000	275.80 - 344.70	30,000	2,068
Low Stress Spiral Wound Gasket	5,800	379.20	30,000 - 35,000	2,068 - 2,413
Spiral Wound Gasket	7,500 - 10,000	517.10 - 689.50	30,000 - 40,000 (2)	2,068 - 2,758
*HT1000®	(5)	-	30,000	2,068
Ring Type Joint (RTJ)	(6)	-	35,000 - 40,000 (2)	2,413 - 2,758

*HT1000® is a registered trademark of Triangle Fluid Controls Ltd.

NOTES:

1. Minimum gasket stresses shown do not necessarily ensure any specific level of leak tightness. They generally reflect minimum seating stresses found in published documents. Specific manufacturer's data may fall outside of this range.
2. Maximum gasket stress shown may be dependent upon gasket materials used.
3. The gasket stresses shown above are not specific to any given leak tightness class (ie. T1, T2, T3, etc.)
4. Maximum gasket stress based on gasket diameter.
5. Contact tech@durlon.com with application specific details.
6. Minimum seating stress based on ring material selected.



DURLON® Durtec®

Specially Engineered Metal Core Technology

Durtec® is a registered trademark of Triangle Fluid Controls Ltd.

Durlon® Durtec® gaskets are made with a specially engineered machined metal core that is bonded on both sides with soft covering layers, typically flexible graphite. The core is produced by proprietary technology that allows the finished gasket to have the best possible mechanical support function. The Durtec® core is virtually uncrushable, unlike conventional corrugated metal core gaskets. The precision construction guarantees that Durlon® Durtec® gaskets will have excellent sealing characteristics even under low bolt loads.

The Durtec® gasket is designed to withstand high temperatures and pressures, to be blowout resistant, to be fire safe, and to resist toxic and or corrosive chemicals for such applications as: pipeline flanges, valves, small & large pressure vessels, heat exchangers, towers, and tanks.

INDUSTRY APPLICATIONS:

- Water & Wastewater
- Oil & Gas
- Mining
- Food & Beverage
- OEM Services
- Petrochemical
- Power Generation
- General Industrial
- Marine
- Chemical Processing
- Pulp & Paper

SIZE, TYPES & MATERIALS:

- Standard ASME, DIN, JIS and BS EN sizes
- Non-standard flanges 1/2" through 157" diameter
- Standard core material is 316L stainless steel. Other core materials: SS304, SS321, SS316Ti, Monel®, Titanium, Hastelloy® & Alloy 20 can be manufactured to your specifications on request
- Alternate facing material is available upon request. Popular materials include Durlon® 9600 expanded PTFE (ePTFE), mica & ceramic

HEAT EXCHANGER SHAPES

We can provide almost any configuration of heat exchanger type gasket utilizing our Durlon® Durtec® technology.

- Anywhere fire safety is a concern
- High temperature
- Low available assembly loads
- Heavy vibrations
- Extreme temperature fluctuations
- Remote field applications
- Large diameter gasket replacement

Physical Properties*	
Temperature:	
Min	-200°C (-328°F)
Max	1,000°C (1,832°F)
Continuous, Max	650°C (1,200°F)
pH range, Room Temp.	0-14
Pressure: Max, bar (psi)	430.9 (6,250)

*Depends on facing material and metallurgy of core.
Note: Data shown above is for Inconel® 625 core and HT1000® covering layers.

Certifications	
Fire Test**	API 607, 4th edition with Exxon modifications
RoHS Reach Declaration	Compliant

**Passed modified API 607 fire test and meets the requirements of Shell Specification MESG SPE 85/203 & PVRC SCR Flexible Graphite Spec for FG 600 material.

Gasket Factors	
G _b psi (MPa)	187 (1.29)
a	0.467
G _s psi (MPa)	0.5 (0.003)
m, Y psi (MPa)	1.5, 833 (5.74)

API 607 FIRE TEST:

- Average bolt torque loss (with no adjustments): Upstream 45%; Downstream 33%
- Fire, Cool-Down & Post-Burn: Combined Leak Rate (2 gaskets) 0 mL/min at 30 psig avg. where the allowable leakage rate is 150 mL/min.
- Exxon additional post burn leakage test: Combined Leak Rate (2 gaskets) with no flange bolt re-torques at any test pressure 0 mL/min at 30 psig, 0 mL/min at 50 psig, 0 mL/min at 100psig and, 0 mL/min at 200 psig where the allowable combined leakage rate is 150 mL/min.



DURLON® Flexible Graphite

Homogeneous, 316SS Foil Insert
316SS Tang Insert, 316SS Multilayer

Durlon® Flexible Graphite is unaffected by heat over a wide range of temperatures. It exhibits low electrical resistivity and high thermal conductivity and is suitable for cryogenic temperatures and is available in several styles.

These include homogeneous sheet and laminated styles with various types of core materials. Durlon® Flexible Graphite can also be special ordered with various inhibitors, grades of graphite, and core materials to suit specific critical applications.

INDUSTRY APPLICATIONS:

- Chemical Processing
- Petrochemical
- General Industry
- Power Generation
- OEM Services
- Refining
- Oil & Gas

CHARACTERISTICS AND BENEFITS:

- Impermeable to gases and liquids
- Maintains excellent sealability
- Suitable for service over a wide range of pressures and temperatures
- Does not age, shrink or harden
- Resists thermal shock
- Seals easily under low to moderate bolt loads
- High chemical resistant

FGS95 - Physical Properties	
Temperature: Min	-260°C (-450°F)
Max, in air	454°C (850°F)
Max, in steam	650°C (1,200°F)
Pressure, Max, bar	207 (3,000 psi)
Compressibility, % ASTM F36	35-40
Recovery, % ASTM F36	20
Creep Relaxation, % ASTM F36	5
Ignition Loss, % @ 454°C (850°F)	1
@ 650°C (1200°F)	8
Sealability, ASTM F2378	0.4 cc/min
ASTM F104 & F868 Line Call Outs	F104-F517000B1M3
Carbon Content	≥98%

Nominal Thickness*	Sheet Sizes	
	Inches	mm
1/32" (0.8mm)	39.4 x 39.4	1,000 x 1,000
	59.1 x 59.1	1,500 x 1,500
1/16" (1.5mm)	39.4 x 39.4	1,000 x 1,000
	59.1 x 59.1	1,500 x 1,500
1/8" (3.0mm)	39.4 x 39.4	1,000 x 1,000
	59.1 x 59.1	1,500 x 1,500

*More thicknesses available by special order, depending on material.

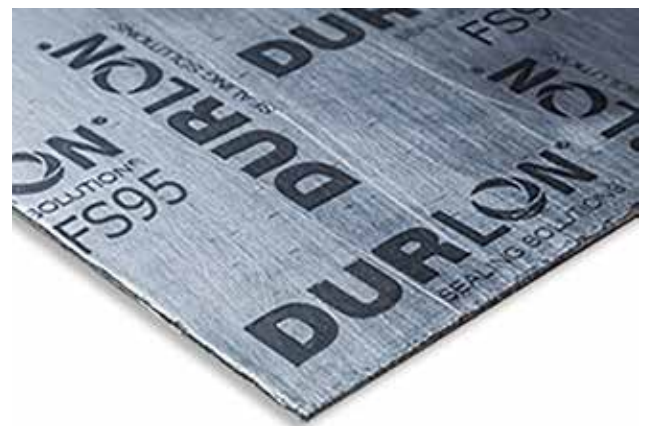

FGS95: Standard industrial grade sheet containing no binders or resins. Mainly used in industrial applications such as oil refineries, power plants and chemical process plants.

FGL316 - Physical Properties	
Temperature: Min	-260°C (-450°F)
Max, in air	454°C (850°F)
Max, in steam	650°C (1,200°F)
Pressure, Max, bar	207 (3,000 psi)
Compressibility, % ASTM F36	35-40
Recovery, % ASTM F36	18
Creep Relaxation, % ASTM F36	5
Ignition Loss, % @ 454°C (850°F)	1
@ 650°C (1200°F)	6
Sealability, ASTM F2378	0.4 cc/min
ASTM F104 & F868 Line Call Outs	F868-9FMF2
Carbon Content	≥98%



FGL316: Standard industrial grade sheet laminated with an adhesive bond on both sides of a 0.002” thick 316 stainless steel foil core. This product is used where high performance and handling are important.

FGT316 - Physical Properties	
Temperature: Min	-260°C (-450°F)
Max, in air	454°C (850°F)
Max, in steam	650°C (1,200°F)
Pressure, Max, bar	207 (3,000 psi)
Compressibility, % ASTM F36	35-40
Recovery, % ASTM F36	20
Creep Relaxation, % ASTM F36	5
Ignition Loss, % @ 454°C (850°F)	1
@ 650°C (1200°F)	6
Sealability, ASTM F2378	0.8 cc/min
ASTM F104 & F868 Line Call Outs	F868-9FMF1
Carbon Content	≥98%



FGT316: Standard industrial grade sheet mechanically bonded on both sides of a 0.004” thick 316 stainless steel tang core. This product is used where stresses and pressures are high and improved handling is important.

FGM316 - Physical Properties	
Temperature: Min	-260°C (-450°F)
Max, in air	550°C (1,022°F)
Max, in steam	650°C (1,200°F)
Pressure, Max, bar	250 (3,625 psi)
Compressibility, % ASTM F36	30-40
Recovery, % ASTM F36	10-15
Creep Relaxation, % ASTM F36	5
Ignition Loss, % @ 454°C (850°F)	<1
@ 650°C (1200°F)	<3
Sealability, ASTM F2378	0.4 cc/min
ASTM F104 & F868 Line Call Outs	F868-9FMF2
Carbon Content	≥98%



FGM316: Inhibited grade sheet laminated with multiple layers of 0.004” thick 316 stainless steel foil core. This product is used in applications with high mechanical stress or pressure, above average burst resistance, exceptional rigidity, and suitable to cut gaskets with narrow strips.

DURLON® HT1000®

Phlogopite Mica with Silicone Binder S90, L316, T316

HT1000® is a registered trademark of Triangle Fluid Controls Ltd.

Durlon® HT1000® consists of phlogopite mica paper impregnated with an inorganic binder at less than half the binder amount found in vermiculite-phyllsilicate filled products. This lower binder content allows for superior weight retention, less than 5% weight loss at 800°C (1,472°F), and results in ultimate extreme temperature sealing performance up to 1,000°C (1,832°F). Durlon® HT1000® characteristics allow for it to be used as a sealing material on its own or combined with various carrier media in heat exchangers, exhaust manifolds, and other equipment commonly found in the refinery, power generation, and chemical industries.

Phlogopite mica is a non-toxic naturally occurring hydrated silicate of potassium and magnesium with a lamellar and non-fibrous structure. It is flexible, has a high tensile strength, can withstand substantial mechanical pressure perpendicular to the lamellar plane, is chemically resistant, fireproof, infusible, incombustible, non-flammable, and is a known alternative to asbestos.

INDUSTRY APPLICATIONS:

- General Industry
- Marine
- Mining
- OEM Services
- Petrochemical
- Power Generation
- Refining

Certifications	
Fire Test	API 607, 4th edition with Exxon modifications
RoHS Reach Declaration	Compliant

Durlon® HT1000® sheets and cut gaskets are available in 3 sheet forms:

S90: Phlogopite mica paper impregnated with an inorganic binder and no carrier.

L316: Phlogopite mica paper impregnated with an inorganic binder laminated with a 0.002" thick 316 stainless steel carrier.

T316: Phlogopite mica paper impregnated with an inorganic binder laminated with a 0.004" thick 316 stainless steel perforated carrier.



S90



L316



T316

Physical Properties*	
Color	Metallic Green-Gold
Material	Phlogopite Mica, 90% min.
Binder	Silicone
Temperature: Min Max	-55°C (-67°F) 1,000°C (1,832°F)
Pressure, Max, bar (psi) Style S90 Styles L316/T316	5 (73) 40 (580)
Density, g/cc (lbs/ft³)	1.9 (119)
Compressibility, % ASTM F36J	18-25
Recovery, % ASTM F36J	39-43
Volume Resistance, (Ω/cm) IEC 60093 @ 23°C @ 500°C	~10 ¹⁵ ~10 ¹⁰
Weight Loss @ 800°C, % DIN 52911	≤5
Thermal Conductivity, W/(m.K) ASTM D5470-2017 @23°C @600°C	-0.20 -0.30
Dielectric Strength, (kV/mm) IEC 60243	~14
Flamability rating UL94	V-0

* The above table refers to Style S90 properties unless otherwise specified.



DURLON® HT1000® Paste

High Temperature Sealing Compound

HT1000® is a registered trademark of Triangle Fluid Controls Ltd.

Durlon® HT1000® Paste is a sealing compound designed to be used in conjunction with our HT1000® sheet material specifically for large dovetail gaskets. The paste allows end users to create larger diameter gaskets using cost effective dovetail gasket segments. The HT1000® Paste allows end users to eliminate possible leak paths of traditional dovetail gaskets, while providing end users the one piece gasket construction and lower leakage rates similar to one-piece gasket.

AVAILABILITY: 170 g (6 oz) and 90 g (3.2 oz) containers.

PASTE USAGE GUIDE:

HT1000® Paste is designed for use with HT1000® dovetailed gaskets.

Recommended Amount:

5 grams (0.18 oz) per inch of gasket cross-section per segment.

Example Calculation:

- Gasket Size: 60" ID x 66" OD (Cross-section: 3")
- Dovetails: 6 segments
- Paste Needed*: 5 g/in/segment × 3 in × 6 segments = 90 g (3.2 oz)

**Based on supplier input and internal experimentation.*

SHELF LIFE:

6 months in unopened container from the date it was packaged.

INSTRUCTIONS:

1. Make sure gasket segments are aligned and laying flat pre-assembled. Ensure that both the gasket and flange are free of debris, oils, and grease.
2. Open container of HT1000® Paste and apply a thin, even layer to the dovetail portion of the gasket, using a disposable brush or putty knife, smoothing out any uneven portions.
3. Assemble flange and tighten bolts according to gasket manufacturer's recommendations (torque, bolt-up method, etc.).
4. HT1000® Paste will begin to cure in service (Please see applicable Curing Time Chart to the right).

Physical Properties

Temperature:	
Min	260°C (500°F)
Max	1,000°C (1,832°F)

Curing Time Chart

Curing Temperature	Required Cure Time
149°C (300°F)	4 Hrs
204°C (400°F)	3 Hrs
260°C (500°F)	2 Hrs
316°C (600°F)	1 Hr
371°C (700°F) or Higher	<1 Hr

Note: In high pressure gasket sealing applications or if ambient pressure testing is being performed, it is recommended that the HT1000® Paste be pre-cured with a heat source such as a heat gun or oven if available prior to putting the gasket into pressurized service.

STORAGE: Store in closed container in a cool, dry place (refrigerate for best shelf life). Keep away from open flames.

WARRANTY: The company assumes no liability for damage caused by this product other than purchase or replacement of this product. The responsibility for determining whether or not the product is suitable for use rest with the purchaser.



DURLON® CFG

Corrugated Flexible Graphite Gasket

Durlon® CFG is a corrugated flexible graphite gasket material designed for severe service conditions. The proprietary design of the corrugations gives Durlon® CFG superior sealing and recovery characteristics for tough conditions in the refining, chemical, petrochemical, and pulp & paper industries. Durlon® CFG is suitable for service in steel, oil, mild alkalis, mild acids, hydrocarbons, and solvents.

Durlon® CFG consists of flexible graphite laminated with an adhesive bond on both sides of a corrugated 316 stainless steel core. For consolidation of inventories and applications standardization, Durlon® CFG is available for all applications in 3/32" (2.4mm) thickness. (1/16" and 1/8" thickness is also available.)

INDUSTRY APPLICATIONS:

- Water & Wastewater
- Oil & Gas
- Mining
- Food & Beverage
- OEM Services
- Petrochemical
- Power Generation
- General Industrial
- Marine
- Chemical Processing
- Pulp & Paper

Certifications	
Fire Test	API 6FB
RoHS Reach Declaration	Compliant

Physical Properties

Temperature:	
Min	-200°C (-328°F)
Max	650°C (1,200°F)
Continuous, Max	550°C (1,022°F)
pH range, Room Temp.	0-14
Pressure, Max, bar (psi)	207 (3,000)

Gasket Factors

G _b psi (MPa)	557 (3.84)
a	0.325
G _s psi (MPa)	2.21 (0.015)
m, Y psi (MPa)	2.6, 3770 (26.0)

ADVANTAGES:

- Recovery/Spring-Back characteristics for excellent sealing and thermal cycling
- Blowout Resistant - Metal core counteracts internal pressure spikes
- Superior Emissions Control - Nitrogen Sealability (ASTM F2378) <0.01 cc/min
- Easy to handle, easy to install
- Seals tightly with lower bolt loads vs. SWGs

MATERIALS:

- Alternate facing material is available upon request. Popular materials include Durlon® 9600 expanded PTFE (ePTFE), mica & ceramic



DURLON® ETG

Extreme Temperature Gaskets SWG/Durtec®/Kammprofile

The Durlon® ETG's design is the sealing industry's current best available technology for effectively sealing extreme temperature applications.

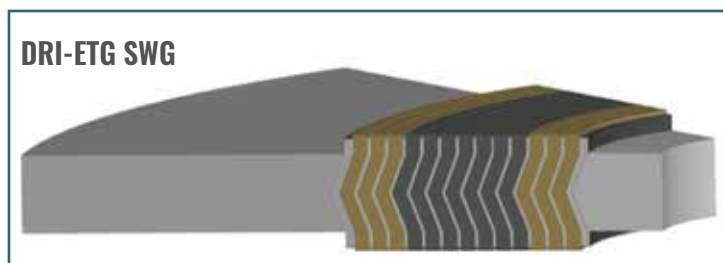

DRI-ETG SWG Certifications	
Fire Test	API 6FB, Fourth Edition 2019, Type 1 (Onshore Test)
Fire Test	API 6FB, Fourth Edition 2019, Type 2 (Offshore Test)
Fire Test	API 607, 4th Edition with Exxon Modifications

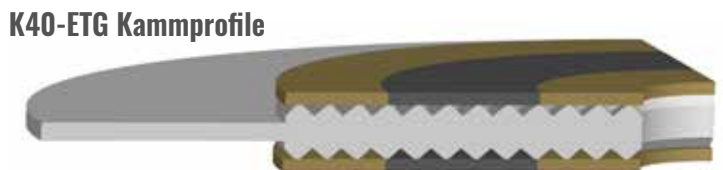
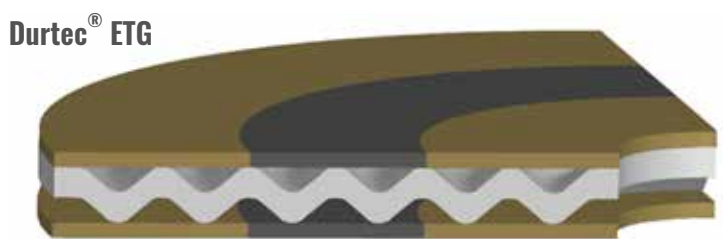

Durlon® Extreme Temperature Gaskets (ETG) have been engineered to provide the preeminent solution to sealing gasketed joints having exposure to high temperatures, typically greater than 650°C (1,200°F) and up to 1,000°C (1,832°F). At extreme temperatures, flange assembly torque retention is the key component to maintaining a tight seal. Durlon® ETG combines an oxidation boundary material with the excellent stability and sealing characteristics of flexible graphite in order to preserve seal integrity and retain the initial assembly torque.

Durlon® ETG's engineered design principle is focused around providing oxidation protection zones around the central oxidation inhibited flexible graphite sealing component. Standard industrial grade flexible graphite typically begins to rapidly oxidize at around 650°C (1,200°F). By adding oxidation inhibitors to the graphite, the rate and amount of oxidation can be significantly reduced, thus extending the seal life of the material. However, oxidation can still occur and at extreme temperatures, it can be fatal to the integrity of the joint.

Durlon® ETG adds an inner and outer protection boundary in the form of a mica-phyllsilicate based sealing material called Durlon® HT1000® which consists of phlogopite mica paper impregnated with an inorganic binder at less than half the binder amount found in a typical vermiculite-phyllsilicate filled product. This lower binder content allows for superior weight retention and results in ultimate extreme temperature sealing performance.

INDUSTRY APPLICATIONS:

- Mining
- Power Generation
- General/Heavy Industry
- Marine
- Refining
- Chemical Processing



DURLON® SWG

Spiral Wound Gaskets Style: D, DR & DRI ASME B16.20 Standards

Durlon® Spiral Wound Gaskets are made with an alternating combination of a preformed engineered metal strip and a more compressible filler material which creates an excellent seal when compressed. The engineered shape of the metal strip acts as a spring under load, resulting in a very resilient seal under varying conditions. The strip metallurgy and filler material can be selected to seal a wide range of applications. All Class 150 & 300 Durlon® SWG styles have been engineered to precise manufacturing tolerances and utilize optimal winding density that allow for lower stress (bolt load) sealing compared to conventional spiral wound gaskets thus eliminating the need to stock both standard and low stress SWG's.

All Durlon® SWG's are manufactured according to ASME B16.20 standards. Quality Assurance complies with API Specifications Q1 and ISO 9001 standards. Super Inhibited Graphite meets the requirements of Shell Specification MESC SPE 85/203 and meets PVRC SCR Flexible Graphite Spec for FG 600 material.

Durlon® SWG's obtain their initial seal with very low seating stresses and provide a tighter seal than typical low stress spiral wound gaskets and other high temperature alternative gaskets. Our advanced manufacturing process allows all Durlon® SWG's to perform better under low bolt stress applications while maintaining seal integrity under normal conditions.

INDUSTRY APPLICATIONS:

- Oil & Gas
- Petrochemical
- Chemical Processing
- Mining
- Power Generation
- Pulp & Paper
- Food & Beverage
- Heavy Industrial

Durlon® Style DR and DRI gasket centering rings (in carbon steel) are coated to inhibit atmospheric corrosion. Durlon® Spiral Wounds are packaged with the utmost care to prevent damage during shipping to the job site.

Gasket Factors	G _b psi (MPa)	a	G _s psi (MPa)
Type D, DR, DRI Graphite	86 (0.593)	0.594	0.1 (0.0001)
Type D, DR, DRI ETG	90 (.620)	0.590	0.1 (0.0001)
Type D, DR, DRI PTFE	173 (1.19)	0.405	1.0 (0.0007)

m & Y Factors	m	Y psi
Type D, DR, DRI Graphite, ETG & PTFE	2.8	5,800

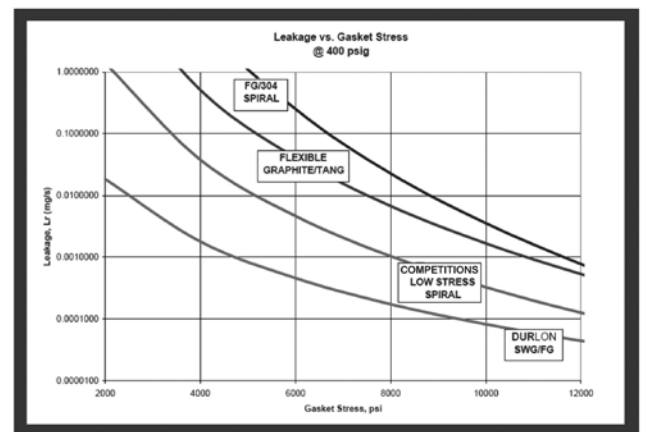

Certifications

Styles D, DR & DRI	TA Luft (VDI 2440)
6 inch Class 300 SWG FG	API Standard 6FB Fire Test

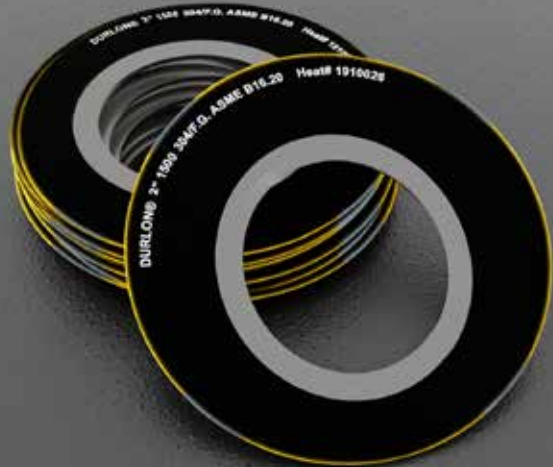

DURLON[®] SWG

Spiral Wound Gaskets Style: D, DR & DRI ASME B16.20 Standards

Style D

- Sealing element only consisting of preformed engineered metal and more compressible filler material
- Commonly used in tongue & groove or male & female flanges
- Can also be supplied with an inner ring as Style DI (Inner ring with winding and no center ring)



Style DR

- Sealing element (D) combined with a centering ring (R) which reinforces the gasket and acts as a compression stop
- Commonly used with standard Raised Face and Full Face type flanges
- Centering ring is epoxied which provides superior corrosion resistance compared to powder or liquid coating



Style DRI

- Sealing element (D) combined with a centering ring (R) and an inner ring (I) which improves radial strength and protects the sealing element from erosion and inward buckling
- Commonly used with standard Raised Face, Full Face type flanges and worn RTJ flange replacement gaskets
- Inner rings are recommended for all spiral wound gaskets but are mandatory (ASME B16 20-2007) for all PTFE filled gaskets, NPS (Nominal Pipe Size) 24" and larger Class 900, NPS 12", larger Class 1500 and NPS 4" and larger Class 2500



METALLURGY

Material	MIN		MAX		Code	GUIDE RING COLOR CODE
	°F	°C	°F	°C		
304 Stainless Steel	-320	-195	1,400	760	304	YELLOW
316L Stainless Steel	-320	-195	1,400	760	316L	GREEN
317L Stainless Steel	-320	-195	1,400	760	317L	MAROON
321 Stainless Steel	-320	-195	1,400	760	321	TURQUOISE
347 Stainless Steel	-320	-195	1,700	925	347	BLUE
Carbon Steel	-40	-40	1,000	540	CRS	SILVER
20Cb-3 (Alloy 20)	-300	-185	1,400	760	A-20	BLACK
HASTELLOY [®] B2	-300	-185	2,000	1,090	HAST B	BROWN
HASTELLOY [®] C 276	-300	-185	2,000	1,090	HAST C	BEIGE
INCOLOY [®] 800	-150	-100	1,600	870	IN 800	WHITE
INCOLOY [®] 825	-150	-100	1,600	870	IN 825	WHITE
INCONEL [®] 600	-150	-100	2,000	1,090	INC 600	GOLD
INCONEL [®] 625	-150	-100	2,000	1,090	INC 625	GOLD
INCONEL [®] X750	-150	-100	2,000	1,090	INX	NO COLOR
MONEL [®] 400	-200	-130	1,500	820	MON	ORANGE
Nickel 200	-320	-195	1,400	760	NI	RED
Titanium	-320	-195	2,000	1,090	TI	PURPLE

FILLER MATERIALS

Material	MIN		MAX		Code	STRIPE COLOR CODE
	°F	°C	°F	°C		
Ceramic	-350	-212	2,000	1,090	CER	LIGHT GREEN
Flexible Graphite	-350	-212	950	510	F.G.	GRAY
PTFE	-400	-240	500	260	PTFE	WHITE
Phyllosilicate	-67	-55	1,800	1,000	ETG	LIGHT BLUE

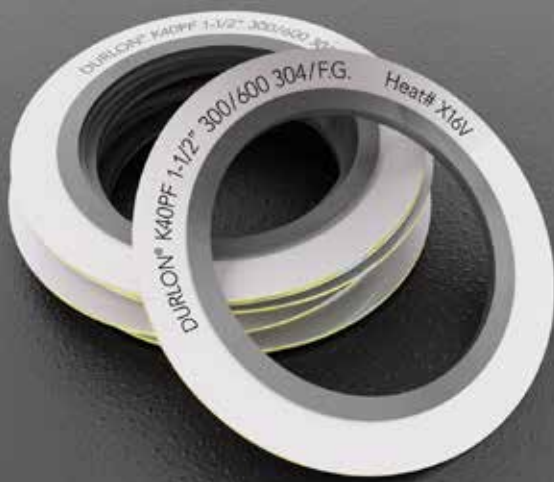

DURLON® Kammprofile

Serrated Flat Metal Gaskets
Grooved metal gasket with covering layers

Durlon® Kammprofile gaskets have a solid metal core with concentrically serrated grooves machined into the top and bottom faces. The metal core is typically stainless steel, but it can be supplied in various metallurgies as per the customer's request.

The serrated core is covered with soft sealing material and is dependent on the service conditions of the system. Flexible graphite and expanded PTFE sealing layers are most common, but other products like HT1000® or (Extreme Temperature Gaskets) ETG's can be used as well. While providing the Durlon® Kammprofile gasket with excellent sealing properties, the soft sealing layers also fill in minor flange imperfections and protect the flange surfaces from damage.

Durlon® Kammprofile gaskets are the preferred choice for applications requiring improved performance at low seating stresses. The serrated peaks provide reduced contact area and when combined with the soft conformable sealing layers, the Durlon® Kammprofile gasket provides a virtual metal-to-metal connection. They feature excellent resistance to blowout and provide superior stability for ease of handling and installation.

Durlon® Kammprofile gaskets are offered in 4 styles in each of the 2 core designs.

INDUSTRY APPLICATIONS:

- Oil & Gas
- Mining
- Petrochemical
- Power Generation
- Heavy Industrial
- Chemical Processing
- Pulp & Paper

Certifications	
RoHS Reach Declaration	Compliant

Gasket Factors	
m, Y psi (MPa)	4.00, 1,000 (6.70)

Physical Properties	
Temperature:	
Min	-200°C (-328°F)
Max (material dependent)	1,000°C (1,832°F)
Pressure, Max, bar (psi)	414 (6,000)
pH range, Room Temp.	0-14

CORE MATERIALS:

- Standard core material is 316 stainless steel with a nominal thickness of 0.125" (3mm)
- Other core materials and thicknesses are available to suit specific applications
- Core material is generally selected in an identical material to the piping system in order to reduce corrosion problems

FACING MATERIALS:

- Standard facing material is flexible graphite with a nominal thickness of 0.020" (0.5mm)
- Other facing materials and thicknesses are available to suit specific applications
- Meets Shell Specification MESC SPE 85/203 & PVRC SCR Flexible Graphite Spec for FG 600 material

SHAPES:

- Round, ovals (normal or irregular), manways, track shapes, diamonds, squares/rectangles, with ribs, etc.

FLANGE SURFACE FINISH:

- The ideal flange surface finish for use with Kammprofile gaskets is 125-250

CORE DESIGNS

K40P - Parallel Root Core

This core design is where the main sealing faces of the serrated metal core are parallel to each other.

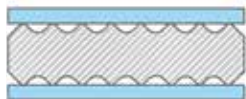

K40C - Convex Root Core

This core design is where the main sealing faces of the serrated metal core are slightly convex in profile. The convex core helps compensate when flange rotation is experienced on the bolt.



CUSTOM FABRICATED METALLIC GASKETS

We custom manufacture Durlon® Kamprofile gaskets to customer dimensional and material requirements. These gasket styles can be manufactured with common pass bar styles, typically used in heat exchangers up to 2,642mm (104”) in diameter. Using sophisticated semi-automatic digital equipment, we can ensure that dimensional stability and assembly precision are met on every gasket produced.

Combined with full internal traceability on raw materials, we provide custom fabricated metallic gaskets that can be depended on for the entire lifespan of the installation.



KAMMPROFILE/DURTEC GASKETS

- Size range 1/2” – 157”
- Parallel and convex cores
- Floating and integral CR's
- SWG Centering Rings
- SWG Inner Rings

AVAILABLE STYLES

K40PEF & K40CEF - Extended Core Floating, Centering Ring

Similar to the floating centering ring, this style has an extended core whereby providing additional strength and stability to the overall floating design.



K40PF & K40CF - Floating Centering Ring

A loose fitting centering ring is recommended on applications where thermal or pressure cycling can affect the integrity of the serrated metal core. It allows for expansion and contraction of the core through these cycling conditions.

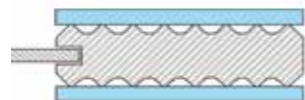

K40P & K40C - No Centering Ring

This basic configuration is most often used in tongue & groove and male & female flanges.

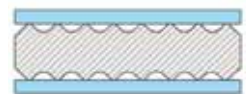

K40PI & K40CI - Integral Centering Ring

The centering ring is used to position the gasket between flat face and raised face type flanges.





Durlon® RTJ gaskets are precision machined from solid metal and are designed for high pressure and high temperature services. They seal by creating very high unit load, metal-to-metal line contact, with special mating flanges. Metals are typically chosen so that the ring gasket is softer than the flange material in order to prevent damage to the flanges and thereby causing plastic flow of the gasket into the flange faces.

The design of the gasket or cross-section is chosen based on the existing flange configuration and designed maximum system pressure. Gasket and flange surface finishes and dimensional accuracy along with gasket hardness must be carefully controlled in order to obtain and maintain an effective seal.

INDUSTRY APPLICATIONS:

- Mining
- Power Generation
- Oil & Gas
- Petrochemical
- General/Heavy Industry
- Marine
- OEM Services

Durlon® RTJ Characteristics

- All gaskets are completely identified with low-stress permanent markings indicating style, ring number, material and applicable standards
- All gaskets fully comply with the ASME B16.20 standard and the API spec 6A (where applicable)
- All materials are fully traceable and documentation can be supplied upon request or viewed via MetalTrace® on-line: www.trianglefluid.com/metal-trace/
- Material hardness is carefully controlled which ensures a good seal without damaging the surfaces of the flanges
- RTJ gaskets can withstand aggressive chemicals and temperatures up to 1,000°C (1,832°F) with properly selected metal
- All gaskets have a thin protective coating to eliminate oxidation effects due to atmospheric contact

DURLON® RTJ

Ring Type Joint Gaskets Styles: R, RX, BX

Style R

- Available in oval and octagonal cross-sections
- Style R gaskets are interchangeable on modern octagonal flat bottom grooved flanges
- Standard sizes of Style R gaskets are manufactured in accordance with ASME B16.20 and API 6A specifications

Style R - Octagonal



Style R - Oval



Style RX

- Style RX has a unique self-sealing action. The outside bevels of the ring make the initial contact, thus providing a seal against the groove's outer surfaces. As the internal pressure increases, so does the gasket loading stress against the groove, thus improving the gaskets sealing characteristics
- Design features of the Style RX make it more resistant to shock load, test pressure shock and drilling vibration
- Style RX ring joints are completely interchangeable* with standard Style R groove designs.

** Care should be taken when interchanging these styles as RX gaskets are taller and will add length to the finished assembly.*



Style BX

- Style BX features a pitch diameter slightly larger than the groove pitch diameter. This allows for initial contact to be made on the outside of the ring, creating a pressure energized seal
- All Style BX gaskets incorporate a pressure passage to enable trapped pressure to balance itself in the joint
- Style BX ring joint gaskets can only be used with API BX flanges and are not interchangeable with Style RX





DURLON® iGuard™

Isolation & Sealing Kits Styles: Type F, Type E, and Type D

Considering the environmental climate of today, it is more important than ever to prevent leakage in your piping systems. With flanges being the most common trouble area, proper sealing is key to preventing leakage. Durlon® offers quality products and materials which can help solve most flange sealing problems from eliminating leakage to preventing corrosion, and saving the integrity of the pipeline.

Our Durlon® iGuard™ flange Isolation & Sealing Kits are designed to be used on flanges and piping systems to create a dielectric break, which provides cathodic protection, assist in the prevention of corrosion and eventual break down of the metal, and isolate any current in the piping system from continuing down the line.

Gasket styles are available in Type F (Raised Face), Type E (Full Face) and Type D (RTJ) flanges from NPS ½” (DN15) to NPS 144” (DN 3600) or equivalent, to meet all international piping sizes. iGuard™ gaskets meet AWWA, ANSI, API, DN, JIS and all other dimensional standards.

GENERAL FEATURES

- Auto-Energizing double-ogee seal
- Low torque requirements
- Tri-directional seal movement for a tighter seal

INDUSTRY APPLICATIONS:

- Oil & Gas
- Marine
- Petrochemical
- Water/Wastewater
- Chemical Processing
- Mining
- Food & Beverage
- Pulp & Paper

PACKAGING

Each Durlon® iGuard™ Flange Isolation & Sealing Kit is packaged individually in durable corrugated boxes. Isolating sleeves and washers are packaged separately and cushioned within the box to protect them from damage during shipment. Each set is clearly tagged with flange size, pressure rating, type or isolating sleeve and whether it is a single washer or double washer set.

Type F (Raised Face Gasket)

The outside of the gasket fits inside of the flange bolt circle to ensure an exact positioning of the gasket.

Type E (Full Face Gasket)

This design facilitates proper alignment of the gasket during installation and prevents foreign material from shorting the flange isolation.

Type D (RTJ Gasket)

This design specifically fits into the ring groove of ring-type-joint flanges.

The Standard Kit

Consists of a gasket, isolating washers and isolating bolt/stud sleeves. The gasket carrier can be constructed of plain phenolic, neo-faced phenolic, epoxy glass (G-3, G-10 or G-11), epoxy glass (G-10) bonded to 316SS core, Durlon® 7910, 8400, 8500 or 9000.

Carrier	Sealing Element			
	Nitrile	EPDM	Viton	PTFE
Plain Phenolic	✓	✓	✓	✓
Neo-Faced Phenolic G-3	✓	✓	✓	✓
Silicone Glass G-7	✓	✓	✓	✓
Epoxy Glass G-10	✓	✓	✓	✓
Epoxy Glass G-11	✓	✓	✓	✓
Durlon® 7910	✗	✗	✗	✗
Durlon® 8400	✗	✗	✗	✗
Durlon® 8500	✗	✗	✗	✗
Durlon® 9000	✗	✗	✗	✗



Gaskets Durlon® 7910, 8400, 8500, 9000, EN, CS, HC

iGuard™ 7910

The iGuard™ 7910 quality commercial grade compressed sheet gasket material is manufactured from aramid/inorganic fiber material. Maximum pressure class - 300# ANSI.

iGuard™ 8400

The iGuard™ 8400 style isolation gasket is manufactured from phenolic fiber material to improve sealability in critical service chemical environments from pH 2-13 and other aggressive media to 290°C (554°F). Maximum pressure class - 300# ANSI.

iGuard™ 8500

The iGuard™ 8500 style isolation gasket is manufactured from aramid fiber material to improve sealability in steam environments to 287°C (548°F). Maximum pressure class - 300# ANSI.

iGuard™ 7910, 8400 & 8500 These kits come standard with one 3mm (1/8") thick genuine iGuard™ gasket, two isolating Nema grade G-10 washers, two SAE zinc plated steel backup washers, and one Nema grade G-10 sleeve tube for every bolt/stud. Maximum pressure class - 300# ANSI. These designs are ideal for ANSI Class 150 and 300 and come in sizes from NPS 1/2" (DN 25) to NPS 96" (DN 2400) or international equivalents in Type E (Full Face) or Type F (Raised Face) configurations.

iGuard™ 9000

The iGuard™ 9000 style isolation gasket is manufactured from 3mm (1/8") thick genuine Durlon® 9000 glass filled PTFE gasket material to improve sealability in critical service chemical environments from pH 0-14 and other aggressive media to 260°C(500°F). This design makes the iGuard™ 9000 ideal for cryogenic, petrochemical, pharmaceutical, semiconductor manufacturing, and food and beverage manufacturing applications in ANSI Class 150 and 300 or international equivalents. Sizes available: from NPS 1/2" (DN 25) to NPS 144" (DN 3600) in Type E (Full Face) or Type F (Raised Face) configurations. This kit comes standard with one iGuard™ 9000 gasket, two isolating PTFE washers, two SAE zinc plated steel backup washers, and one PTFE sleeve tube for every bolt/stud. Maximum pressure class - 300# ANSI.



Isolating Sleeves & Washers

iGuard™ EN

The iGuard™ EN style isolation gasket is manufactured from Nema grade G-10/FR-4 glass epoxy material incorporating a Viton double-ogee sealing element. This kit comes standard with one iGuard™ EN gasket, two isolating Nema grade G-10 washers, two SAE Zinc plated backup washer, and one Nema grade G-10 sleeve tube for every bolt/stud. Maximum pressure class - 2,500# ANSI, 10,000# API.

iGuard™ CS

The iGuard™ CS style isolation gasket is manufactured from 3mm (1/8") thick Nema grade G-10 glass epoxy material bonded to a 316 stainless steel internal core with a spring energized PTFE sealing element to prevent cold flow in critical service applications under continuous reciprocation movement or internal pressure surges at elevated temperatures. This design makes the iGuard™ CS ideal for API Class 15,000 and ANSI Class 600, 900, and 2,500 flange applications. This kit comes standard with one iGuard™ CS gasket, two isolating Nema grade G-10 washers, two SAE zinc plated steel backup washers, and one Nema grade G-10 sleeve tube for every bolt/stud. Maximum pressure class - 2,500# ANSI, 15,000# API.

iGuard™ HC

The iGuard™ HC style isolation gasket is manufactured from special high-compression 6mm (1/4") thick Nema grade G-10 glass epoxy material incorporating a spring energized PTFE sealing element to prevent cold flow under high pressures. This kit comes standard with one iGuard™ HC gasket, two isolating Nema grade G-10 washers, two SAE zinc plated steel backup washers, and one Nema grade G-10 sleeve tube for every bolt/stud. Maximum pressure class - 2,500# ANSI, 10,000# API.

In gaskets with phenolic or glass carrier rings, the double-ogee sealing element provides a reliable concentrated unit load on the flanges, using the lowest torquing conditions possible. For other styles, a spring energized PTFE sealing element is used.

iGuard™ Material Physical Properties

ASTM Test Method	Properties	D7910	D8400	D8500	D9000	Mylar*	Plain Phenolic	Nitrile Phenolic	Virgin PTFE	Hi-Temp. Phenolic G-3	Silicone Glass G-7	Epoxy Glass G-10	Epoxy Glass G-11	Critical Service CS
D149	Dielectric Strength, volts/Mil	279	371	297	406	400	500	500	285	550	350-400	550	550	488
D695	Compressive Strength psi	-	-	-	-	-	25,000	25,000	3,500	50,000	40,000	50,000	50,000+	80,000
D229	Water Absorption %	-	-	-	-	-	1.60	1.60	<.01	0.70	0.07	0.10	0.10	0.08
D257	Insulation Resistance, MegOhms	-	3.1 x 10 ⁷	4.2 x 10 ⁷	0.1	-	40,000	40,000	>10 ¹⁸	46,000	2,500	200,000	200,000	200,000
D790	Flexural Strength, psi	-	-	-	-	-	22,500	22,500	72,000	60,000	27,000	60,000	75,000+	77,000
D256	IZOD Impact Strength, Ft-Lbs/in.	-	-	-	-	-	1.2	1.2	3.5	12	8	14	12	9.1
D229	Operating Temp. °F	-100 to 500	-100 to 554	-100 to 548	-350 to 500	100 to 490	-65 to 250	-65 to 175	-350 to 500	-200 to 340	-200 to 430	Cryogenic to 284	Cryogenic to 356	Cryogenic to 500
	Operating Temp. °C	-73 to 260	-73 to 290	-73 to 287	-212 to 260	-75 to 255	-54 to 104	-54 to 79	-212 to 260	-129 to 171	-129 to 221	Cryogenic to 140	Cryogenic to 180	Cryogenic to 260

Mylar: The Isolation Sleeve is designed to fit over the bolt diameter & through the flange bolt holes inner diameter. The sleeve extends through both flanges & centers on the isolation washer thickness. Isolation Sleeves have a standard wall thickness of .03125" (.79mm), diameter & length of the isolation sleeve is determined by each application.

iGuard™ Installation Procedures

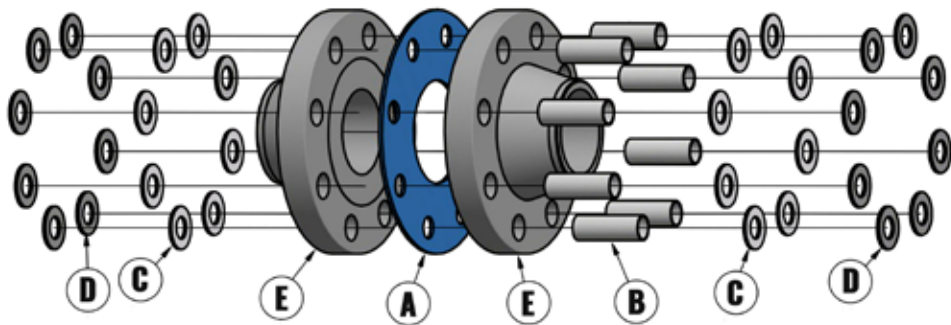

Parts List		
Description	Item	Qty
Durlon® Gasket	A	1
PTFE Sleeves	B	8
Washers	C	16
316SS Washers	D	16
Flange	E	2

BEFORE TIGHTENING

The flange faces make contact with the sealing elements which sit slightly higher than the isolating carrier ring.

AFTER TIGHTENING

The sealing element is compressed and moves bilaterally through the gasket radius thus filling the small gaps on either side of the sealing element. This radial movement provides a tighter seal with less stress on the carrier ring as compared to rectangular sealing elements used in other gasket styles in the market. The tri-directional movement of the sealing element provides better elastic recovery over time as bolt loads relax and pressure or temperature cycles occur.



Star Pattern Diagram

NOTE: Flanges are not included in the kit. Contact our Technical Department for more information about Installation, Bolt Torquing, the Star Patterns, and Load Values: tech@durlon.com

iGuard™ Recommended Application Chart

Service	Gasket	Seal	Sleeve	Washer	Temperature		Service	Gasket	Seal	Sleeve	Washer	Temperature	
					Low °C(°F)	High °C(°F)						Low °C(°F)	High °C(°F)
Acetone	Phenolic	EPDM	Mylar	Phenolic	0 (32)	27 (80)	Pentane	G10	PTFE	G10	G10	-184 (-300)	138 (280)
Air	G10	Nitrile	Mylar	Phenolic	-40 (-40)	107 (225)	Propane	G10	PTFE	G10	G10	-184 (-300)	138 (280)
Ammonia	G10	PTFE	Mylar	G10	-54 (-65)	104 (220)	Propylene	G10	Viton	G10	G10	0 (32)	27 (80)
Bleach	G10	PTFE	Mylar	G10	0 (32)	27 (100)	Sewage	G10	Viton	Mylar	G10	-29 (-20)	138 (280)
Carbon Dioxide	G10	Nitrile	Mylar	G10	0 (32)	38 (100)	Steam	-	-	-	-	-	-
Caustic Soda	ePTFE	-	ePTFE	ePTFE	-	-	Styrene	G10	PTFE	G10	G10	-184 (-300)	138 (280)
Cryogenic	G10	PTFE	G10	G10	-184 (-300)	138 (280)	Sulfur (Molten)	G10	PTFE	G10	G10	-184 (-300)	138 (280)
Ethanol	G10	EPDM	Mylar	G10	0 (32)	38 (100)	Tolulene	G10	Viton	G10	G10	0 (32)	66 (150)
Ethylene	G10	PTFE	G10	G10	0 (32)	27 (80)	Tolulene	Phenolic	Viton	Mylar	Phenolic	-40 (-40)	104 (220)
Fuel Oil	G10	Viton	Mylar	G10	-29 (-20)	138 (280)	Water, HOT	G10	EPDM	Mylar	G10	79 (175)	138 (280)
Jet Fuel	G10	Viton	Mylar	G10	-29 (-20)	107 (225)	Water, Potable	G10	EPDM	Mylar	Phenolic	0 (32)	138 (280)
Natural Gas	Phenolic	Nitrile	Mylar	Phenolic	-40 (-40)	104 (220)	Water, Sea	G10	EPDM	Mylar	Phenolic	0 (32)	138 (280)
Sour Gas	G10	Viton	Mylar	Phenolic	-29 (-20)	104 (220)	Sulfuric Acid	ePTFE	-	ePTFE	ePTFE	-	-
Gasoline	G10	PTFE	Mylar	G10	-54 (-65)	107 (225)	Sulfuric Acid <10%	G10	PTFE	G10	G10	-184 (-300)	138 (280)
Unleaded Gasoline	Phenolic	Viton	Mylar	Phenolic	-40 (-40)	104 (220)	Nitric Acid	ePTFE	-	ePTFE	ePTFE	-	-
Unleaded Gasoline	G10	Viton	Mylar	Phenolic	-29 (-20)	138 (280)	Nitric Acid <5%	G10	PTFE	G10	G10	-184 (-300)	138 (280)
Hydrogen	G10	Nitrile	Mylar	G10	0 (32)	66 (150)	Citric Acid	ePTFE	-	ePTFE	ePTFE	-	-
Black Liquor	ePTFE	-	G10	G10	-	-	Hydrochloric Acid <10%	G10	PTFE	G10	G10	-184 (-300)	138 (280)
White Liquor	ePTFE	-	G10	G10	-	-	Hydrochloric Acid	ePTFE	-	ePTFE	ePTFE	-	-
Spent Liquor	ePTFE	-	G10	G10	-	-	Acetic Acid <10%	G10	PTFE	G10	G10	-184 (-300)	138 (280)
LNG	G11	PTFE	G10	G10	-184 (-300)	38 (100)	Phosphoric Acid <25%	G10	PTFE	G10	G10	-184 (-300)	138 (280)
Mercaptan	G10	PTFE	G10	G10	-184 (-300)	138 (280)	Potassium Hydroxide	G10	PTFE	G10	G10	-184 (-300)	138 (280)
Methanol	G10	PTFE	G10	G10	-184 (-300)	138 (280)	Ammonium Hydroxide	G10	PTFE	G10	G10	-184 (-300)	138 (280)
Methyl Tertiary Butyl Ether	G10	PTFE	G10	G10	-184 (-300)	138 (280)	Trichloroethylene	Phenolic	Viton	Mylar	Phenolic	-40 (-40)	104 (220)
Nitrogen	Phenolic	Nitrile	Mylar	Phenolic	-40 (-40)	104 (220)	Auto Transmission Fluid	G10	Viton	G10	G10	0 (32)	66 (150)
Crude Oil	G10	Viton	Mylar	G10	-29 (-20)	138 (280)	Auto Transmission Fluid	Phenolic	Viton	Mylar	Phenolic	-40 (-40)	104 (220)
Oxygen	ePTFE	-	G10	G10	-54 (-65)	121 (250)							

This information is a general guide for the selection of a suitable gasket material. The substances listed above are evaluated for their effect on gasket materials at ambient temperature -40°C (-40°F) to 38°C (100°F) unless stated otherwise. For unusual conditions of fluid concentration, internal pressures or temperature or applications not listed above, consult your local representative. This evaluation is based on laboratory or field tests or experience; however, no guarantee can be given as to the actual performance experienced by the end user.

Gasket Fundamentals

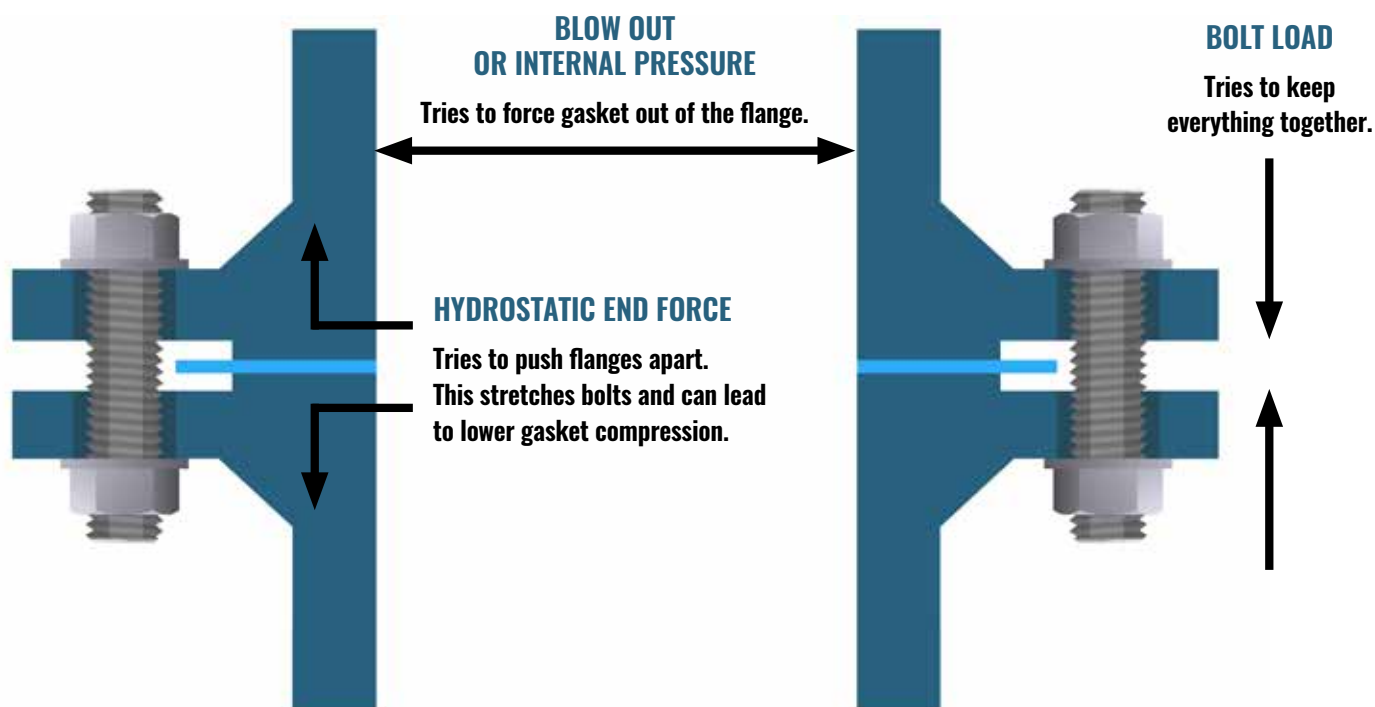

FORCES THAT OCCUR IN A GASKETED JOINT

The Function of a Gasket is to create and maintain a static seal between two stationary, imperfect surfaces of a mechanical system, designed to contain a wide variety of liquids or gases. The gasket must be able to maintain this seal under all the operating conditions of the system including extremes of temperature and pressure.

The performance of the gasket is affected by a number of factors. All of these factors must be taken into consideration when selecting a gasket.

Flange Load:

All gasket materials must have sufficient flange pressure to compress the gasket enough to insure that a tight, unbroken seal occurs.

The Internal Pressure:

In service, as soon as pressure is applied to the vessel, the initial gasket compression is reduced by the internal pressure acting against the gasket (blowout pressure) and the flanges (hydrostatic end force).

Temperature:

The effects of both ambient and process temperature on the gasket material, the flanges and the bolts must be taken into account. These effects include bolt elongation, creep relaxation of the gasket material or thermal degradation. This can result in a reduction of the flange load. The higher the operating temperature, the more care needs to be taken with the gasket material selection. As the system is pressurized and heated, the joint deforms. Different coefficients of expansion between the bolts, the flanges and the pipe can result in forces which can affect the gasket. The relative stiffness of the bolted joint determines whether there is a net gain or loss in the bolt load. Generally, flexible joints lose bolt load.

Fluid:

The media being sealed, usually a liquid or a gas, with a gas being harder to seal than a liquid. The effect of temperature on many fluids causes them to become more aggressive. Therefore, a fluid that can be sealed at ambient temperature may adversely affect the gasket at a higher temperature.

FLANGE FINISHES

It is common for pipe flange finishes to vary depending on the age and condition of the piping and the gasket material considered in the initial design. Concentric-serrated finishes are most commonly used in industry, with spiral-serrated (phonographic) finishes being less prevalent. The recommended flange finish depends on the type of gasket being used. The table (below right) illustrates the Durlon® recommended flange surface finishes by gasket type.

It is recommended that metal flange faces be machined with a concentric-serrated finish of 125-500 AARH, with 250 AARH being the optimum for non-metallic gaskets. Phonographic serrations can also be used with our materials. It should be recognized, however, that their continuous leak path makes them more difficult to seal.

“Smooth” finishes are usually found on machinery or flanged joints, rather than pipe flanges. When working with a smooth finish, it is important to consider using a thinner gasket to lessen the effects of creep and cold flow. It should be noted, however, that both a thinner gasket and the smooth finish, in and of themselves, require a higher compressive force (i.e. bolt torque) to achieve the seal.

FLANGE TYPES

The majority of flange materials used in industry are metallic and come in a variety of metallurgies, depending on the nature of the application’s pressure, temperature, and media requirements. Some applications require non-metallic flange materials, such as reinforced plastic, glass-lined steel, and glass. However, these materials are less robust and “softer” gasketing materials must be used.

Raised Face to Full Face: It is not recommended to mate a Full Face flange to a Raised Face flange, especially when the Full Face flange is cast or ductile iron. Due to the potential for warping the flange, or in the worst case cracking it, the utmost care should be taken.

Even if a spacer that fits on the Raised Face flange outside the Raised Face area is used, damage to the flanges can still occur and great care should be taken.





Full Face Flanges: In a bolted joint using ANSI Full Face (or flat face) flanges it must be remembered that the same bolts used in the corresponding Raised Face joint are now being asked to seal 3 to 4 times the gasket area with Full Face flanges. It is almost impossible to create an effective seal and high strength bolts should be considered.

ANSI Class 150 Full Face bolted joints are poor design and should only be used for non-critical fluids.

ANTI-SEIZE COMPOUNDS

The use of metal-based anti-seize compounds on the gasket or flange surface is not recommended due to the following issues: under heat and pressure, the metals in the compound can adhere to the flange surface, causing distortion of the flange and/or fill in the serrations. After a period of time, when this condition has been allowed to progress, no amount of additional torque will allow the gasket to seal. Applying anti-seize to the gasket lubricates the sealing surface. This isn’t a problem until gasket compression is lost for some reason. The lubricated gasket can either be extruded, attacked chemically, or forced out of the flange by the internal pressure. Here the friction created by the flange serrations play a role.

For these reasons the use of anti-seize is not recommended. The important thing is keeping the flange serrations intact, by making sure they are thoroughly cleaned each time a gasket is changed to maintain it’s integrity, to get good compression on the gasket, and a minimum bolt stress of at least 40% of bolt yield.

Gasket Description	Gasket Cross Section	Flange Surface Finish Micro-inch Ra.	Flange Surface Finish Micrometer Ra.
Metallic Serrated Gaskets		63 Max.	1.6 Max.
Spiral Wound Gaskets		125 - 250	3.2 - 6.3
Kammprofile Gaskets		125 - 250	3.2 - 6.3
CFG / Durtec		125 - 250	3.2 - 6.3

BOLTING

Bolted flange connections are only as good as the fastener system being used and unfortunately the fastener system is often overlooked within the design. The majority of fastener systems being used in the industrial world are threaded. The fastener system consists of at least the bolt/stud and the nut, but it is recommended to also include washers.

The application and distribution of torque can be improved through the use of washers under the head of the bolt and between the flange and nut. Washers effectively reduce the friction between the turning surfaces of the nut and bolt head to the flange, thus translating into a more accurate load being applied to the gasket. For standard applications it is recommended to use through-hardened washers, in order to prevent washer galling.

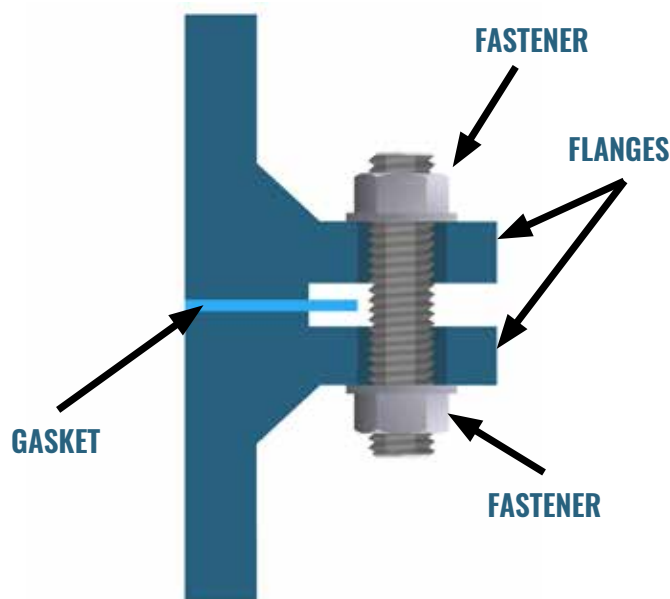

Bolting should be of sufficient strength to achieve proper compression of the gasket, to not only seal the joint, but to also maintain the seal without exceeding the yield strength of the bolts being used. The torque values in Durlon torque tables are based on using ASTM A193 Grade B7 studs and 2H heavy hex nuts lubricated with never seize.

Refer to the “Bolt Tightening Worksheet” (pg. 56) for more information on installation procedures.

GASKET SELECTION

With the emphasis on fugitive emissions gaining more and more prominence, selecting the proper gasket involves many considerations.

- Human safety
- Process safety
- Environmental concerns
- Life of service in the flange
- Maintenance costs
- Inventory costs

Other considerations when selecting a gasket are:

- Chemical compatibility with the process fluid
- The pressure-temperature (PxT Factor) relationship of the gasket to the service conditions
- Physical and mechanical properties of the gasket material
- Other considerations such as fire safety, and gasket design factors

MINIMIZING TORQUE LOSS

Proper gasket selection and installation should be based on minimizing torque loss. Torque loss can be caused by the tendency of the gasket to relax or remold after it has been compressed and/or by elongation of the bolts. This loss can be minimized several ways:

- 1. Use of a thinner gasket:** The surface of the gasket is actually the sealing surface. The internal portion of the gasket is used primarily to ensure that the imperfections in the sealing surface are filled. Since it is this internal portion that is primarily affected by creep relaxation, the thinner the gasket, the more effective the seal. However, if the surface to be sealed is pitted, marred or somewhat distorted, it may not be feasible to switch to a thinner gasket.
- 2. Use of a denser gasket:** In general, the denser the gasket material, the less creep relaxation will occur. With materials of similar composition, greater density will require greater seating stresses to seal. Therefore, some lighter flanges may not be strong enough to use with a denser material.
- 3. Use of a conical washer:** The elastic effect of a conical washer helps to compensate for some of the loss in gasket resilience. The washer also lengthens the bolt to a slight degree, lessening the effect of bolt elongation.
- 4. Greater bolt load:** The use of stronger bolts or more bolts can also help in the reduction of torque loss. Care should be taken to ensure that the maximum loads on the bolts are not exceeded.

CHEMICAL COMPATIBILITY

Chemical resistance of the gasket material is important because without it, the other properties of the gasket are irrelevant. It is also important to keep in mind the effect temperature has on chemical resistance.

The chemical resistance charts (pg. 64-71) can be a helpful guide. This information is available, but it must be remembered that most chemicals become more reactive at higher temperatures. This must always be considered when selecting the gasket.

In certain cases, it has been recommended to consider field testing within a controlled environment.

PRESSURE-TEMPERATURE (PXT FACTOR)

In all piping systems the flanges, valves, and the piping itself have a pressure – temperature relationship. This PxT factor is the result of multiplying the operating pressure times the operating temperature to arrive at a numerical value. This value is not constant and is different at each temperature and pressure combination. (Shown below is an example of the PxT factors for carbon steel piping per ANSI B16.34 and saturated steam).

PHYSICAL AND MECHANICAL PROPERTIES

ASTM F104, the Standard Classification System for Non-metallic Gasket Materials includes a line call-out encompassing ASTM test methods for evaluating the physical and mechanical properties of non-metallic gasket materials.

Some of these ASTM tests are:

- F 36 – Compressibility and Recovery
- F 2378 – Sealability
- F 38 – Creep relaxation

- F 146 – Fluid Resistance
- F1574 – Compressive Strength

In addition to ASTM tests, testing to BSI (British Standards), DIN (German Institute for Standardization) and FSA (Fluid Sealing Association) standards can be considered. These tests include:
 ASTM – F2837 – Hot Compression
 DIN – 3535 – Gas Permeability
 FSA – NMG-204 – High Pressure Saturated Steam Test

OTHER CONSIDERATIONS

Gasket design factors. The m and Y values established by ASME and the newer design factors being developed by the PVRC for fugitive emissions, are additional considerations. The m and Y values do not take fugitive emissions into account whereas the newer tightness parameters (Tp) do.

These gasket factors recognize that all joints leak to some extent. Therefore, an acceptable level of leakage is defined. A leak rate of 1/2480 lb/hr per inch of OD (0.002 mg/sec. mm) has been defined as a “standard” acceptable leak rate and is known as T2.

Tp classes and their associated leak rates are as follows:

- T1 – Economy – 1/25 lb/hr per inch of OD (0.2 mg/sec. mm)
- T2 – Standard – 1/2,480 lb/hr per inch of OD (0.002 mg/sec. mm)
- T3 – Tight – 1/248,000 lb/hr per inch of OD (0.00002 mg/sec. mm)

PRESSURE-TEMPERATURE RELATIONSHIPS						
Temp.	(Carbon Steel) Class 150		(Carbon Steel) Class 300		Saturated Steam	
°F	psi	(P x T)	psi	(P x T)	psi	(P x T)
100	285	(28,500)	740	(74,000)	1	(100)
200	260	(52,000)	675	(135,000)	12	(2,400)
300	230	(69,000)	655	(196,500)	68	(20,400)
400	200	(80,000)	635	(254,000)	250	(100,000)
500	170	(85,000)	600	(300,000)	680	(340,000)
600	140	(84,000)	550	(330,000)	1550	(930,000)
700	110	(77,000)	530	(374,500)	3100	(2,170,000)

Gasket Installation

CAUSES OF GASKET FAILURE

- Uneven loading of flanges holding gasket in place
- Gasket load too low
- Bolt strength too low
- Torque loss
- Bolt relaxation/strength (approximately 10% torque lost in first 24 hours)
- Gasket creep
- Vibration in the system
- Thermal cycling
- Water hammer
- Elastic interaction during bolt tightening
- Improper gasket installation practice

Reducing Gasket Failures

- Use proper gasket installation practices
- Lubricate bolts, washers and nut facings
- Bring the flanges together slowly and parallel (multiple passes with increasing torque, each pass following proper tightening sequence).
- Use a 1/16" thick gasket up to 8" flanges and 1/8" for 10" and above. (1/16" has less gasket creep)
- Be sure there is adequate gasket stress
- Periodic re-torquing
- Use the correct tightening pattern/method for the job:
Order of efficiency (least to greatest)
 - 1) Torque wrench
 - 2) Hydraulic torque wrench
 - 3) Hydraulic stud tension
- Installation procedures on the bolt tightening worksheet (pg. 56)
- Torque Values (pg. 60-63)

JOINT DISASSEMBLY WARNING

Prior to any joint disassembly, it is essential that plant procedures (lock-out and tag-out procedures) have been followed to depressurize and de-energize the system, including the removal of liquid head from the system, to ensure that the BFJA (Bolt Flange Joint Assembly) may be safely opened.

After reaffirming that all pressure on the joint has been released and the joint has been separated, proceed with bolt loosening and nut removal. Good general practice is to loosen the side of the joint away from yourself first to ensure in case of an accidental release that it is directed away from yourself. Disassembly of a BFJA should be conducted in a similar fashion as the initial assembly. Bolts should be loosened in increments and also in a crisscrossed pattern to ensure an even unload. The first loosening should be done at approximately 50% of the original recommended torque. Once joint separation is achieved, proceed with the balance of the bolt loosening and nut removal. An aid such as a hydraulic or manual flange spreader may be used if necessary to separate the joint.

Torque loss is inherent in any bolted joint. The combined effects of bolt relaxation, gasket creep, vibration in the system, thermal expansion, and elastic interaction during bolt tightening, contribute to torque loss. When torque loss reaches an extreme, the internal pressure exceeds the compressive force holding the gasket in place and a leak or blowout occurs.

A key to reducing these effects is proper gasket installation. Reduced maintenance costs and increased safety can be obtained by bringing the flanges together slowly and parallel when installing a new gasket, taking a minimum of four bolt tightening passes, and following the correct bolt tightening sequence/pattern.

Even when installation is ideal, the bolt stress is uniformly applied to each bolt, and the gasket is properly compressed, problems can still arise.

Inherently with time, loosening will occur due to gasket factors already mentioned. If other factors such as cycling, thermal upsets or vibration are present, periodic re-torquing might be necessary.



OVER-TIGHTENING - FLANGE ROTATION

The illustration below represents an over-tightening issue that can be observed on certain Class 150 flanges due to their lightweight nature. In the industry, the term “flange rotation” is used to describe this phenomenon, wherein the outer edges of the flange are “rotated” towards each other.

- Reduces the gasket contact area
- Crushes the gasket toward OD
- Allows fluid to penetrate gasket ID leading to deterioration of gasket
- Damages the flanges
- Result: leakage

In the case of Class 150 flanges, this occurrence arises due to their lightweight nature and insufficient thickness when subjected to high stress. Besides the potential damage to the flanges themselves, the over-tightening can result in gasket damage and potential leakage.

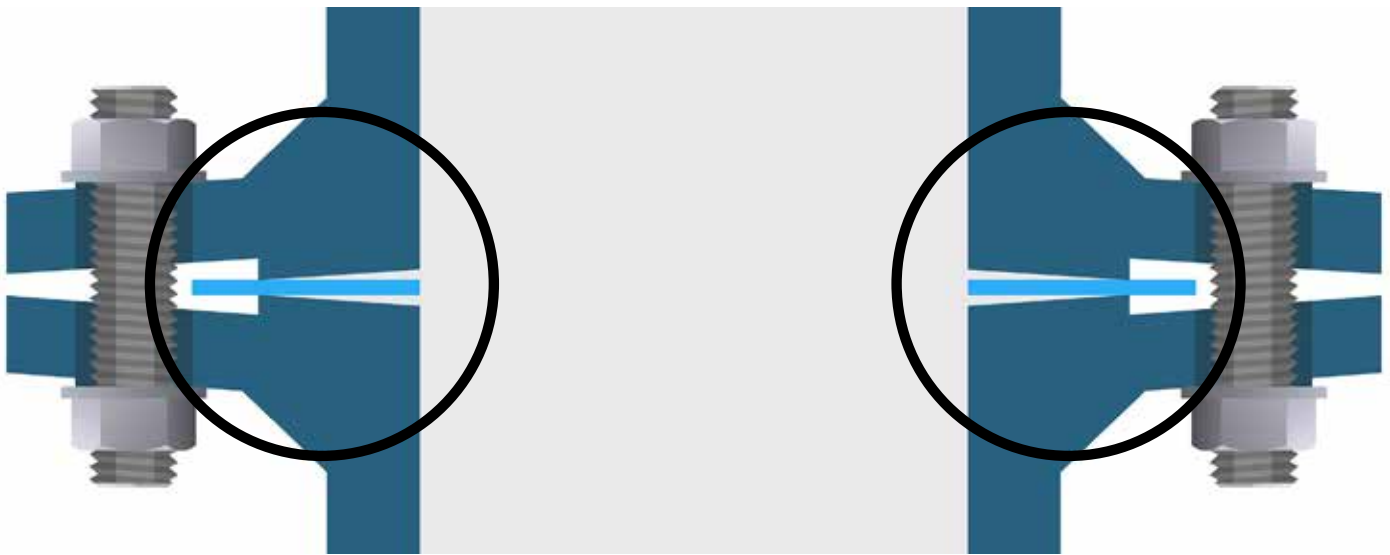

EFFECTS OF UNDER-TIGHTENING

The opposite of overloading is under-tightening, wherein an insufficient load is applied, resulting in the penetration of fluid and degradation of the gasket. It should be noted that all gaskets possess porosity and necessitate an adequate load to achieve a proper seal.

- Fluid is allowed to penetrate the gasket ID, leading to the deterioration of the gasket.
- Under-loading can lead to gasket blow-out or leakage.
- The unloading caused by temperature or pressure cycling can have an equivalent effect.

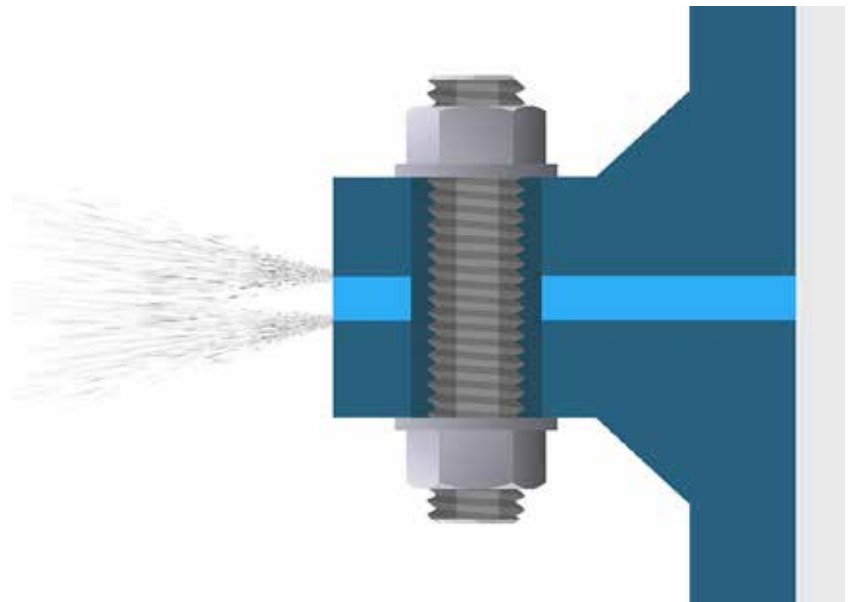

Gasket Installation Best Practices

The proper procedure for gasket installation involves meticulous attention to detail and adherence to best practices. Below is a step-by-step guide for gasket installation:



1 DEPRESSURIZE

Make sure system is at ambient temperature and depressurize



2 EXAMINE

Visually examine and clean flanges, bolts nuts and washers. Replace defective components if necessary.



3 LUBRICATE

Lubricate bolt threads, nut threads & facing, and washers.



4 INSTALL A NEW GASKET

Install a new gasket. Do not reuse old gaskets or multiple gaskets.



5 NUMBER BOLTS

Number bolts in a cross-pattern sequence according to this diagram. Pre-tightening: Hand tighten all nuts and if possible snug nuts with a hand wrench.



6 PRE-TIGHTEN

Use the appropriate cross pattern tightening sequence.



7 TORQUE IN SEQUENCE

ROUND 1	30%
ROUND 2	60%
ROUND 3	100%

Round 1; 30% of target torque.
Round 2; 60% of target torque.
Round 3; 100% of target torque.

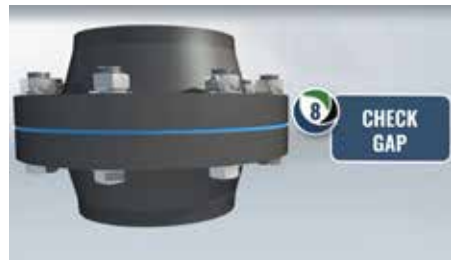

8 CHECK GAP

Check gap between each of these rounds, measured at every other bolt. If the gap is not reasonably uniform, make the appropriate adjustments by selective bolt tightening before proceeding.



9 ROTATIONAL ROUND

Use a rotational clockwise tightening sequence starting with bolt 1 for one complete round and continue until no further nut rotation occurs at 100% of the target torque value for any nut.



10 RE-TORQUE AFTER 4-24 HRS

Final-round is to re-torque after 4-24 hours at ambient temperature if possible. A large percentage of short-term preload loss occurs within 24 hours after initial tightening. Repeat rotational round to recover this loss. This re-torquing round covers this loss and is especially important for PTFE gaskets.

Note: If unsure about flange finish, defects, alignment or alternative tightening procedure, please refer to ASME PCC-1 Guideline for pressure boundary bolted flange joint assembly. For other specific applications or general procedures please contact the Durlon technical department at tech@durlon.com

Durlon® Bolt Tightening Worksheet

We recommend the completion of any installation assembly worksheet with the details, including the installer signature and date for verification. You can use the Durlon worksheet for easy adoption into your QC program.

Location/Identification: _____ Nominal Bolt Size: _____

Gasket Contact Surface Finish on Flange: _____ Lubricant Used: _____

(Initial each step as you progress through the list below.)

- _____ 1. Be sure system is at ambient temperature and depressurized. Follow local safety rules.
- _____ 2. Visually examine and clean flanges, bolts, nuts and washers. Replace components if necessary.
- _____ 3. Lubricate bolts, nuts, and nut bearing surfaces. Use of hardened steel washers are recommended.
- _____ 4. Install new gasket. **DO NOT REUSE OLD GASKET, OR MULTIPLE GASKETS.**
- _____ 5. Number bolts in cross-pattern sequence according to the appropriate illustrations below.
- _____ 6. **IMPORTANT! HAND TIGHTEN NUTS, then using a hand wrench, SNUG BOLTS 1/8 TO 1/4 turn, following the appropriate cross-pattern tightening sequence for the number of bolts below.**
- _____ 7. Starting at the #1 bolt, use the appropriate cross-pattern tightening sequence for Rounds 1, 2, and 3 (each sequence constitutes a "Round").

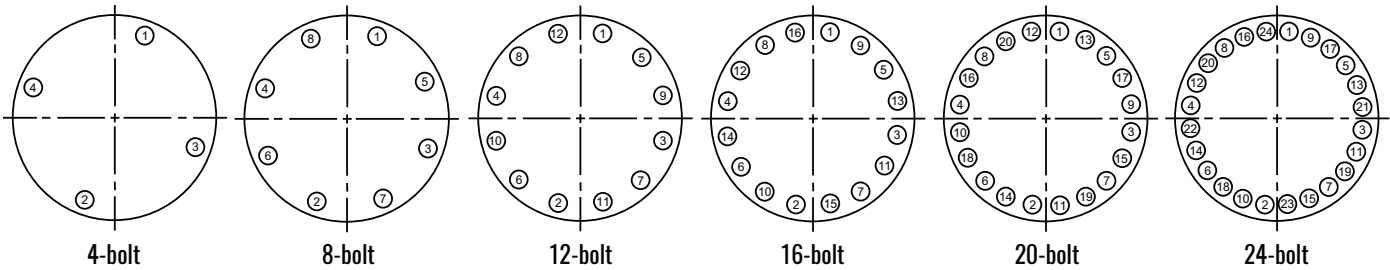

Final Torque: _____ Ft-lbs

LUBRICATE, HAND TIGHTEN, PRE-TIGHTEN BOLTS

- _____ **Round 1:** Tighten to _____ Ft-lbs - 1st torque value in torque chart (30% of final torque)
- _____ **Round 2:** Tighten to _____ Ft-lbs - 2nd torque value in torque chart (60% of final torque)
- _____ **Round 3:** Tighten to _____ Ft-lbs - Final torque value in torque chart (100% of final torque)

Check gap at 90° intervals around the flange between each of these rounds. Larger flanges may require checking the gap in smaller intervals. If the gap is not reasonably uniform, make the appropriate adjustments by selective bolt tightening before proceeding.

_____ **Rotational Round** - 100% of Final Torque (same as Round 3). Use rotational, clockwise tightening sequence, starting with Bolt No. 1, for at least two complete rounds and continue until no further nut rotation occurs at 100% of the Final Torque value for any nut.

_____ **Retorque** - Short-term bolt preload loss can occur between four to twenty-four hours after initial tightening due to bolt relaxation and/or gasket creep. Repeating the Rotational Sound recovers this loss. This is especially important for PTFE gaskets.

Joint Assembler: _____ Date: _____

For torque questions, or tightening patterns for large diameter flanges, contact tech@durlon.com

This page can be copied for use in the field



Gasket Installation Training

Durlon® offers bolt-up and gasket training utilizing a Flange Assembly Demonstration Unit (FADU) based on ASME PCC-1 principles. This 90 minute training incorporates live feedback on the screen as the gasket is simultaneously bolted into place. Participants observe gasket deflection, bolt stress and interaction between bolts (crosstalk), and learn the value of following PCC-1 guidelines and get the opportunity to put their experience to the test.



Our Gasket Rig is Completely Portable

CALL NOW to arrange set-up at your location. We can conveniently set at your location. From beginner to advanced training options. Let us custom fit your needs.*

Who Should Attend

- Pipe fitters
- Maintenance Personnel
- Gasket Fabricators
- Gasket Distributors
- Contractors
- Engineers
- Planners

Training Benefits

- Learn about bolted flange connections
- Increase gasket life
- Reduce maintenance costs
- Become proactive to fugitive emissions and the environment
- Increase plant pipeline safety and reliability

Agenda

- Scattered Bolt Load
- Bolt/Stud Tensile/Yield Strength
- Proper Lubrication
- Legacy/Cross Pattern Bolt-Up
- Use of Washers
- Body Positioning
- Torque/Box Wrenches
- Proper Arm Movement

Request Your Training Date!

Locations:
USA
Canada

E-mail and Web:
sales@gasketresources.com
info@trianglefluid.com

Phone numbers:
1-866-707-7300
1-866-537-1133

*Does not include Rig transportation and other administration costs - based on location and meeting minimum enrollment criteria.

Gasket Factors



Gasket factors are very important to understand but unfortunately can be difficult to understand or are easily misinterpreted. This section contains some of the more popular versions of Gasket Factors used in determining the recommended torque for gasket installation.

EN 13555

EN 13555 is a working standard, much like ASME PVRC gasket factors, in the EU. It provides the testing procedures to allow persons to derive the gasket parameters: Q_{smax} , $Q_{(min)L}$, $Q_{smin(L)}$, P_{QR} , and E_G so they can be used in design equations found in EN 1591-1 (Flanges and Their Joints - Design Rules for Gasketed Circular Flange Connections - Part 1: Calculation). For a further definition of the gasket parameters see chart (to right).

When the final torque values are calculated using the previous gasket parameters, leakage can be classified into three tightness classes:

Gasket Parameters	
Q_{smax}	Maximum seating stress required on the gasket at a given temperature without crushing the material.
$Q_{(min)L}$	Minimum seating stress that is required in assembly at ambient temperature to seat gasket into the flange serrations and seal internal leakage, based on tightness class, L, and specified test pressure.
$Q_{smin(L)}$	Minimum gasket seating stress required in service conditions after unloading gasket (at service temperature), so that the specified tightness class L, is maintained based on internal test pressure.
P_{QR}	This factor allows for the gasket's effect on the load applied and the relaxation of the gasket from start (final bolt-up) and after the extended life term of the material's intended service temperature.
E_G	This is the unloading moduli, which is derived from the recovery of the gasket thickness between the initial compression seating stress and unloading the gasket to 1/3 of its initial seating stress.

Tightness Class	Specific Leak Rates (mg/s-m)
$L_{1.0}$	1.0
$L_{0.1}$	0.1
$L_{0.01}$	0.01

m & Y

m and Y values are for flange design only and are not meant to be used as gasket seating stress values in actual service. “m” is known as the maintenance factor or the multiplier. The “Y” factor is the minimum stress required (psi) over the sealing area of the gasket to provide a seal at an internal pressure of 2 psig. “Y” is not considered to be the minimum seating stress for the gasket in service. These values are used in formulas in the ASME Boiler and Pressure Vessel Code, Division 1, Section VIII, Appendix 2, to give a WM1 (minimum required bolt load for operating conditions, psi) or WM2 (minimum required bolt load for gasket seating, psi) value, based on either gasket seating or the internal pressure. The flange is designed based on the greater of these two values (WM1 or WM2). This will ensure that the flange is robust enough to maintain adequate gasket seating stress, which can decline due to flange rotation with weaker flanges when bolted up and internal pressure is introduced. These values do not take fugitive emissions into account and therefore, based on leakage, newer gasket constants G_b , a , and G_s are being developed, based on leakage to take this into account.

Alternative ASME PVRC Gasket Factors: G_b , a and G_s

New gasket factors to replace the ASME Code m and Y are currently being developed by the Pressure Vessel Research Council (PVRC) and ASME. The current m and Y are difficult to replicate for non-asbestos gaskets and do not take joint leakage into

Tightness Type	Economy		Standard		High		Exceptional	
	T1	T1.5	T2	T2.5	T3	T3.5	T4	T4.5
Leak Rate (mg/s/mm)	2.0E-01	2.0E-02	2.0E-03	2.0E-04	2.0E-05	2.0E-06	2.0E-07	2.0E-08
Compressed Non-Asbestos & PTFE Materials	2.5:20 (2,900)			14.2:20 (2,900)	32.3:60 (8,700)	14.3:100 (14,500)	11.5:160 (23,200)	98.9:160 (23,200)
				7.9:40 (5,800)	7.9:80 (11,600)			
				2.7:60 (8,700)	2.4:100 (14,500)	1.7:160 (23,200)		
Graphite Filled Spiral Wound Gasket	8:20 (2,900)				7:80 (11,600)	4:160 (23,200)	8:120 (17,400)	-
	4:40 (5,800)				4:160 (23,200)			-
	2.5:60 (8,700)							-

Recommended Value	Possible Value	Not Recommended Value
-------------------	----------------	-----------------------

account. The new approach to bolted joint design makes the tightness of the joint a design parameter. In a manner similar to that of the traditional ASME Code method, the design bolt load for a joint is calculated for operating and seating requirements from the new constants G_b , a , and G_s , and the required tightness class associated with the minimum tightness.

“ G_b ” and “ a ” provide the gasket seating load; similar to Y in the present Code. “ G_s ” is associated with the operating stress and is similar to the m value in the present Code. The proposed ASME constants G_b , a , and G_s give a design bolt load, obtained by

interpretation of leakage test data as plots of gasket stress, S_g , versus a tightness parameter, T_p . T_p is the pressure (in atmospheres) normalized to the atmospheric pressure required to cause a helium leak rate of 1 mg/sec for a 150 mm OD gasket in a joint. Since this is about the same as the OD of an NPS 4 joint, the pressure to cause a leak of 1 mg/sec of helium for that joint is its tightness. A standard test procedure, the PVRC Room Temperature Tightness Test (ROTT), has been designed to produce the constants G_b , a , and G_s . Low values for G_b , a , and G_s are desirable while a higher value of T_p means a tighter joint.

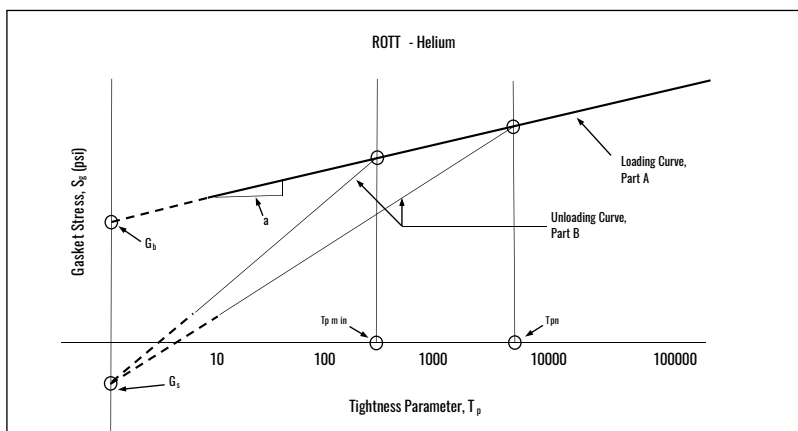

Tightness Class	Mass Leak Rate/Unit Diameter (L_{rm}) mg/sec-min (lb/hr per “ of OD)
T1	2×10^{-1} (0.04)
T2	2×10^{-3} (0.0004)
T3	2×10^{-5} (0.000004)
T4	2×10^{-7} (0.00000004)
T5	2×10^{-9} (0.0000000004)

Torque Values - Durlon® Sheet Gasket Material

Pipe Size	ASME B16.21 Ring Gasket, Ft-Lbs (N-M)					
	Fasteners: A193-B7 or B16 lubricated with a never seize type lubricant, k=0.17					
	Class 150			Class 300		
	Min. [1, 2]	Optimal [1, 3]	Max. [4, 5]	Min. [1, 2]	Optimal [1, 3]	Max. [4, 5]
1/2"	10 (14)	25 (33)	25 (33)	10 (14)	25 (34)	25 (34)
3/4"	15 (20)	30 (41)	35 (48)	15 (20)	45 (61)	45 (61)
1"	15 (20)	35 (48)	50 (68)	20 (27)	55 (75)	60 (81)
1 1/4"	25 (34)	45 (61)	75 (102)	35 (47)	80 (108)	90 (122)
1 1/2"	30 (41)	60 (82)	80 (109)	50 (68)	140 (190)	145 (197)
2"	65 (88)	120 (163)	160 (217)	35 (47)	80 (108)	100 (136)
2 1/2"	80 (108)	120 (163)	160 (217)	50 (68)	125 (169)	135 (183)
3"	115 (156)	150 (203)	160 (217)	75 (102)	180 (244)	200 (271)
3 1/2"	65 (88)	120 (163)	160 (217)	85 (115)	180 (244)	225 (305)
4"	80 (109)	120 (163)	160 (217)	105 (142)	215 (292)	285 (386)
5"	120 (163)	215 (292)	280 (380)	140 (190)	215 (292)	285 (386)
6"	155 (211)	230 (312)	285 (386)	120 (163)	195 (264)	285 (386)
8"	215 (291)	285 (386)	285 (386)	195 (264)	315 (427)	460 (624)
10"	210 (284)	345 (468)	460 (624)	215 (292)	385 (522)	490 (664)
12"	280 (380)	400 (542)	460 (624)	330 (447)	570 (773)	735 (997)
14"	355 (481)	515 (698)	685 (929)	295 (400)	570 (773)	640 (868)
16"	340 (461)	515 (698)	675 (915)	420 (569)	795 (1078)	900 (1220)
18"	500 (678)	755 (1024)	1010 (1369)	465 (630)	885 (1200)	1020 (1383)
20"	460 (624)	755 (1024)	1010 (1369)	530 (719)	885 (1200)	1120 (1519)
22"	610 (827)	1060 (1437)	1415 (1918)	760 (1030)	1425 (1932)	1600 (2169)
24"	670 (909)	1060 (1437)	1415 (1918)	850 (1152)	1425 (1932)	1740 (2359)

Disclaimer: This is a general guide only and TFC/GRI, does not accept responsibility for negligence or misuse of this information.

General Notes:

- a) Torque Values are in ft.-lbs. and assume new A193 Gr. B7 or B16 fasteners with 2H heavy hex nuts; with studs, nuts and the nut bearing surfaces lubricated with a never-seize type lubricant (k = 0.17).
- b) A193 Gr. B7 & B16 fasteners have the same yield strength up to 4" diameter. There are "no" fasteners above 4" diameter in this chart.
- c) All torque values are based on using a "calibrated" torque wrench.
- d) All torque values in the chart above are based on using the tensile area of the fastener.
- e) All torque values in chart are rounded to nearest 5 ft.-lbs.

Footnotes:

^[1] Torque values are based using ASME B16.5-2020 MAWP (Maximum Allowable Working Pressure) at ambient in the gasket stress calculation.

Min. Torque Values:

^[2] Min. torque values are based achieving 4,800 psi gasket stress without exceeding 80,000 psi bolt stress or PCC-1 2019 FEA SA105 Max. Stud Stress Before Flange Yielding.

Optimal Torque Values:

^[3] Optimal torque values are based on a target of 7,000 to 12,000 psi optimum gasket stress without exceeding 80,000 psi bolt stress or PCC-1 2019 FEA SA105 Max. Stud Stress Before Flange Yielding.

- Cases where torque equals ≤ 60,000 bolts stress
- Cases where torque equals > 60,000 ≤ 75,000 bolts stress
- Cases where torque equals > 75,000 ≤ 80,000 bolts stress

Max. Torque Values:

^[4] Max. torque values are based on; max allowable 15,000 psi gasket stress; PCC-1 2019 FEA SA105 Max. Stud Stress Before Flange Yielding, or 80,000 psi bolt stress, whichever occurs 1st. Note: In some cases the max. torque values may be equal to the optimal torque values in order to optimize gasket stress levels.

^[5] 1/2" through 1 1/2" NPS & 3 1/2" NPS due to "No Data" on flange yielding; Max. torque values are set to achieve max gasket stress of 15,000 or 80,000 psi bolt stress, whichever occurs 1st.

- Cases where torque is based on 80,000 bolts stress.
- Cases where torque is based on PCC-1 2019 FEA SA105 Max. Stud Stress Before Flange Yielding.
- Cases where torque is based on max. allowable 15,000 psi gasket stress.

Torque Values - Durlon® Spiral Wound Gaskets – Class 150 & 300

Pipe Size	ASME B16.20 SWG Gasket, Ft-Lbs (N-M)					
	Fasteners: A193-B7 or B16 lubricated with a never seize type lubricant, k = 0.17					
	Class 150			Class 300		
	Min. [1, 2]	Optimal [1, 3]	Max. [4, 5]	Min. [1, 2]	Optimal [1, 3]	Max. [4, 5]
½"	20 (27)	35 (47)	55 (75)	20 (27)	35 (47)	55 (75)
¾"	25 (34)	50 (68)	80 (109)	30 (41)	65 (88)	100 (136)
1"	35 (47)	70 (95)	80 (109)	45 (61)	90 (122)	135 (183)
1 ¼"	40 (54)	*75 (102)	80 (109)	50 (68)	100 (136)	150 (203)
1 ½"	55 (75)	*75 (102)	80 (109)	85 (115)	165 (224)	250 (339)
2"	90 (122)	*150 (203)	160 (217)	45 (61)	90 (122)	115 (156)
2 ½"	105 (142)	*150 (203)	160 (217)	65 (88)	125 (169)	170 (230)
3"	150 (203)	**150 (203)	160 (217)	100 (136)	185 (251)	225 (305)
3 ½"	85 (116)	*150 (203)	160 (217)	110 (149)	210 (285)	285 (386)
4"	110 (150)	*150 (203)	160 (217)	145 (197)	*265 (359)	285 (386)
5"	160 (218)	*265 (359)	280 (380)	180 (244)	*265 (359)	285 (386)
6"	230 (313)	**265 (359)	285 (386)	170 (230)	*265 (359)	285 (386)
8"	285 (386)	***285 (386)	285 (386)	285 (386)	*430 (583)	460 (624)
10"	315 (427)	*430 (583)	460 (624)	310 (420)	560 (759)	675 (915)
12"	430 (583)	**435 (590)	460 (624)	480 (651)	865 (1173)	990 (1342)
14"	545 (739)	*645 (875)	685 (929)	425 (576)	760 (1030)	795 (1078)
16"	545 (739)	**645 (875)	675 (915)	635 (861)	*1105 (1498)	1115 (1512)
18"	870 (1180)	**945 (1281)	1005 (1363)	740 (1003)	*1200 (1627)	1210 (1641)
20"	775 (1051)	*945 (1281)	1005 (1363)	830 (1125)	*1290 (1749)	1300 (1763)
22"	635 (861)	*930 (1261)	1415 (1918)	1050 (1424)	*1830 (2481)	2330 (3159)
24"	1135 (1539)	**1325 (1796)	1415 (1918)	1325 (1796)	*2150 (2915)	2165 (2935)

Disclaimer: This is a general guide only and TFC/GRI, does not accept responsibility for negligence or misuse of this information.

General Notes:

- a) Torque Values are in ft.-lbs. and assume new A193 Gr. B7 or B16 fasteners with 2H heavy hex nuts; with studs, nuts and the nut bearing surfaces lubricated with a never-seize type lubricant (k = 0.17).
- b) A193 Gr. B7 & B16 fasteners have the same yield strength up to 4" diameter. There are "no" fasteners above 4" diameter in this chart.
- c) All torque values are based on using a "calibrated" torque wrench.
- d) All torque values in the chart above are based on the use of an inner/outer ring style (DRI) spiral wound gasket.
- e) All torque values in the chart above are based on using the tensile area of the fastener.
- f) All torque values in chart are rounded to nearest 5 ft.-lbs.

Footnotes:

^[1] Torque values are based using ASME B16.5-2020 MAWP (Maximum Allowable Working Pressure) at ambient in the gasket stress calculation.

Min. Torque Values:

^[2] Min. torque values are based achieving 12,500 psi gasket stress or at minimum above 10,000 psi gasket stress without exceeding 80,000 psi bolt stress or PCC-1 2019 FEA SA105 Max. Stud Stress Before Flange Yielding.

 Cases where gasket stress is >10,000 < 12,500 psi

Optimal Torque Values:

^[3] Optimal torque values are based on 25,000 psi optimum gasket stress without exceeding 80,000 psi bolt stress or 500 psi below PCC-1 2019 FEA SA105 Max. Stud Stress Before Flange Yielding.

 Cases where torque equals ≤ 60,000 bolts stress

 Cases where torque equals > 60,000 ≤ 75,000 bolts stress

 Cases where torque equals > 75,000 ≤ 80,000 bolts stress

*Cases where gasket stress is ≥ 15,000 < 25,000 psi, **Cases where gasket stress is ≥ 12,500 < 15,000 psi, ***Cases where gasket stress is ≥ 10,000 < 12,500 psi

Max. Torque Values:

^[4] Max. torque values are based on; max allowable 40,000 psi gasket stress; PCC-1 2019 FEA SA105 Max. Stud Stress Before Flange Yielding, or 80,000 psi bolt stress, whichever occurs 1st. Note: In some cases the max. torque values may be equal to the optimal torque values in order to optimize gasket stress levels.

^[5] ½" through 1 ½" NPS & 3 ½" NPS due to "No Data" on flange yielding; Max. torque values are set to achieve max gasket stress of 40,000 or 80,000 psi bolt stress, whichever occurs 1st.

 Cases where torque is based on 80,000 bolts stress.

 Cases where torque is based on PCC-1 2019 FEA SA105 Max. Stud Stress Before Flange Yielding.

 Cases where torque is based on max. allowable 40,000 psi gasket stress.

Torque Values - Durlon® Spiral Wound Gaskets – Class 400 & 600

Pipe Size	ASME B16.20 SWG Gasket, Ft.-Lbs (N-M)					
	Fasteners: A193-B7 or B16 lubricated with a never seize type lubricant, k = 0.17					
	Class 400			Class 600		
	Min. [1, 2]	Optimal [1, 3]	Max. [4, 5]	Min. [1, 2]	Optimal [1, 3]	Max. [4, 5]
½"	20 (27)	35 (47)	55 (75)	20 (27)	35 (47)	55 (75)
¾"	35 (47)	65 (88)	100 (136)	35 (47)	65 (88)	100 (136)
1"	45 (61)	90 (122)	135 (183)	45 (61)	90 (122)	135 (183)
1 ¼"	50 (68)	100 (136)	150 (203)	55 (75)	100 (136)	150 (203)
1 ½"	90 (122)	170 (230)	250 (339)	95 (129)	170 (230)	250 (339)
2"	50 (68)	90 (122)	125 (169)	50 (68)	95 (129)	135 (183)
2 ½"	70 (95)	130 (176)	185 (251)	75 (102)	135 (183)	185 (251)
3"	100 (136)	190 (258)	260 (353)	110 (149)	195 (264)	275 (373)
3 ½"	180 (244)	345 (468)	455 (617)	190 (258)	355 (481)	455 (617)
4"	210 (285)	395 (536)	420 (569)	225 (305)	410 (556)	455 (617)
5"	270 (366)	*430 (583)	455 (617)	335 (454)	600 (813)	685 (929)
6"	250 (339)	*430 (583)	455 (617)	305 (414)	550 (746)	685 (929)
8"	405 (549)	*645 (875)	685 (929)	500 (678)	880 (1193)	1005 (1363)
10"	475 (644)	*785 (1064)	795 (1078)	580 (786)	1010 (1369)	1370 (1857)
12"	705 (956)	**735 (997)	745 (1010)	620 (841)	1070 (1451)	1300 (1763)
14"	600 (813)	*885 (1200)	930 (1261)	735 (997)	1250 (1695)	1620 (2196)
16"	860 (1166)	*1250 (1695)	1260 (1708)	1045 (1417)	1775 (2407)	2165 (2935)
18"	920 (1247)	*1440 (1952)	1515 (2054)	1455 (1973)	2470 (3349)	3195 (4332)
20"	1135 (1539)	*1650 (2237)	1665 (2257)	1385 (1878)	2305 (3125)	2930 (3973)
22"	1230 (1668)	*2075 (2813)	2145 (2908)	1535 (2081)	*2450 (3322)	2905 (3939)
24"	1670 (2264)	*2450 (3322)	2710 (3674)	2055 (2786)	3335 (4522)	4050 (5491)

Disclaimer: This is a general guide only and TFC/GRI, does not accept responsibility for negligence or misuse of this information.

General Notes:

- a) Torque Values are in ft.-lbs. and assume new A193 Gr. B7 or B16 fasteners with 2H heavy hex nuts; with studs, nuts and the nut bearing surfaces lubricated with a never-seize type lubricant (k = 0.17).
- b) A193 Gr. B7 & B16 fasteners have the same yield strength up to 4" diameter. There are "no" fasteners above 4" diameter in this chart.
- c) All torque values are based on using a "calibrated" torque wrench.
- d) All torque values in the chart above are based on the use of an inner/outer ring style (DRI) spiral wound gasket.
- e) All torque values in the chart above are based on using the tensile area of the fastener.
- f) All torque values in chart are rounded to nearest 5 ft.-lbs.

Footnotes:

[1] Torque values are based using ASME B16.5-2020 MAWP (Maximum Allowable Working Pressure) at ambient in the gasket stress calculation.

Min. Torque Values:

[2] Min. torque values are based achieving 12,500 psi gasket stress or at minimum above 10,000 psi gasket stress without exceeding 80,000 psi bolt stress or PCC-1 2019 FEA SA105 Max. Stud Stress Before Flange Yielding.

Optimal Torque Values:

[3] Optimal torque values are based on 25,000 psi optimum gasket stress without exceeding 80,000 psi bolt stress or 500 psi below PCC-1 2019 FEA SA105 Max. Stud Stress Before Flange Yielding.

- Cases where torque equals ≤ 60,000 bolts stress
- Cases where torque equals > 60,000 ≤ 75,000 bolts stress
- Cases where torque equals > 75,000 ≤ 80,000 bolts stress

*Cases where gasket stress is ≥ 15,000 < 25,000 psi, **Cases where gasket stress is ≥ 12,500 < 15,000 psi, ***Cases where gasket stress is ≥ 10,000 < 12,500 psi

Max. Torque Values:

[4] Max. torque values are based on; max allowable 40,000 psi gasket stress; PCC-1 2019 FEA SA105 Max. Stud Stress Before Flange Yielding, or 80,000 psi bolt stress, whichever occurs 1st. Note: In some cases the max. torque values may be equal to the optimal torque values in order to optimize gasket stress levels.

[5] ½" through 1 ½" NPS & 3 ½" NPS due to "No Data" on flange yielding; Max. torque values are set to achieve max gasket stress of 40,000 or 80,000 psi bolt stress, whichever occurs 1st.

- Cases where torque is based on 80,000 bolts stress.
- Cases where torque is based on PCC-1 2019 FEA SA105 Max. Stud Stress Before Flange Yielding.
- Cases where torque is based on max. allowable 40,000 psi gasket stress.

Torque Values - Durlon® Spiral Wound Gaskets – Class 900, 1500 & 2500

Pipe Size	ASME B16.20 SWG Gasket, Ft-Lbs (N-M)								
	Fasteners: A193-B7 or B16 lubricated with a never seize type lubricant, k = 0.17								
	Class 900			Class 1500			Class 2500		
	Min. [1, 2]	Optimal [1, 3]	Max. [4, 5]	Min. [1, 2]	Optimal [1, 3]	Max. [4, 5]	Min. [1, 2]	Optimal [1, 3]	Max. [4, 5]
1/2"	30 (41)	55 (75)	85 (115)	30 (41)	55 (75)	85 (115)	35 (47)	60 (81)	85 (115)
3/4"	40 (54)	80 (108)	120 (163)	45 (61)	85 (115)	120 (163)	50 (68)	90 (122)	120 (163)
1"	70 (95)	130 (176)	190 (258)	75 (102)	135 (183)	190 (258)	85 (115)	145 (197)	190 (258)
1 1/4"	110 (149)	210 (285)	315 (427)	120 (163)	220 (298)	315 (427)	155 (210)	270 (366)	360 (488)
1 1/2"	160 (217)	305 (414)	450 (610)	175 (237)	315 (427)	450 (610)	225 (305)	385 (522)	505 (685)
2"	105 (142)	200 (271)	295 (400)	115 (156)	210 (285)	295 (400)	150 (203)	260 (353)	340 (461)
2 1/2"	155 (210)	290 (393)	415 (563)	170 (230)	300 (407)	415 (563)	220 (298)	370 (502)	470 (637)
3"	165 (224)	295 (400)	415 (563)	260 (353)	445 (603)	585 (793)	345 (468)	555 (752)	655 (888)
4"	315 (427)	555 (752)	750 (1017)	425 (576)	715 (969)	915 (1241)	620 (841)	965 (1308)	1095 (1485)
5"	460 (624)	795 (1078)	1060 (1437)	695 (942)	1155 (1566)	1445 (1959)	1000 (1356)	1550 (2102)	1685 (2285)
6"	380 (515)	655 (888)	865 (1173)	575 (780)	935 (1268)	1145 (1552)	1565 (2122)	2355 (3193)	2505 (3396)
8"	630 (854)	1055 (1430)	1330 (1803)	975 (1322)	1550 (2102)	1830 (2481)	1530 (2074)	*2120 (2874)	2255 (3057)
10"	630 (854)	1010 (1369)	1210 (1641)	1575 (2135)	2470 (3349)	2770 (3756)	2690 (3647)	*3225 (4373)	3435 (4657)
12"	730 (900)	1190 (1613)	1460 (1979)	1665 (2257)	2510 (3403)	2655 (3600)	4180 (5667)	*5175 (7016)	5510 (7471)
14"	905 (1227)	1455 (1973)	1740 (2359)	2055 (2786)	*2665 (3613)	2815 (3817)	-	-	-
16"	1205 (1634)	1900 (2576)	2165 (2935)	3125 (4237)	*4480 (6074)	4730 (6413)	-	-	-
18"	1910 (2590)	3075 (4169)	3640 (4935)	4445 (6027)	*6230 (8447)	6670 (9043)	-	-	-
20"	2235 (3030)	3450 (4678)	3830 (5193)	5680 (7701)	*7600 (10304)	8025 (10880)	-	-	-
24"	3680 (4989)	*5425 (7354)	5730 (7769)	9180 (12446)	*11770 (15958)	12415 (16833)	-	-	-

Disclaimer: This is a general guide only and TFC/GRI, does not accept responsibility for negligence or misuse of this information.

General Notes:

- a) Torque Values are in ft.-lbs. and assume new A193 Gr. B7 or B16 fasteners with 2H heavy hex nuts; with studs, nuts and the nut bearing surfaces lubricated with a never-seize type lubricant (k = 0.17).
- b) A193 Gr. B7 & B16 fasteners have the same yield strength up to 4" diameter. There are "no" fasteners above 4" diameter in this chart.
- c) All torque values are based on using a "calibrated" torque wrench.
- d) All torque values in the chart above are based on the use of an inner/outer ring style (DRI) spiral wound gasket.
- e) All torque values in the chart above are based on using the tensile area of the fastener.
- f) All torque values in chart are rounded to nearest 5 ft.-lbs.

Footnotes:

[1] Torque values are based using ASME B16.5-2020 MAWP (Maximum Allowable Working Pressure) at ambient in the gasket stress calculation.

Min. Torque Values:

[2] Min. torque values are based achieving 12,500 psi gasket stress or at minimum above 10,000 psi gasket stress without exceeding 80,000 psi bolt stress or PCC-1 2019 FEA SA105 Max. Stud Stress Before Flange Yielding.

Optimal Torque Values:

[3] Optimal torque values are based on 25,000 psi optimum gasket stress without exceeding 80,000 psi bolt stress or 500 psi below PCC-1 2019 FEA SA105 Max. Stud Stress Before Flange Yielding.

- Cases where torque equals ≤ 60,000 bolts stress
- Cases where torque equals > 60,000 ≤ 75,000 bolts stress
- Cases where torque equals > 75,000 ≤ 80,000 bolts stress

*Cases where gasket stress is ≥ 15,000 < 25,000 psi, **Cases where gasket stress is ≥ 12,500 < 15,000 psi, ***Cases where gasket stress is ≥ 10,000 < 12,500 psi

Max. Torque Values:

[4] Max. torque values are based on; max allowable 40,000 psi gasket stress; PCC-1 2019 FEA SA105 Max. Stud Stress Before Flange Yielding, or 80,000 psi bolt stress, whichever occurs 1st. Note: In some cases the max. torque values may be equal to the optimal torque values in order to optimize gasket stress levels.

[5] 1/2" through 1 1/2" NPS & 3 1/2" NPS due to "No Data" on flange yielding; Max. torque values are set to achieve max gasket stress of 40,000 or 80,000 psi bolt stress, whichever occurs 1st.

- Cases where torque is based on 80,000 bolts stress.
- Cases where torque is based on PCC-1 2019 FEA SA105 Max. Stud Stress Before Flange Yielding.
- Cases where torque is based on max. allowable 40,000 psi gasket stress.

Chemical Resistance - Non-Metallic Gaskets

The following information is a general guide only for the selection of a suitable gasket material as there are unlimited combinations of fluid, pressure, and temperature conditions.

A = Acceptable C = Caution-Dependent on Conditions NS = Not Suitable - = No Data Available

Fluid	Durlon® Compressed Non-Asbestos Sheet						Durlon® PTFE					Durlon® Flexible Graphite			Durlon® HT1000®		
	5000 7900 7910 7925 7950	8300 8900	8400	8500	8600	8700	9000 9000N 9002	9200	9400	Virgin Joint Sealant 9600	9645	FGS95	CFG FGL316 FGM316	FGT316	S90	L316	T316
Acetaldehyde	NS	NS	NS	NS	NS	NS	A	A	A	A	A	A	A	A	C	C	C
Acetic Acid (<5%)	A	A	A	A	A	A	A	A	A	A	A	A	A	A	A	A	A
Acetic Acid (6-37%)	NS	NS	NS	NS	NS	NS	A	A	A	A	C	A	A	A	A	A	A
Acetic Acid Glacial	NS	NS	NS	NS	NS	NS	A	A	A	A	-	A	A	A	A	A	A
Acetic Anhydride	C	C	C	C	C	A	A	A	A	A	C	A	A	A	-	-	-
Acetone	NS	NS	NS	NS	NS	NS	A	A	A	A	A	A	A	A	C	C	C
Acetonitrile	NS	NS	NS	NS	NS	A	A	A	A	A	A	NS	NS	NS	-	-	-
Acetylene	A	A	A	A	NS	A	A	A	A	A	A	A	A	A	C	C	C
Acrolein	NS	NS	NS	NS	NS	NS	A	A	A	A	C	NS	NS	NS	-	-	-
Acrylic Acid	NS	NS	NS	NS	NS	NS	A	A	A	A	C	A	NS	NS	-	-	-
Acrylonitrile	NS	NS	NS	NS	NS	NS	A	A	A	A	C	A	A	A	-	-	-
Air	A	A	A	A	A	A	A	A	A	A	A	A	A	A	A	A	A
Alum	A	A	A	A	A	A	A	A	A	A	A	A	A	A	A	A	A
Aluminum Acetate	A	A	A	A	NS	A	A	A	A	A	-	C	C	C	A	A	A
Aluminum Chloride	A	A	A	A	A	A	A	A	A	A	A	A	A	-	A	-	-
Aluminum Fluoride	A	A	A	A	A	A	-	A	A	A	A	A	A	-	-	-	-
Aluminum Hydroxide	A	A	A	A	A	A	A	A	A	A	A	A	NS	NS	A	-	-
Aluminum Nitrate	A	A	A	A	A	A	A	A	NS	A	A	C	C	C	-	-	-
Aluminum Sulfate	A	A	A	A	A	A	A	A	A	A	A	A	NS	NS	-	-	-
Amines	NS	NS	NS	NS	NS	NS	A	A	A	A	-	A	A	A	-	-	-
Ammonia, Gas (<110°F)	C	A	A	A	A	A	A	A	A	A	A	A	C	C	A	-	-
Ammonia, Gas (>110°F)	NS	NS	NS	NS	NS	NS	A	A	A	A	A	A	NS	NS	A	-	-
Ammonia Aqueous Liquid	C	A	A	A	NS	A	-	-	-	-	-	A	A	-	-	-	-
Ammonia, (Liquid Anhydrous)	C	A	A	A	NS	NS	A	A	A	A	A	A	A	A	A	A	A
Ammonium Bisulfite	A	A	A	A	C	A	A	A	A	A	-	NS	NS	NS	-	-	-
Ammonium Chloride	A	A	A	A	A	A	A	A	A	A	A	A	A	A	A	A	A
Ammonium Hydroxide (<10%)	A	A	A	A	NS	A	A	A	A	A	A	-	-	-	-	-	-
Ammonium Hydroxide (Sat'd)	A	A	A	A	NS	C	-	-	-	-	A	-	-	-	-	-	-
Ammonium Nitrate	A	A	A	A	A	A	A	A	NS	A	A	A	A	A	-	-	-
Ammonium Phosphate	A	A	A	A	A	A	A	A	A	A	A	A	A	A	-	-	-
Ammonium Sulfate	A	A	A	A	A	A	A	A	A	A	A	A	A	A	-	-	-
Ammonium Sulfide	A	A	A	A	C	A	A	A	A	A	-	-	-	-	-	-	-
Amyl Chloride	NS	NS	NS	NS	NS	NS	A	A	A	A	-	A	A	A	A	A	A
Aniline, Aniline Oil	NS	NS	NS	NS	NS	NS	A	A	A	A	A	A	A	A	C	C	C
Aqua Regia	NS	NS	NS	NS	NS	NS	A	A	NS	A	A	NS	NS	NS	-	-	-
Arsenic Acid	A	A	A	A	A	A	A	A	A	A	A	A	A	A	-	-	-
Asphalt	A	A	A	A	NS	NS	A	A	A	A	A	A	A	A	A	A	A
Aviation Fuels	A	A	A	A	NS	NS	A	A	A	A	A	A	A	A	A	A	A
Baking Soda	A	A	A	A	A	A	A	A	A	A	A	A	A	A	A	A	A
Barium Chloride	A	A	A	A	A	A	A	A	A	A	A	A	A	A	A	A	A
Barium Hydroxide	A	A	A	A	A	A	A	A	A	A	A	A	A	-	-	-	-
Barium Sulfate	A	A	A	A	A	A	-	-	-	-	-	A	A	-	-	-	-
Barium Sulfide	A	A	A	A	A	A	A	A	A	A	A	A	A	-	-	-	-
Beer	A	A	A	A	A	A	A	A	A	A	A	A	A	A	A	A	A
Benzaldehyde	NS	NS	NS	NS	NS	NS	A	A	A	A	A	A	A	A	-	-	-
Benzene (Benzol)	NS	NS	NS	NS	NS	NS	A	A	A	A	A	A	A	A	C	C	C
Benzoic Acid	NS	NS	NS	NS	NS	NS	A	A	A	A	A	A	A	A	A	A	A

Chemical Resistance - Non-Metallic Gaskets

The following information is a general guide only for the selection of a suitable gasket material as there are unlimited combinations of fluid, pressure, and temperature conditions.

A = Acceptable C = Caution-Dependent on Conditions NS = Not Suitable - = No Data Available

Fluid	Durlon® Compressed Non-Asbestos Sheet						Durlon® PTFE					Durlon® Flexible Graphite			Durlon® HT1000®		
	5000 7900 7910 7925 7950	8300 8900	8400	8500	8600	8700	9000 900N 9002	9200	9400	Virgin Joint Sealant 9600	9645	FGS95	CFG FGL316 FGM316	FGT316	S90	L316	T316
Benzoyl Chloride	NS	NS	NS	NS	NS	NS	A	A	A	A	A	C	NS	NS	-	-	-
Benzyl Alcohol	NS	NS	NS	NS	NS	C	A	A	A	A	A	A	C	C	-	-	-
Benzyl Chloride	NS	NS	NS	NS	NS	NS	A	A	A	A	A	A	A	A	-	-	-
Black Sulfate Liquor (<200°F)	C	A	A	A	NS	NS	A	A	A	A	A	C	C	C	C	C	C
Black Sulfate Liquor (>200°F)	NS	NS	NS	NS	NS	NS	A	A	A	A	A	NS	NS	NS	NS	NS	NS
Bleach Solutions (Sodium Hypochlorite)	NS	NS	NS	NS	NS	NS	A	A	C	A	A	C	NS	NS	A	-	-
Biodiesel (<B15)	A	A	A	A	NS	NS	A	A	NS	A	-	-	-	-	-	-	-
Biodiesel (>B15)	NS	NS	NS	NS	NS	NS	A	A	NS	A	A	-	-	-	-	-	-
Boiler Feed Water	A	A	A	A	A	A	A	A	A	A	A	A	A	A	A	A	A
Borax	A	A	A	A	A	A	A	A	A	A	A	A	A	A	A	A	A
Boric Acid	A	A	A	A	A	A	A	A	A	A	A	A	A	A	A	A	A
Brine	A	A	A	A	A	A	A	A	A	A	A	A	C	C	-	-	-
Bromine (Liquid)	NS	NS	NS	NS	NS	NS	A	A	A	A	A	-	-	-	-	-	-
Bromine (Gas)	NS	NS	NS	NS	NS	NS	A	A	A	A	A	-	-	-	-	-	-
Butadiene	NS	NS	NS	NS	NS	NS	A	A	A	A	C	A	A	A	A	A	A
Butane	A	A	A	A	NS	C	A	A	A	A	A	A	A	A	A	A	A
2-Butanone	NS	NS	NS	NS	NS	NS	A	A	A	A	A	A	A	A	C	C	C
Butyl Acetate	NS	NS	NS	NS	NS	NS	A	A	A	A	A	A	A	A	C	C	C
Butyl Alcohol (Butanol)	A	A	A	A	A	A	A	A	A	A	A	A	A	A	C	C	C
n-Butyl Amine	C	C	C	C	NS	NS	A	A	A	A	A	A	A	A	C	C	C
tert-Butyl Amine	NS	NS	NS	NS	NS	NS	A	A	A	A	A	A	A	A	-	-	-
Butyl Methacrylate	NS	NS	NS	NS	NS	NS	A	A	A	A	C	C	NS	NS	-	-	-
Butylene (Butene)	A	A	A	A	NS	C	A	A	A	A	-	A	A	A	-	-	-
Butyric Acid	NS	NS	NS	NS	NS	NS	A	A	A	A	A	A	A	A	C	C	C
Calcium Bisulfite	A	A	A	A	NS	A	A	A	A	A	A	A	A	A	-	-	-
Calcium Carbonate	A	A	A	A	A	A	A	A	A	A	-	A	A	A	-	-	-
Calcium Chlorate	A	A	A	A	NS	A	-	-	-	-	-	Y	-	-	-	-	-
Calcium Chloride	A	A	A	A	A	A	A	A	A	A	A	A	A	A	A	A	A
Calcium Hydroxide	A	A	A	A	A	A	A	A	A	A	A	A	A	A	A	A	A
Calcium Hypochlorite	NS	NS	NS	NS	NS	NS	A	A	A	A	A	A	A	A	A	A	A
Calcium Nitrate	A	A	A	A	A	A	A	A	NS	A	A	A	A	A	-	-	-
Calcium Sulfate	A	A	A	A	NS	C	-	-	-	-	-	A	A	A	A	-	-
Caprolactam	NS	NS	NS	NS	NS	NS	A	A	A	A	A	NS	NS	NS	-	-	-
Carbon Dioxide, dry	A	A	A	A	C	C	A	A	A	A	A	A	A	A	A	A	A
Carbon Dioxide, wet	A	A	A	A	C	C	A	A	A	A	A	A	A	A	A	A	A
Carbon Disulfide	NS	NS	NS	NS	NS	NS	A	A	A	A	A	A	A	A	C	C	C
Carbon Monoxide	A	A	A	A	NS	C	A	A	A	A	A	A	A	A	A	A	A
Carbon Tetrachloride	NS	NS	NS	NS	NS	NS	A	A	A	A	A	A	A	A	C	C	C
Castor Oil	A	A	A	A	C	A	A	A	A	A	A	A	A	A	A	-	-
Caustic Potash	C	C	C	C	C	C	C	C	C	A	-	A	A	A	A	A	A
Caustic Soda (NaOH) (<10%)	A	A	A	A	C	A	A	A	A	A	C	A	-	-	-	-	-
Caustic Soda (NaOH) (10-50%)	NS	NS	NS	NS	NS	NS	C	A	A	A	C	A	-	-	-	-	-
Chloric Acid	NS	NS	NS	NS	NS	NS	-	-	-	A	-	-	-	-	-	-	-
Chlorine, liquid (Dry)	NS	NS	NS	NS	NS	NS	A	A	A	A	A	A	C	C	-	-	-
Chlorine Liquid	NS	NS	NS	NS	NS	NS	A	A	A	A	A	A	NS	NS	-	-	-
Chlorine Dioxide	NS	NS	NS	NS	NS	NS	A	A	NS	A	A	C	NS	NS	-	-	-
Chlorine Gas (Dry)	NS	NS	NS	NS	NS	NS	A	A	A	A	A	-	-	-	-	-	-

Chemical Resistance - Non-Metallic Gaskets

The following information is a general guide only for the selection of a suitable gasket material as there are unlimited combinations of fluid, pressure, and temperature conditions.

A = Acceptable C = Caution-Dependent on Conditions NS = Not Suitable - = No Data Available

Fluid	Durlon® Compressed Non-Asbestos Sheet						Durlon® PTFE					Durlon® Flexible Graphite			Durlon® HT1000®		
	5000 7900 7910 7925 7950	8300 8900	8400	8500	8600	8700	9000 9000N 9002	9200	9400	Virgin Joint Sealant 9600	9645	FGS95	CFG FGL316 FGM316	FGT316	S90	L316	T316
Chlorine Gas (Wet)	NS	NS	NS	NS	NS	NS	A	A	A	A	A	-	-	-	-	-	-
Chlorinated Water (<3500ppm)	NS	NS	NS	NS	NS	NS	A	A	A	A	A	-	-	-	-	-	-
Chlorinated Water (>3500ppm)	NS	NS	NS	NS	NS	NS	A	A	A	A	A	-	-	-	-	-	-
Chlorobenzene	NS	NS	NS	NS	NS	NS	A	A	A	A	A	A	A	A	-	-	-
Chloroethane	A	A	A	A	NS	NS	A	A	A	A	A	A	A	A	-	-	-
Chloroethylene	NS	NS	NS	NS	NS	NS	A	A	A	A	A	A	C	C	-	-	-
Chloroform	NS	NS	NS	NS	NS	NS	A	A	A	A	A	A	A	A	C	C	C
Chlorosulfonic Acid	NS	NS	NS	NS	NS	NS	A	A	-	A	A	A	-	-	-	-	-
Chromic Acid	NS	NS	NS	NS	NS	NS	A	A	NS	A	A	A	A	A	C	C	C
Chromic Acid (10%)	-	-	-	-	-	-	A	A	-	A	-	-	-	-	-	-	-
Chromic Acid (30%)	-	-	-	-	-	-	A	A	-	A	-	-	-	-	-	-	-
Chromic Acid (40%)	-	-	-	-	-	-	A	A	-	A	-	-	-	-	-	-	-
Chromic Acid (50%)	-	-	-	-	-	-	A	A	-	A	-	-	-	-	-	-	-
Citric Acid	A	A	A	A	A	A	A	A	A	A	A	A	A	A	A	A	A
Coal Gas	NS	NS	NS	NS	NS	A	A	A	A	A	-	A	A	A	A	A	A
Coconut Oil	A	A	A	A	NS	C	A	A	-	-	-	A	A	A	-	-	-
Coke Oven Gas	NS	NS	NS	NS	NS	NS	A	A	A	A	A	-	-	-	-	-	-
Copper Acetate	A	A	A	A	NS	A	-	-	-	-	-	A	A	A	A	-	-
Copper Chloride	A	A	A	A	A	A	A	A	A	A	A	-	-	-	-	-	-
Copper Sulfate	A	A	A	A	A	A	A	A	A	A	A	A	A	A	A	A	A
Corn Oil	A	A	A	A	NS	C	A	A	A	A	A	A	A	A	A	A	A
Cotton Seed Oil	A	A	A	A	NS	A	A	A	A	A	A	A	A	A	A	A	A
Creosote (Coal Tar)	A	A	A	A	NS	NS	A	A	A	A	A	A	A	A	A	A	A
Cresol	NS	NS	NS	NS	NS	NS	A	A	A	A	A	A	A	A	A	A	A
Crude Oil	A	A	A	A	NS	C	A	A	A	A	A	A	A	A	A	A	A
Cumene	NS	NS	NS	NS	NS	NS	A	A	A	A	A	-	-	-	-	-	-
Cyclohexane	C	C	C	C	NS	C	A	A	A	A	A	A	A	A	-	-	-
Cyclohexanone	NS	NS	NS	NS	NS	NS	A	A	A	A	A	A	A	A	A	A	A
Detergent Solutions	A	A	A	A	A	A	A	A	A	A	-	A	A	A	A	A	A
Diacetone Alcohol	NS	NS	NS	NS	NS	NS	A	A	A	A	-	A	A	A	-	-	-
Diazomethane	NS	NS	NS	NS	NS	NS	A	A	A	A	A	NS	NS	NS	-	-	-
Dibenzyl Ether	NS	NS	NS	NS	NS	NS	A	A	A	A	A	A	NS	NS	C	NS	NS
Dibutylamine	NS	NS	NS	NS	NS	NS	A	A	A	A	-	-	-	-	-	-	-
Dichlorobenzene	NS	NS	NS	NS	NS	NS	A	A	A	A	A	A	A	A	-	-	-
Dichlorobenzidene	NS	NS	NS	NS	NS	NS	A	A	A	A	A	NS	NS	NS	-	-	-
Dichloroethylene	NS	NS	NS	NS	NS	NS	A	A	A	A	-	A	A	A	-	-	-
Dichloroethyl Ether	NS	NS	NS	NS	NS	NS	A	A	A	A	A	-	-	-	-	-	-
Dichloromethane	NS	NS	NS	NS	NS	NS	A	A	A	A	A	A	NS	NS	-	-	-
Diesel Fuel	A	A	A	A	NS	C	A	A	A	A	A	A	A	A	A	A	A
Dimethylamine	NS	NS	NS	NS	NS	NS	A	A	A	A	-	-	-	-	-	-	-
Diethyl Carbonate	NS	NS	NS	NS	NS	NS	A	A	A	A	A	A	NS	NS	-	-	-
Dimethyl Acetamide	NS	NS	NS	NS	NS	NS	A	A	A	A	-	-	-	-	-	-	-
Dimethylformamide (DMF)	NS	NS	NS	NS	NS	NS	A	A	A	A	A	-	-	-	-	-	-
Dioxane	NS	NS	NS	NS	NS	NS	A	A	A	A	A	A	-	-	-	-	-
Dowtherm A	NS	NS	NS	NS	NS	NS	A	A	A	A	-	A	A	A	-	-	-
Dowtherm E	NS	NS	NS	NS	NS	NS	A	A	A	A	-	A	A	A	-	-	-
Dowtherm J	NS	NS	NS	NS	NS	NS	A	A	A	A	-	A	A	A	-	-	-
Epichlorohydrin	NS	NS	NS	NS	NS	NS	A	A	A	A	A	A	C	C	-	-	-

Chemical Resistance - Non-Metallic Gaskets

The following information is a general guide only for the selection of a suitable gasket material as there are unlimited combinations of fluid, pressure, and temperature conditions.

A = Acceptable C = Caution-Dependent on Conditions NS = Not Suitable - = No Data Available

Fluid	Durlon® Compressed Non-Asbestos Sheet						Durlon® PTFE					Durlon® Flexible Graphite			Durlon® HT1000®		
	5000 7900 7910 7925 7950	8300 8900	8400	8500	8600	8700	9000 9000N 9002	9200	9400	Virgin Joint Sealant 9600	9645	FGS95	CFG FGL316 FGM316	FGT316	S90	L316	T316
Ethane	A	A	A	A	NS	C	A	A	A	A	A	A	A	A	A	A	A
Ether	NS	NS	NS	NS	NS	NS	A	A	A	A	A	A	A	A	-	-	-
Ethyl Acetate	NS	NS	NS	NS	NS	NS	A	A	A	A	A	A	A	A	C	C	C
Ethyl Alcohol (Ethanol)	A	A	A	A	A	A	A	A	A	A	A	A	A	A	C	C	C
Ethylbenzene	NS	NS	NS	NS	NS	NS	A	A	A	A	A	A	A	A	-	-	-
Ethylchloride	A	A	A	A	C	NS	A	A	A	A	A	A	A	A	C	C	C
Ethylene	A	A	A	A	C	NS	A	A	A	A	A	A	A	A	C	C	C
Ethylene Bromide	NS	NS	NS	NS	NS	NS	A	A	A	A	A	A	-	-	-	-	-
Ethylene Dichloride (EDC)	NS	NS	NS	NS	NS	NS	A	A	A	A	A	A	A	A	-	-	-
Ethylene Glycol	A	A	A	A	A	A	A	A	A	A	A	A	A	A	A	A	A
Ethyl Ether	NS	NS	NS	NS	C	NS	A	A	A	A	A	A	A	A	C	C	C
Ethylene Oxide	NS	NS	NS	NS	NS	NS	A	A	A	A	C	A	A	A	-	-	-
Fatty Acids	A	A	A	A	NS	C	A	A	A	A	-	A	A	A	A	A	A
Ferric Chloride	A	A	A	A	A	A	A	A	A	A	A	A	NS	NS	-	-	-
Ferric Hydroxide	A	A	A	A	NS	A	-	-	-	-	-	-	-	-	-	-	-
Ferric Nitrate	A	A	A	A	A	A	-	-	-	-	-	A	A	-	-	-	-
Ferrous Chloride	A	A	A	A	NS	A	A	A	A	A	-	A	NS	NS	-	-	-
Ferrous Sulfate	A	A	A	A	A	A	-	-	-	-	-	C	C	C	-	-	-
Fish Oil	A	A	A	A	NS	A	-	-	-	-	-	A	-	-	-	-	-
Flue Gas	A	A	A	A	NS	NS	-	-	-	-	-	A	-	-	-	-	-
Fluorine Gas (Dry)	NS	NS	NS	NS	NS	NS	NS	NS	C	A	-	A	-	-	-	-	-
Fluorine Gas (Wet)	NS	NS	NS	NS	NS	NS	NS	NS	C	A	-	-	-	-	-	-	-
Formaldehyde	A	A	A	A	C	C	A	A	A	A	A	A	A	A	C	C	C
Formic Acid	NS	NS	NS	NS	C	A	A	A	A	A	A	A	A	A	A	A	A
Freon (See Refrigerants)	-	-	-	-	-	-	-	-	-	-	-	-	-	-	-	-	-
Fuel Oil	A	A	A	A	NS	C	A	A	A	A	A	A	A	A	A	A	A
Gas, Natural	A	A	A	A	NS	A	A	A	A	A	A	A	A	A	A	A	A
Gasoline	A	A	A	A	NS	NS	A	A	A	A	A	A	A	A	C	C	C
Gasoline Sour	A	A	A	A	NS	NS	A	A	A	A	-	-	-	-	-	-	-
Gelatin	A	A	A	A	A	A	A	A	A	A	A	A	A	-	-	-	-
Glucose	A	A	A	A	A	A	A	A	A	A	A	A	A	A	A	A	A
Glycerin (Glycerol)	A	A	A	A	A	A	A	A	A	A	A	A	A	A	A	A	A
Green Sulfate Liquor	C	C	C	C	NS	C	A	A	A	A	A	C	C	C	-	-	-
Glycol	A	A	A	A	NS	A	A	A	A	A	A	A	C	C	A	C	C
Heptane	A	A	A	A	NS	C	A	A	A	A	A	A	A	A	A	A	A
Hexane	A	A	A	A	NS	C	A	A	A	A	A	A	A	A	A	A	A
Hydraulic Oil (Mineral)	A	A	A	A	NS	C	A	A	A	A	-	A	A	A	A	A	A
Hydraulic Oil (Phosp. Ester)	NS	NS	NS	NS	NS	NS	A	A	A	A	-	A	A	A	A	A	A
Hydrazine	C	C	C	C	C	C	A	A	A	A	A	A	A	A	A	A	A
Hydrochloric Acid (<30%)	NS	NS	NS	NS	NS	NS	A	A	A	A	-	-	-	-	-	-	-
Hydrochloric Acid (>30%)	NS	NS	NS	NS	NS	NS	A	A	A	A	-	A	NS	NS	A	NS	NS
Hydrofluoric Acid	NS	NS	NS	NS	NS	NS	NS	NS	A	A	-	A	NS	NS	-	-	-
Hydrogen	A	A	A	A	A	A	A	A	A	A	A	A	A	A	A	A	A
Hydrogen Chloride, (Dry)	NS	NS	NS	NS	NS	NS	A	A	A	A	-	A	NS	NS	-	-	-
Hydrogen Fluoride (HF)	NS	NS	NS	NS	NS	NS	NS	NS	A	A	A	A	NS	NS	A	NS	NS
Hydrogen Peroxide (10%)	C	C	C	C	C	C	A	A	A	A	A	C	C	C	A	A	A
Hydrogen Peroxide (50%)	NS	NS	NS	NS	NS	NS	A	A	-	A	A	-	-	-	-	-	-
Hydrogen Peroxide (90%)	NS	NS	NS	NS	NS	NS	A	A	-	A	A	-	-	-	-	-	-

Chemical Resistance - Non-Metallic Gaskets

The following information is a general guide only for the selection of a suitable gasket material as there are unlimited combinations of fluid, pressure, and temperature conditions.

A = Acceptable C = Caution-Dependent on Conditions NS = Not Suitable - = No Data Available

Fluid	Durlon® Compressed Non-Asbestos Sheet						Durlon® PTFE					Durlon® Flexible Graphite			Durlon® HT1000®		
	5000 7900 7910 7925 7950	8300 8900	8400	8500	8600	8700	9000 900N 9002	9200	9400	Virgin Joint Sealant 9600	9645	FGS95	CFG FGL316 FGM316	FGT316	S90	L316	T316
Hydrogen Sulfide (Dry)	C	C	C	C	C	A	A	A	A	A	A	A	A	A	-	-	-
Hydrogen Sulfide (Wet)	NS	NS	NS	NS	NS	A	A	A	A	A	A	A	A	A	-	-	-
Hydroquinone	NS	NS	NS	NS	NS	NS	A	A	A	A	A	A	A	A	-	-	-
Iodine	A	A	A	A	A	NS	A	A	A	A	-	NS	NS	NS	-	-	-
Isobutane	A	A	A	A	NS	NS	A	A	A	A	A	A	-	-	-	-	-
Isooctane	A	A	A	A	NS	NS	A	A	A	A	A	A	A	A	A	A	A
Isopropyl Alcohol	A	A	A	A	A	A	A	A	A	A	A	A	A	A	C	C	C
Isopropyl Ether	A	A	A	A	NS	NS	A	A	-	-	-	A	A	-	-	-	-
Jet Fuel	A	A	A	A	NS	NS	A	A	A	A	A	A	A	A	A	A	A
Kerosene	A	A	A	A	NS	NS	A	A	A	A	A	A	A	A	A	A	A
Lacquer Solvents	NS	NS	NS	NS	NS	NS	A	A	A	A	A	A	A	A	A	A	A
Lactic Acid	A	A	A	A	A	A	A	A	A	A	A	A	A	A	A	A	A
Lead Sulfate	A	A	A	A	NS	A	-	-	-	-	-	-	-	-	-	-	-
Linoleic Acid	C	C	C	C	NS	NS	-	-	-	-	-	-	-	-	-	-	-
Linseed Oil	A	A	A	A	NS	C	A	A	A	A	A	A	A	A	A	A	A
Lubricating Oil	A	A	A	A	NS	C	A	A	A	A	A	A	A	A	A	A	A
Magnesium Carbonate	A	A	A	A	NS	A	-	-	-	-	-	-	-	-	-	-	-
Magnesium Chloride	A	A	A	A	A	A	A	A	A	A	A	A	NS	NS	-	-	-
Magnesium Hydroxide	A	A	A	A	A	A	A	A	A	A	A	A	A	A	-	-	-
Magnesium Sulfate	A	A	A	A	A	A	A	A	A	A	A	A	A	A	A	A	A
Maleic Acid	A	A	A	A	NS	NS	A	A	A	A	A	A	A	A	A	A	A
Maleic Anhydride	NS	NS	NS	NS	NS	NS	A	A	A	A	A	NS	NS	NS	-	-	-
Mercuric Chloride	A	A	A	A	A	C	A	A	A	A	A	NS	NS	NS	-	-	-
Mercury	A	A	A	A	A	A	A	A	A	A	A	-	-	-	-	-	-
Methane	A	A	A	A	NS	C	A	A	A	A	A	A	A	A	C	C	C
Methanol	A	A	A	A	A	A	A	A	A	A	A	A	A	A	C	C	C
Methylacrylic Acid	NS	NS	NS	NS	NS	NS	A	A	A	A	A	-	-	-	-	-	-
Methyl Acetone	NS	NS	NS	NS	NS	NS	A	A	-	-	-	-	-	-	-	-	-
Methyl Alcohol	A	A	A	A	A	A	A	A	A	A	A	A	A	A	C	C	C
Methyl Amine	C	C	C	C	NS	C	-	-	-	-	-	-	-	-	-	-	-
Methylene Chloride	NS	NS	NS	NS	NS	NS	A	A	A	A	A	A	NS	NS	C	NS	NS
Methyl Ethyl Ketone, MEK	NS	NS	NS	NS	NS	NS	A	A	A	A	A	A	A	A	C	C	C
Methyl Isobutyl Ketone	NS	NS	NS	NS	NS	NS	A	A	A	A	A	A	A	A	-	-	-
Methyl Chloride	NS	NS	NS	NS	NS	NS	A	A	A	A	A	-	-	-	C	-	-
Methyl Isocyanate	NS	NS	NS	NS	NS	NS	A	A	A	A	A	NS	NS	NS	-	-	-
Methyl Methacrylate	NS	NS	NS	NS	NS	NS	A	A	A	A	C	NS	NS	NS	-	-	-
Milk	A	A	A	A	A	A	A	A	A	A	A	A	A	A	A	A	A
Mineral Oil	A	A	A	A	NS	C	A	A	A	A	A	A	A	A	A	A	A
Muriatic Acid	NS	NS	NS	NS	NS	NS	A	A	A	A	A	A	NS	NS	-	-	-
Naphtha	A	A	A	A	C	NS	A	A	A	A	A	A	A	A	A	A	A
Naphthalene	NS	NS	NS	NS	NS	NS	A	A	A	A	A	A	A	A	-	-	-
Natural Gas	A	A	A	A	NS	A	A	A	A	A	A	A	A	A	A	A	A
Nickel Ammonium Sulfate	NS	NS	NS	NS	NS	NS	-	-	-	-	-	-	-	-	-	-	-
Nickel Nitrate	A	A	A	A	A	A	-	-	-	-	-	-	-	-	-	-	-
Nickel Sulfate	A	A	A	A	A	A	A	A	A	A	A	A	A	A	-	-	-
Nitric Acid (<30%)	NS	NS	NS	NS	NS	NS	A	A	NS	A	A	A	A	A	A	A	A
Nitric Acid (>30%)	NS	NS	NS	NS	NS	NS	A	A	NS	A	A	NS	NS	NS	A	A	A
Nitrobenzene	NS	NS	NS	NS	NS	NS	A	A	A	A	A	A	A	A	A	A	A

Chemical Resistance - Non-Metallic Gaskets

The following information is a general guide only for the selection of a suitable gasket material as there are unlimited combinations of fluid, pressure, and temperature conditions.

A = Acceptable C = Caution-Dependent on Conditions NS = Not Suitable - = No Data Available

Fluid	Durlon® Compressed Non-Asbestos Sheet						Durlon® PTFE					Durlon® Flexible Graphite			Durlon® HT1000®		
	5000 7900 7910 7925 7950	8300 8900	8400	8500	8600	8700	9000 9000N 9002	9200	9400	Virgin Joint Sealant 9600	9645	FGS95	CFG FGL316 FGM316	FGT316	S90	L316	T316
Nitrogen	A	A	A	A	A	A	A	A	A	A	A	A	A	A	A	A	A
Nitrogen Dioxide	NS	NS	NS	NS	NS	NS	A	A	NS	A	-	-	-	-	-	-	-
Nitrogen Tetroxide	NS	NS	NS	NS	NS	NS	A	A	NS	A	A	-	-	-	-	-	-
Nitrous Acid	NS	NS	NS	NS	NS	NS	-	-	-	-	-	-	-	-	-	-	-
Nitrous Oxide	A	A	A	A	NS	A	-	-	-	-	-	-	-	-	-	-	-
Octane	A	A	A	A	NS	C	A	A	A	A	A	A	A	A	A	A	A
Oil, Crude	A	A	A	A	NS	C	A	A	A	A	A	A	A	A	A	A	A
Oil, Mineral	A	A	A	A	NS	NS	A	A	A	A	A	A	A	A	A	A	A
Oleic Acid	A	A	A	A	NS	C	A	A	A	A	A	A	A	A	A	A	A
Oleum, Fuming H2SO4	NS	NS	NS	NS	NS	NS	A	NS	-	A	A	NS	NS	NS	A	-	-
Olive Oil	A	A	A	A	NS	C	-	-	-	-	-	A	A	A	-	-	-
Oxalic Acid	A	A	A	A	C	A	A	A	A	A	A	A	A	A	A	A	A
Oxygen (gas)	NS	NS	NS	NS	NS	NS	A	A	NS	A	A	A	NS	A	-	-	-
Oxygen (liquid)	NS	NS	NS	NS	NS	NS	A	A	NS	A	-	A	NS	A	-	-	-
Ozone	NS	NS	NS	NS	NS	NS	A	A	C	A	A	NS	NS	NS	-	-	-
Paraffin	A	A	A	A	NS	C	A	A	A	A	A	A	A	A	-	-	-
Pentane	A	A	A	A	NS	C	A	A	A	A	A	A	C	C	-	-	-
Perchloroethylene	NS	NS	NS	NS	NS	NS	A	A	A	A	A	A	A	A	C	C	C
Petroleum	A	A	A	A	NS	C	A	A	A	A	A	A	A	A	A	A	A
Phenol	NS	NS	NS	NS	NS	NS	A	A	A	A	A	A	A	A	A	A	A
Phosphoric Acid (<45%)	NS	NS	NS	NS	NS	NS	A	A	A	A	A	A	C	C	A	C	C
Phosphoric Acid (>45%)	NS	NS	NS	NS	NS	NS	C	A	A	A	A	A	C	C	C	C	C
Phthalic Acid	A	A	A	A	NS	NS	A	A	A	A	A	A	A	A	A	A	A
Phthalic Anhydride	NS	NS	NS	NS	NS	A	A	A	A	A	A	A	A	A	A	A	A
Polyacrylonitrile	A	A	A	A	A	A	A	A	A	A	A	A	A	A	-	-	-
Polyvinyl Acetate	A	A	A	A	NS	C	-	-	-	-	-	A	A	-	-	-	-
Potash	A	A	A	A	A	A	A	A	A	A	A	A	A	A	A	A	A
Potassium Chloride	A	A	A	A	A	A	A	A	A	A	-	A	A	A	A	A	A
Potassium Dichromate	A	A	A	A	C	C	A	A	A	A	A	A	A	A	A	A	A
Potassium Hydroxide	C	C	C	C	C	C	C	A	A	A	C	C	C	C	A	A	A
Potassium Nitrate	A	A	A	A	A	A	A	A	C	A	A	A	A	A	A	A	A
Potassium Sulfate	A	A	A	A	A	A	A	A	A	A	A	A	A	A	-	-	-
Potassium Sulfide	A	A	A	A	A	A	-	-	-	-	-	-	-	-	-	-	-
Potassium Sulfite	A	A	A	A	A	A	-	-	-	-	-	-	-	-	-	-	-
Propane	A	A	A	A	NS	C	A	A	A	A	A	A	A	A	A	A	A
Propylene	NS	NS	NS	NS	NS	NS	A	A	A	A	A	A	A	A	A	A	A
Propyl Alcohol	A	A	A	A	A	A	A	A	A	A	A	A	A	-	-	-	-
Propylene Glycol	A	A	A	A	A	A	A	A	A	A	A	A	A	-	-	-	-
Pydrauls, Skydrols	NS	NS	NS	NS	NS	NS	A	A	A	A	-	C	C	C	-	-	-
Pyridine	NS	NS	NS	NS	NS	NS	A	A	A	A	A	A	A	A	C	C	C
Red Sulfite Liquor	NS	NS	NS	NS	NS	NS	A	A	A	A	-	C	C	C	-	-	-
Red Sulfite Liquor (>380°F)	NS	NS	NS	NS	NS	NS	C	C	C	C	-	A	NS	NS	-	-	-
Refrigerant R-11	A	A	A	A	NS	NS	A	A	A	A	A	A	A	A	-	-	-
Refrigerant R-12	A	A	A	A	C	A	A	A	A	A	A	A	C	C	-	-	-
Refrigerant R-22	C	C	C	C	C	A	A	A	A	A	A	A	A	A	-	-	-
Refrigerant R-113	A	A	A	A	C	A	A	A	A	A	A	C	C	C	-	-	-
Refrigerant HCFC 123	C	NS	C	C	NS	C	A	A	A	A	A	-	-	-	-	-	-
Refrigerant HCFC 124	C	NS	C	C	NS	A	A	A	A	A	A	-	-	-	-	-	-

Chemical Resistance - Non-Metallic Gaskets

The following information is a general guide only for the selection of a suitable gasket material as there are unlimited combinations of fluid, pressure, and temperature conditions.

A = Acceptable C = Caution-Dependent on Conditions NS = Not Suitable - = No Data Available

Fluid	Durlon® Compressed Non-Asbestos Sheet						Durlon® PTFE					Durlon® Flexible Graphite			Durlon® HT1000®		
	5000 7900 7910 7925 7950	8300 8900	8400	8500	8600	8700	9000 9000N 9002	9200	9400	Virgin Joint Sealant 9600	9645	FGS95	CFG FGL316 FGM316	FGT316	S90	L316	T316
Refrigerant HFC 125	C	C	C	C	NS	A	A	A	A	A	A	-	-	-	-	-	-
Refrigerant HFC 134a	A	A	A	A	C	A	A	A	A	A	A	-	-	-	-	-	-
Refrigerant HCFC 141b	A	A	A	A	NS	A	A	A	A	A	A	-	-	-	-	-	-
Refrigerant HFC 236fa	A	A	A	A	NS	A	A	A	A	A	-	-	-	-	-	-	-
Refrigerant Blend HP 62	A	A	A	A	NS	A	A	A	A	A	A	-	-	-	-	-	-
Refrigerant Blend HP 80	C	C	C	C	NS	A	A	A	A	A	A	-	-	-	-	-	-
Refrigerant Blend HP 81	C	C	C	C	NS	A	A	A	A	A	A	-	-	-	-	-	-
Refrigerant Blend 404a	A	A	A	A	NS	A	A	A	A	A	-	-	-	-	-	-	-
Salicylic Acid	A	A	A	A	A	NS	-	-	-	-	-	-	-	-	A	-	-
Sea Water	A	A	A	A	A	A	A	A	A	A	A	A	NS	NS	A	NS	NS
Silicone Oil	A	A	A	A	A	A	A	A	-	-	-	A	A	-	A	-	-
Silver Chloride	A	A	A	A	A	A	-	-	-	-	-	-	-	-	-	-	-
Silver Nitrate	A	A	A	A	A	A	A	A	A	A	A	A	A	A	-	-	-
Soap Solutions	A	A	A	A	A	A	A	A	C	A	-	A	A	A	A	A	A
Soda Ash	A	A	A	A	A	A	A	A	A	A	A	A	A	A	A	A	A
Sodium Bicarbonate	A	A	A	A	A	A	A	A	A	A	A	A	A	A	A	A	A
Sodium Bisulfate	A	A	A	A	C	A	-	-	-	-	A	A	A	A	-	-	-
Sodium Bisulfite	A	A	A	A	C	A	A	A	A	A	A	A	A	A	A	A	A
Sodium Carbonate	A	A	A	A	A	A	A	A	A	A	-	A	A	A	A	A	A
Sodium Chloride	A	A	A	A	A	A	A	A	A	A	A	A	A	A	A	A	A
Sodium Hydroxide (<10%)	A	A	A	A	C	A	A	A	A	A	C	A	-	-	-	-	-
Sodium Hydroxide (10-50%)	NS	NS	NS	NS	NS	NS	C	A	A	A	C	A	-	-	-	-	-
Sodium Hypochlorite	NS	NS	NS	NS	C	C	A	A	C	A	A	C	NS	NS	-	-	-
Sodium Nitrate	A	A	A	A	A	A	A	A	A	A	A	-	-	-	-	-	-
Sodium Phosphate	A	A	A	A	A	A	A	A	A	A	A	A	A	A	-	-	-
Sodium Silicate	A	A	A	A	A	A	A	A	A	A	-	A	C	C	A	C	C
Sodium Sulfate	A	A	A	A	A	A	A	A	A	A	A	A	A	A	A	A	A
Sodium Sulfite	A	A	A	A	A	A	-	-	-	-	-	-	-	-	-	-	-
Sour Crude Oil	A	A	A	A	NS	C	A	A	A	A	-	A	A	A	A	A	A
Soybean Oil	A	A	A	A	NS	A	A	A	A	A	A	A	A	A	A	A	A
Steam (to 450°F)	A	A	A	A	A	A	A	A	A	A	A	A	A	A	A	A	A
Steam (over 450°F)	A	A	A	A	C	C	NS	NS	NS	NS	NS	A	A	A	A	A	A
Steam (Low-med Pressure)	A	A	A	A	A	C	A	A	A	A	-	A	A	A	-	-	-
Steam (High Pressure)	NS	A	A	A	C	NS	-	-	-	-	-	A	A	A	-	-	-
Stearic Acid	A	A	A	A	C	A	A	A	A	A	A	A	A	A	A	A	A
Stoddard Solvent	A	A	A	A	NS	C	A	A	A	A	A	A	A	A	-	-	-
Styrene	NS	NS	NS	NS	NS	NS	A	A	A	A	C	A	A	A	-	-	-
Sulfite Liquors	A	A	A	A	C	C	A	A	A	A	-	A	C	C	-	-	-
Sulfur (Molten)	NS	NS	NS	NS	NS	NS	A	A	A	A	-	A	A	A	A	A	A
Sulfur Dioxide	NS	NS	C	NS	NS	NS	A	A	A	A	A	A	A	A	A	A	A
Sulfuric Acid (<20%)	NS	NS	NS	NS	NS	NS	A	A	A	A	A	NS	NS	NS	NS	NS	NS
Sulfuric Acid (20-60%)	NS	NS	NS	NS	NS	NS	A	A	NS	A	A	-	-	-	NS	NS	NS
Sulfuric Acid (60-80%)	NS	NS	NS	NS	NS	NS	A	C	NS	A	A	-	-	-	NS	NS	NS
Sulfuric Acid (>80%)	NS	NS	NS	NS	NS	NS	C	NS	NS	A	A	-	-	-	NS	NS	NS
Fuming Sulfuric Acid, Oleum	NS	NS	NS	NS	NS	NS	A	NS	NS	A	A	NS	NS	NS	-	-	-
Tar	A	A	A	A	NS	NS	A	A	A	A	-	A	A	A	A	A	A
Tartaric Acid	A	A	A	A	A	A	A	A	A	A	A	A	A	A	A	A	A
Tetrachloroethane	NS	NS	NS	NS	NS	NS	A	A	A	A	A	A	A	A	C	C	C

Technical Information - Chemical Resistance

Chemical Resistance - Non-Metallic Gaskets

The following information is a general guide only for the selection of a suitable gasket material as there are unlimited combinations of fluid, pressure, and temperature conditions.
 A = Acceptable C = Caution-Dependent on Conditions NS = Not Suitable - = No Data Available

Fluid	Durlon® Compressed Non-Asbestos Sheet						Durlon® PTFE					Durlon® Flexible Graphite			Durlon® HT1000®		
	5000 7900 7910 7925 7950	8300 8900	8400	8500	8600	8700	9000 9000N 9002	9200	9400	Virgin Joint Sealant 9600	9645	FGS95	CFG FGL316 FGM316	FGT316	S90	L316	T316
Tetrahydrofuran (THF)	NS	NS	NS	NS	NS	NS	A	A	A	A	A	A	A	A	-	-	-
Toluene	NS	NS	NS	NS	NS	C	A	A	A	A	A	A	A	A	A	A	A
Transformer Oil	A	A	A	A	NS	A	A	A	A	A	A	A	A	A	A	A	A
Transmission Fluid	A	A	A	A	NS	A	A	A	A	A	A	A	A	A	A	A	A
Trichloroethane	NS	NS	NS	NS	NS	NS	A	A	A	A	A	A	A	A	C	C	C
Trichloroethylene	NS	NS	NS	NS	NS	NS	A	A	A	A	A	A	A	A	C	C	C
Triethanolamine	A	A	A	A	NS	NS	A	A	A	A	A	C	C	C	A	C	C
Turpentine	A	A	A	A	NS	NS	A	A	A	A	A	A	A	A	A	A	A
Urea	A	A	A	A	NS	A	A	A	A	A	A	A	A	A	A	A	A
Varsol	A	A	A	A	NS	NS	A	A	A	A	-	A	A	A	A	A	A
Vegetable Oil	A	A	A	A	NS	NS	A	A	A	A	A	A	A	A	A	A	A
Vinegar	A	A	A	A	A	A	A	A	A	A	A	A	A	A	A	A	A
Vinyl Acetate	NS	NS	NS	NS	NS	NS	A	A	A	A	C	A	A	A	A	A	A
Vinyl Chloride	NS	NS	NS	NS	NS	NS	A	A	A	A	A	A	A	A	-	-	-
Water	A	A	A	A	A	A	A	A	A	A	-	A	A	A	A	A	A
Water Mine Acid	C	C	C	C	NS	NS	A	A	-	A	A	-	-	-	-	-	-
Water Deionized	A	A	A	A	A	A	A	A	A	A	A	-	-	-	-	-	-
Water Sea	A	A	A	A	A	A	A	A	A	A	A	A	A	A	A	A	A
Whiskey	A	A	A	A	A	A	A	A	A	A	A	A	A	A	A	A	A
White Sulfate Liquor	A	A	A	A	NS	A	A	A	A	A	-	A	A	A	A	A	A
White Spirit	A	A	A	A	NS	C	A	A	A	A	-	A	A	A	-	-	-
Wines	A	A	A	A	A	A	A	A	A	A	A	A	A	A	A	A	A
Xylene	NS	NS	NS	NS	NS	NS	A	A	A	A	A	A	A	A	A	A	A
Zinc Chloride	A	A	A	A	A	A	A	A	A	A	A	A	A	A	-	-	-
Zinc Nitrate	A	A	A	A	A	A	A	A	C	A	-	C	C	C	-	-	-
Zinc Sulfate	A	A	A	A	A	A	A	A	A	A	A	A	A	A	-	-	-

The information provided in the Chemical Resistant Charts (pages 64-71) is a general guide for the selection of a suitable gasket material. The substances listed are evaluated for their effect on the gasket materials at ambient temperature -40°F/C to 38°C (100°F) unless stated otherwise. For unusual conditions of fluid concentrates, internal pressures or temperature consult our technical support team. This evaluation is based on experience and laboratory or field tests. No guarantee can be given as to the actual performance experienced by the end user. There are several fluids used in food which can be sealed by SBR, however due to flavor pickup, we have marked these products "Caution." These chemical resistance charts supersede and obsolete all previously issued charts.

While significant efforts have been made to ensure the accuracy of this information, we disclaim responsibility for errors that have occurred after the printing of this manual. Specifications may undergo changes without prior notice. For the latest and most accurate information, kindly visit www.durlon.com/resources/technical-references/

Gasket Dimensions ASME B16.21 - Cut Gaskets & CFG's

CLASS 150#														
B16.5 (Inches)		Ring	Full Face				B16.5 (mm)		Ring	Full Face				
Pipe Size	Gasket I.D.	Gasket O.D.	Gasket O.D.	Bolt Circle	Bolt Hole Qty.	Bolt Hole Dia.	Pipe Size DN (mm)	Gasket I.D.	Gasket O.D.	Gasket O.D.	Bolt Circle	Bolt Hole Qty.	Bolt Hole Dia.	
0.5	0.84	1.88	3.50	2.38	4	0.63	15	21.3	47.8	88.9	60.5	4	16.0	
0.75	1.06	2.25	3.88	2.75	4	0.63	20	26.9	57.2	98.6	69.9	4	16.0	
1	1.31	2.62	4.25	3.13	4	0.63	25	33.3	66.5	108.0	79.5	4	16.0	
1.25	1.66	3.00	4.63	3.50	4	0.63	32	42.2	76.2	117.6	88.9	4	16.0	
1.5	1.91	3.38	5.00	3.88	4	0.63	40	48.5	85.9	127.0	98.6	4	16.0	
2	2.38	4.12	6.00	4.75	4	0.75	50	60.5	104.6	152.4	120.7	4	19.1	
2.5	2.88	4.88	7.00	5.50	4	0.75	65	73.2	124.0	177.8	139.7	4	19.1	
3	3.50	5.38	7.50	6.00	4	0.75	80	88.9	136.7	190.5	152.4	4	19.1	
3.5	4.00	6.38	8.50	7.00	8	0.75	90	101.6	162.1	215.9	177.8	8	19.1	
4	4.50	6.88	9.00	7.50	8	0.75	100	114.3	174.8	228.6	190.5	8	19.1	
5	5.56	7.75	10.00	8.50	8	0.88	125	141.2	196.9	254.0	215.9	8	22.4	
6	6.62	8.75	11.00	9.50	8	0.88	150	168.1	222.3	279.4	241.3	8	22.4	
8	8.62	11.00	13.50	11.75	8	0.88	200	218.9	279.4	342.9	298.5	8	22.4	
10	10.75	13.38	16.00	14.25	12	1.00	250	273.1	339.9	406.4	362.0	12	25.4	
12	12.75	16.13	19.00	17.00	12	1.00	300	323.9	409.7	482.6	431.8	12	25.4	
14	14.00	17.75	21.00	18.75	12	1.13	350	355.6	450.9	533.4	476.3	12	28.7	
16	16.00	20.25	23.50	21.25	16	1.13	400	406.4	514.4	596.9	539.8	16	28.7	
18	18.00	21.62	25.00	22.75	16	1.25	450	457.2	549.1	635.0	577.9	16	31.8	
20	20.00	23.88	27.50	25.00	20	1.25	500	508.0	606.6	698.5	635.0	20	31.8	
22	22.00	26.00	29.50	27.25	20	1.38	550	558.8	660.4	749.3	692.2	20	35.1	
24	24.00	28.25	32.00	29.50	20	1.38	600	609.6	717.6	812.8	749.3	20	35.1	

CLASS 300#					
B16.5 (Inches)		Ring	B16.5 (Inches)		
Pipe Size	Gasket I.D.	Gasket O.D.	Pipe Size	Gasket I.D.	Gasket O.D.
0.5	0.84	2.12	6	6.62	9.88
0.75	1.06	2.62	8	8.62	12.12
1	1.31	2.88	10	10.75	14.25
1.25	1.66	3.25	12	12.75	16.62
1.5	1.91	3.75	14	14.00	19.12
2	2.38	4.38	16	16.00	21.25
2.5	2.88	5.12	18	18.00	23.50
3	3.50	5.88	20	20.00	25.75
3.5	4.00	6.50	22	22.00	27.75
4	4.50	7.12	24	24.00	30.50
5	5.56	8.50			

CLASS 300#					
B16.5 (mm)		Ring	B16.5 (mm)		
Pipe Size DN (mm)	Gasket I.D.	Gasket O.D.	Pipe Size DN (mm)	Gasket I.D.	Gasket O.D.
15	21.3	53.8	150	168.1	251.0
20	26.9	66.5	200	218.9	307.8
25	33.3	73.2	250	273.1	362.0
32	42.2	82.6	300	323.9	422.1
40	48.5	95.3	350	355.6	485.6
50	60.5	111.3	400	406.4	539.8
65	73.2	130.0	450	457.2	596.9
80	88.9	149.4	500	508.0	654.1
90	101.6	165.1	550	558.8	704.9
100	114.3	180.8	600	609.6	774.7
125	141.2	215.9			

Gasket Dimensions - Durtec® - Units in inches (millimeters)

NPS	DN	I.D.	Gasket O.D.							
			Pressure Class							
			150	300	400	600	900	1500	2500	
½"	15	0.91 (23.1)	1.88 (47.8)	2.13 (54.1)	2.13 (54.1)	2.13 (54.1)	2.13 (54.1)	2.50 (63.5)	2.50 (63.5)	2.75 (69.9)
¾"	20	1.13 (28.7)	2.25 (57.2)	2.63 (66.8)	2.63 (66.8)	2.63 (66.8)	2.63 (66.8)	2.75 (69.9)	2.75 (69.9)	3.00 (76.2)
1"	25	1.44 (36.6)	2.63 (66.8)	2.88 (73.2)	2.88 (73.2)	2.88 (73.2)	2.88 (73.2)	3.13 (79.5)	3.13 (79.5)	3.38 (85.9)
1 ¼"	32	1.75 (44.5)	3.00 (76.2)	3.25 (82.6)	3.25 (82.6)	3.25 (82.6)	3.25 (82.6)	3.50 (88.9)	3.50 (88.9)	4.13 (104.9)
1 ½"	40	2.06 (52.3)	3.38 (85.9)	3.75 (95.3)	3.75 (95.3)	3.75 (95.3)	3.75 (95.3)	3.88 (98.6)	3.88 (98.6)	4.63 (117.6)
2"	50	2.75 (69.9)	4.13 (104.9)	4.38 (111.1)	4.38 (111.3)	4.38 (111.3)	4.38 (111.3)	5.63 (143.0)	5.63 (143.0)	5.75 (146.1)
2 ½"	65	3.25 (82.6)	4.88 (124.0)	5.13 (130.3)	5.13 (130.3)	5.13 (130.3)	5.13 (130.3)	6.50 (165.1)	6.50 (165.1)	6.63 (168.4)
3"	80	3.87 (98.3)	5.38 (136.7)	5.88 (149.4)	5.88 (149.4)	5.88 (149.4)	5.88 (149.4)	6.63 (168.4)	6.88 (174.8)	7.75 (196.9)
3 ½"	90	4.37 (111.0)	6.37 (161.9)	6.50 (165.1)	6.37 (161.9)	6.37 (161.9)	6.37 (161.9)	7.50 (190.5)	7.38 (187.5)	-
4"	100	4.87 (123.7)	6.88 (174.8)	7.13 (181.0)	7.00 (177.8)	7.63 (193.8)	8.13 (206.5)	8.13 (206.5)	8.25 (209.6)	9.25 (235.0)
5"	125	5.94 (150.9)	7.75 (196.9)	8.50 (215.9)	8.38 (212.9)	9.50 (241.3)	9.75 (247.7)	9.75 (247.7)	10.00 (254.0)	11.00 (279.4)
6"	150	7.00 (177.8)	8.75 (222.3)	9.88 (251.0)	9.75 (247.7)	10.50 (266.7)	11.38 (289.1)	11.38 (289.1)	11.13 (282.7)	12.50 (317.5)
8"	200	9.00 (228.6)	11.00 (279.4)	12.13 (308.1)	12.00 (304.8)	12.63 (320.8)	14.13 (358.9)	14.13 (358.9)	13.88 (352.6)	15.25 (387.4)
10"	250	11.13 (282.7)	13.38 (339.9)	14.25 (362.0)	14.13 (358.9)	15.75 (400.1)	17.13 (435.1)	17.13 (435.1)	17.13 (435.1)	18.75 (476.3)
12"	300	13.37 (339.6)	16.13 (409.7)	16.63 (422.4)	16.5 (419.1)	18.00 (457.2)	19.63 (498.6)	19.63 (498.6)	20.50 (520.7)	21.63 (549.4)
14"	350	14.63 (371.6)	17.75 (450.9)	19.13 (485.9)	19.00 (482.6)	19.38 (492.3)	20.50 (520.7)	20.50 (520.7)	22.75 (577.9)	-
16"	400	16.63 (422.4)	20.25 (514.4)	21.25 (539.8)	21.13 (536.7)	22.25 (565.2)	22.63 (574.8)	22.63 (574.8)	25.25 (641.4)	-
18"	450	18.87 (479.3)	21.63 (549.4)	23.50 (596.9)	23.38 (593.9)	24.13 (612.9)	25.13 (638.3)	25.13 (638.3)	27.75 (704.9)	-
20"	500	20.87 (530.1)	23.88 (606.6)	25.75 (654.1)	25.50 (647.7)	26.88 (682.8)	27.50 (698.5)	27.50 (698.5)	29.75 (755.7)	-
22"	550	23.12 (587.2)	26.00 (660.4)	27.75 (704.9)	27.63 (701.8)	28.88 (733.6)	-	-	-	-
24"	600	24.87 (631.7)	28.25 (717.6)	30.50 (774.7)	30.25 (768.4)	31.13 (790.7)	33.00 (838.2)	33.00 (838.2)	35.50 (901.7)	-

Gasket Dimensions - Spiral Wound Gaskets - Units in inches

Flange Size (NPS)	Windings OD		Durlon® SWG Style By Pressure Class*														Durlon® SWG Style DRI By Pressure Class**						
	Class 150, 300, 400, 600	Class 900, 1500, 2500	150		300		400		600		900		1500		2500		150	300	400	600	900	1500	2500
			ID	OD	ID	OD	ID	OD	ID	OD	ID	OD	ID	OD	ID	OD	ID	ID	ID	ID	ID	ID	ID
½"	1.25	1.25	0.75	1.88	0.75	2.13	-	-	0.75	2.13	-	-	0.75	2.50	0.75	2.75	0.56	0.56	-	0.56	-	0.56	0.56
¾"	1.56	1.56	1.00	2.25	1.00	2.63	-	-	1.00	2.63	-	-	1.00	2.75	1.00	3.00	0.81	0.81	-	0.81	-	0.81	0.81
1"	1.88	1.88	1.25	2.63	1.25	2.88	-	-	1.25	2.88	-	-	1.25	3.13	1.25	3.38	1.06	1.06	-	1.06	-	1.06	1.06
1 ¼"	2.38	2.38	1.88	3.00	1.88	3.25	-	-	1.88	3.25	-	-	1.56	3.50	1.56	4.13	1.50	1.50	-	1.50	-	1.31	1.31
1 ½"	2.75	2.75	2.13	3.38	2.13	3.75	-	-	2.13	3.75	-	-	1.88	3.88	1.88	4.63	1.75	1.75	-	1.75	-	1.63	1.63
2"	3.38	3.38	2.75	4.13	2.75	4.38	-	-	2.75	4.38	-	-	2.31	5.63	2.31	5.75	2.19	2.19	-	2.19	-	2.06	2.06
2 ½"	3.88	3.88	3.25	4.88	3.25	5.13	-	-	3.25	5.13	-	-	2.75	6.50	2.75	6.63	2.62	2.62	-	2.62	-	2.50	2.50
3"	4.75	4.75	4.00	5.38	4.00	5.88	-	-	4.00	5.88	3.75	6.63	3.63	6.88	3.63	7.75	3.19	3.19	-	3.19	3.10	3.10	3.10
3 ½"	5.25	-	4.50	6.38	4.50	6.50	-	-	4.13	6.38	-	-	-	-	-	-	3.98	3.98	-	3.60	-	-	-
4"	5.88	5.88	5.00	6.88	5.00	7.13	4.75	7.00	4.75	7.63	4.75	8.13	4.63	8.25	4.63	9.25	4.19	4.19	4.04	4.04	4.04	3.85	3.85
5"	7.00	7.00	6.13	7.75	6.13	8.50	5.81	8.38	5.81	9.50	5.81	9.75	5.63	10.00	5.63	11.00	5.19	5.19	5.05	5.05	5.05	4.90	4.90
6"	8.25	8.25	7.19	8.75	7.19	9.88	6.88	9.75	6.88	10.50	6.88	11.38	6.75	11.13	6.75	12.50	6.19	6.19	6.10	6.10	6.10	5.80	5.80
8"	10.38	10.13	9.19	11.00	9.19	12.13	8.88	12.00	8.88	12.63	8.75	14.13	8.50	13.88	8.50	15.25	8.50	8.50	8.10	8.10	7.75	7.75	7.75
10"	12.50	12.25	11.31	13.38	11.31	14.25	10.81	14.13	10.81	15.75	10.88	17.13	10.50	17.13	10.63	18.75	10.56	10.56	10.05	10.05	9.69	9.69	9.69
12"	14.75	14.50	13.38	16.13	13.38	16.63	12.88	16.50	12.88	18.00	12.75	19.63	12.75	20.50	12.50	21.63	12.50	12.50	12.10	12.10	11.50	11.50	11.50
14"	16.00	15.75	14.63	17.75	14.63	19.13	14.25	19.00	14.25	19.38	14.00	20.50	14.25	22.75	-	-	13.75	13.75	13.50	13.50	12.63	12.63	-
16"	18.25	18.00	16.63	20.25	16.63	21.25	16.25	21.13	16.25	22.25	16.25	22.63	16.00	25.25	-	-	15.75	15.75	15.35	15.35	14.75	14.50	-
18"	20.75	20.50	18.69	21.63	18.69	23.50	18.50	23.38	18.50	24.13	18.25	25.13	18.25	27.75	-	-	17.69	17.69	17.25	17.25	16.75	16.75	-
20"	22.75	22.50	20.69	23.88	20.69	25.75	20.50	25.50	20.50	26.88	20.50	27.50	20.25	29.75	-	-	19.69	19.69	19.25	19.25	19.00	18.75	-
22"	24.63	-	23.38	26.00	22.75	27.75	22.75	27.63	22.75	28.88	-	-	-	-	-	-	22.38	21.75	21.50	21.50	-	-	-
24"	27.00	26.75	24.75	28.25	24.75	30.50	24.75	30.25	24.75	31.13	24.75	33.00	24.25	35.50	-	-	23.75	23.75	23.25	23.25	23.25	22.75	-

* Windings ID/Outer Ring OD ** Inner Ring ID

Notes:

- Inner rings (style DRI) are required for all PTFE filled gaskets; for "all other" filler materials NPS 24" Class 900 gaskets, NPS 12" - 24" Class 1500 gaskets, and NPS 4" - 12" Class 2500 gaskets (see shaded areas on chart).
- The dimensions for Class 300, Class 400, & Class 600 gaskets in NPS ½" - 3" sizes are the same and are designated as dual Class 300/400/600 in these sizes and shall be marked accordingly.
- The dimensions for Class 900 & 1500 gaskets in NPS ½" - 2 ½" are the same and are designated as dual Class 900/1500 in these sizes and shall be marked accordingly.
- Where there are no sizes listed for Class 400 flanges in NPS ½" through NPS 3 ½" (use Class 600); Class 900 flanges in NPS ½" through NPS 2 ½" (use Class 1500).
- There are no flanges in NPS 3 ½" Class 900 and Class 1500; or Class 2500 flanges in NPS 3 ½" or NPS 14" and larger.
- Inner rings (style DRI) are the default selling condition for graphite filled gaskets. If inner rings are not required, "no inner ring" (style DR) must be specified for graphite or mica-graphite filled gaskets at time of order. Adapted from ASME B16.20.
- Adapted from B16.20.

Gasket Dimensions - Spiral Wound Gaskets - Units in millimeters

Flange Size (NPS)	Windings OD		Durlon® SWG Style By Pressure Class*												Durlon® SWG Style DRI By Pressure Class**								
	Class 150, 300, 400, 600	Class 900, 1500, 2500	150		300		400		600		900		1500		2500		150	300	400	600	900	1500	2500
			ID	OD	ID	OD	ID	OD	ID	OD	ID	OD	ID	OD	ID	OD	ID	OD	ID	ID	ID	ID	ID
½"	31.8	31.8	19.1	47.8	19.1	54.1	-	-	19.1	54.1	-	-	19.1	63.5	19.1	69.9	14.2	14.2	-	14.2	-	14.2	14.2
¾"	39.6	39.6	25.4	57.2	25.4	66.8	-	-	25.4	66.8	-	-	25.4	69.9	25.4	76.2	20.6	20.6	-	20.6	-	20.6	20.6
1"	47.8	47.8	31.8	66.8	31.8	73.2	-	-	31.8	73.2	-	-	31.8	79.5	31.8	85.9	26.9	26.9	-	26.9	-	26.9	26.9
1 ¼"	60.5	60.5	47.8	76.2	47.8	82.6	-	-	47.8	82.6	-	-	39.6	88.9	39.6	104.9	38.1	38.1	-	38.1	-	33.3	33.3
1 ½"	69.9	69.9	54.1	85.9	54.1	95.3	-	-	54.1	95.3	-	-	47.8	98.6	47.8	117.6	44.5	44.5	-	44.5	-	41.4	41.4
2"	85.9	85.9	69.9	104.9	69.9	111.3	-	-	69.9	111.3	-	-	58.7	143.0	58.7	146.1	55.6	55.6	-	55.6	-	52.3	52.3
2 ½"	98.6	98.6	82.6	124.0	82.6	130.3	-	-	82.6	130.3	-	-	69.9	165.1	69.9	168.4	66.5	66.5	-	66.5	-	63.5	63.5
3"	120.7	120.7	101.6	136.7	101.6	149.4	-	-	101.6	149.4	95.3	168.4	92.2	174.8	92.2	196.9	81.0	81.0	-	81.0	78.7	78.7	78.7
3 ½"	133.4	-	114.3	161.9	114.3	165.1	-	-	104.8	161.9	-	-	-	-	-	-	66.5	66.5	-	91.4	-	-	-
4"	149.4	149.4	127.0	174.8	127.0	181.1	120.7	177.8	120.7	193.8	120.7	206.5	117.6	209.6	117.6	235.0	106.4	106.4	102.6	102.6	102.6	97.8	97.8
5"	177.8	177.8	155.7	196.9	155.7	215.9	147.6	212.9	147.6	241.3	147.6	247.7	143.0	254.0	143.0	279.4	131.8	131.8	128.3	128.3	128.3	124.5	124.5
6"	209.6	209.6	182.6	222.3	182.6	251.0	174.8	247.7	174.8	266.7	174.8	289.1	171.5	282.7	171.5	317.5	157.2	157.2	154.9	154.9	154.9	147.3	147.3
8"	263.7	257.3	233.4	279.4	233.4	308.1	225.6	304.8	225.6	320.8	222.3	358.9	215.9	352.6	215.9	387.4	215.9	215.9	205.7	205.7	196.9	196.9	196.9
10"	317.5	311.2	287.3	339.9	287.3	362.0	274.6	358.9	274.6	400.1	276.4	435.1	266.7	435.1	270.0	476.3	268.2	268.2	255.3	255.3	246.1	246.1	246.1
12"	374.7	368.3	339.9	409.7	339.9	422.4	327.2	419.1	327.2	457.2	323.9	498.6	323.9	520.7	317.5	549.4	317.5	317.5	307.3	307.3	292.1	292.1	292.1
14"	406.4	400.1	371.6	450.9	371.6	485.9	362.0	482.6	362.0	492.3	355.6	520.7	362.0	577.9	-	-	349.3	349.3	342.9	342.9	320.8	320.8	-
16"	463.6	457.2	422.4	514.4	422.4	539.8	412.8	536.7	412.8	565.2	412.8	574.8	406.4	641.4	-	-	400.1	400.1	389.9	389.9	374.7	368.3	-
18"	527.1	520.7	474.7	549.4	474.7	596.9	469.9	593.9	469.9	612.9	463.6	638.3	463.6	704.9	-	-	449.3	449.3	438.2	438.2	425.5	425.5	-
20"	577.9	571.5	525.5	606.6	525.5	654.1	520.7	647.7	520.7	682.8	520.7	698.5	514.4	755.7	-	-	500.1	500.1	489.0	489.0	482.6	476.3	-
22"	625.5	-	593.8	660.4	577.9	704.9	577.9	701.8	577.9	733.6	-	-	-	-	-	-	568.4	552.5	546.2	546.2	-	-	-
24"	685.8	679.5	628.7	717.6	628.7	774.7	628.7	768.4	628.7	790.7	628.7	838.2	616.0	901.7	-	-	603.3	603.3	590.6	590.6	590.6	577.9	-

* Windings ID/Outer Ring OD ** Inner Ring ID

- Notes:**
- Inner rings (style DRI) are required for all PTFE filled gaskets; for "all other" filler materials NPS 24" Class 900 gaskets, NPS 12" - 24" Class 1500 gaskets, and NPS 4" - 12" Class 2500 gaskets (see shaded areas on chart ).
 - The dimensions for Class 300, Class 400, & Class 600 gaskets in NPS ½" - 3" sizes are the same and are designated as dual Class 300/400/600 in these sizes and shall be marked accordingly.
 - The dimensions for Class 900 & 1500 gaskets in NPS ½" - 2 ½" are the same and are designated as dual Class 900/1500 in these sizes and shall be marked accordingly.
 - Where there are no sizes listed for Class 400 flanges in NPS ½" through NPS ½" (use Class 600); Class 900 flanges in NPS ½" through NPS 2 ½" (use Class 1500).
 - There are no flanges in NPS 3 ½" Class 900 and Class 1500; or Class 2500 flanges in NPS 3 ½" or NPS 14" and larger.
 - Inner rings (style DRI) are the default selling condition for graphite filled gaskets. If inner rings are not required, "no inner ring" (style DR) must be specified for graphite or mica-graphite filled gaskets at time of order. Adapted from ASME B16.20.
 - Adapted from B16.20.

Gasket Dimensions - Kammprofile - Units in inches (millimeters)

NPS	DN	Serrated Metal Ring (mm)		Centering Ring Outside Diameter						
		ASME, BS & MSS		Pressure Class						
		ID	OD	150	300	400	600	900	1500	2500
½"	15	0.91 (23.1)	1.31 (33.3)	1.88 (47.8)	2.13 (54.1)	-	2.13 (54.1)	-	2.50 (63.5)	2.75 (69.9)
¾"	20	1.13 (28.7)	1.56 (39.6)	2.25 (57.2)	2.63 (66.8)	-	2.63 (66.8)	-	2.75 (69.9)	3.00 (76.2)
1"	25	1.44 (36.6)	1.87 (47.5)	2.63 (66.8)	2.88 (73.2)	-	2.88 (73.2)	-	3.13 (79.5)	3.38 (85.9)
1 ¼"	32	1.75 (44.5)	2.37 (60.2)	3.00 (76.2)	3.25 (82.6)	-	3.25 (82.6)	-	3.50 (88.9)	4.13 (104.9)
1 ½"	40	2.06 (52.3)	2.75 (69.9)	3.38 (85.9)	3.75 (95.3)	-	3.75 (95.3)	-	3.88 (98.6)	4.63 (117.6)
2"	50	2.75 (69.9)	3.50 (88.9)	4.13 (104.9)	4.38 (111.1)	-	4.38 (111.3)	-	5.63 (143.0)	5.75 (146.1)
2 ½"	65	3.25 (82.6)	4.00 (101.6)	4.88 (124.0)	5.13 (130.3)	-	5.13 (130.3)	-	6.50 (165.1)	6.63 (168.4)
3"	80	3.87 (98.3)	4.87 (123.7)	5.38 (136.7)	5.88 (149.4)	-	5.88 (149.4)	6.63 (168.4)	6.88 (174.8)	7.75 (196.9)
3 ½"	90	4.37 (111.0)	5.37 (136.5)	6.37 (161.9)	6.50 (165.1)	-	6.37 (161.9)	-	-	-
4"	100	4.87 (123.7)	6.06 (153.9)	6.88 (174.8)	7.13 (181.0)	7.00 (177.8)	7.63 (193.8)	8.13 (206.5)	8.25 (209.6)	9.25 (235.0)
5"	125	5.94 (150.9)	7.19 (182.6)	7.75 (196.9)	8.50 (215.9)	8.38 (212.9)	9.50 (241.3)	9.75 (247.7)	10.00 (254.0)	11.00 (279.4)
6"	150	7.00 (177.8)	8.37 (212.6)	8.75 (222.3)	9.88 (251.0)	9.75 (247.7)	10.50 (266.7)	11.38 (289.1)	11.13 (282.7)	12.50 (317.5)
8"	200	9.00 (228.6)	10.50 (266.7)	11.00 (279.4)	12.13 (308.1)	12.00 (304.8)	12.63 (320.8)	14.13 (358.9)	13.88 (352.6)	15.25 (387.4)
10"	250	11.13 (282.7)	12.63 (320.8)	13.38 (339.9)	14.25 (362.0)	14.13 (358.9)	15.75 (400.1)	17.13 (435.1)	17.13 (435.1)	18.75 (476.3)
12"	300	13.37 (339.6)	14.87 (377.7)	16.13 (409.7)	16.63 (422.4)	16.5 (419.1)	18.00 (457.2)	19.63 (498.6)	20.50 (520.7)	21.63 (549.4)
14"	350	14.63 (371.6)	16.13 (409.7)	17.75 (450.9)	19.13 (485.9)	19.00 (482.6)	19.38 (492.3)	20.50 (520.7)	22.75 (577.9)	-
16"	400	16.63 (422.4)	18.37 (466.6)	20.25 (514.4)	21.25 (539.8)	21.13 (536.7)	22.25 (565.2)	22.63 (574.8)	25.25 (641.4)	-
18"	450	18.87 (479.3)	20.87 (530.1)	21.63 (549.4)	23.50 (596.9)	23.38 (593.9)	24.13 (612.9)	25.13 (638.3)	27.75 (704.9)	-
20"	500	20.87 (530.1)	22.87 (580.9)	23.88 (606.6)	25.75 (654.1)	25.50 (647.7)	26.88 (682.8)	27.50 (698.5)	29.75 (755.7)	-
22"	550	23.12 (587.2)	25.12 (638.0)	26.00 (661.4)	27.75 (704.9)	27.63 (701.8)	28.88 (733.6)	-	-	-
24"	600	24.87 (631.7)	26.87 (682.5)	28.25 (717.6)	30.50 (774.7)	30.25 (768.4)	31.13 (790.7)	33.00 (838.2)	35.50 (901.7)	-

Notes:

- The dimensions for Class 300, Class 400, & Class 600 gaskets in NPS ½" - 3" sizes are the same and are designated as dual Class 300/400/600 in these sizes and shall be marked accordingly.
- The dimensions for Class 900 & 1500 gaskets in NPS ½" - 2 ½" are the same and are designated as dual Class 900/1500 in these sizes and shall be marked accordingly.
- Where there are no sizes listed for Class 400 flanges in NPS ½" through NPS 3 ½" (use Class 600); Class 900 flanges in NPS ½" through NPS 2 ½" (use Class 1500).
- There are no flanges in NPS 3 ½" Class 900 and Class 1500; or Class 2500 flanges in NPS 3 ½" or NPS 14 and larger.
- Adapted from B16.20.

Custom Capabilities

Durlon® prides itself in offering high-quality fabricated sealing components with high-precision and fast turnaround capabilities. Our state-of-the-art research and development facilities are geared to meet the ever-changing demands required in today's variety of service conditions. This is the reason why we use some of the most modern and sophisticated processes to meet your custom needs.

The following list of our custom capabilities is why we invest back into our companies to bring you the very best in sealing solution technology.

FLASH CUTTER

We use modern digital flatbed cutting machines that can cut gaskets with precision, accuracy, and less start-up time, resulting in improved quality of the finished parts. Our machines work with various styles of sheet gasket materials; single, multi-layered, and in thicknesses up to 8mm (5/16").

With our primary CNC controlled cutting table, we can quickly, and precisely cut almost any custom shape with no minimum order requirements. Our equipment eliminates the need to have dies made, which is costly and comes with long lead times. We package all cut gaskets with lot traceability identification tags in compliance with our ISO Quality System.

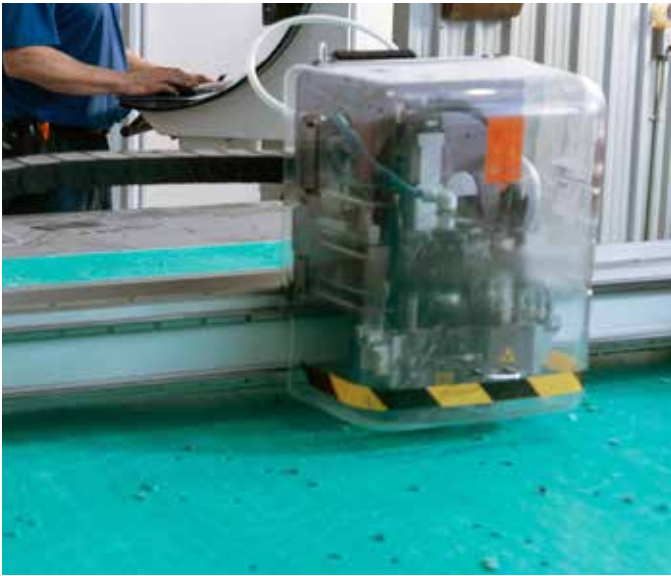

PTFE WELDING

Some applications used in designs for chemical reactors, food and beverage vessels, and heat exchangers, require PTFE gaskets larger than 1,524mm (60") in diameter. Many fabricators simply use a traditional dovetail design, joining several segments together to form the finished large gasket. Sometimes these dovetails are wrapped in additional material and may be covered in special form-in-place liquid sealants, in order to seal the leak paths created from this design. This approach may lead to leaks and can make the gasket very hard to install.

By using segments cut from our digital flatbed cutting machine, we are able to solve dovetail design problems. We can bond segments together, creating a superior performing gasket with our proprietary welding procedure, and equipment designed by our in-house mechanical engineering experts. Our finished Ring Type or Full Face gaskets can be made with cross-sections up to 229mm (9") wide, giving our customers the reassurance that their large diameter sealing requirements will perform as expected.



LASER METAL CUTTING MACHINE

This fiber sheet laser cutter is used for cutting thin sheet metal like carbon steel, stainless steel, brass, aluminum, copper, and various other metals. With power ranges from 1000watts – 3000watts, our laser cutting machine can cut thin metal sheets quickly and accurately and up to 25/32", and has passed the CE/FDA/ETL certification for safe and effective use.



CNC LATHE CUTTING

The lathe cutting process produces an extremely precise and accurately cut, finished gasket because it follows the same stringent quality control parameters as our large sheet manufacturing process. This process is efficient and cost effective when producing high volume ring, and step ring gaskets, and highly recommended for smaller PTFE billets.

Our lathe-cut PTFE gaskets are produced using only the best quality billets of Durlon® 9000, 9000N, 9200, and 9400 – some of the most highly recommended PTFE gasket material approved for use with a number of important industrial chemicals.



SWG WINDING MACHINE

Ensures repeatability and consistent quality
 Quick turnaround on Style D, DR and DRI gaskets
 Custom thicknesses available for special OEM equipment
 Sizes from 1/2" ID to 157" OD



CUSTOM METALLURGY

Due to increasing demand in high performance metallurgy requests for both critical and chemical applications, we stock numerous alloys for both standard and custom gasket requirements. Our metal inventory includes: 304SS, 316L, 317SS, 321SS, 347SS, Monel 400, Duplex 2205, Super Duplex 2507, Alloy 20, Hastelloy C276, Inconel 600/750/825, Titanium, and Zirconium (Zr702).



CUSTOM FABRICATED METALLIC GASKETS

We custom manufacture spiral wound and Kammprofile gaskets to customer dimensional and material requirements. Both gasket styles can be manufactured with common pass bar styles, typically used in heat exchangers up to 2,642mm (104") in diameter. Using sophisticated semi-automatic digital equipment, we can ensure that dimensional stability and assembly precision are met on every gasket produced. Combined with full internal traceability on raw materials, we provide custom fabricated metallic gaskets that can be depended on for the entire lifespan of the installation.



KAMMPROFILE/DURTEC GASKETS

Size range 1/2" – 157"
 Parallel and convex cores
 Floating and integral CR's
 SWG Centering Rings
 SWG Inner Rings

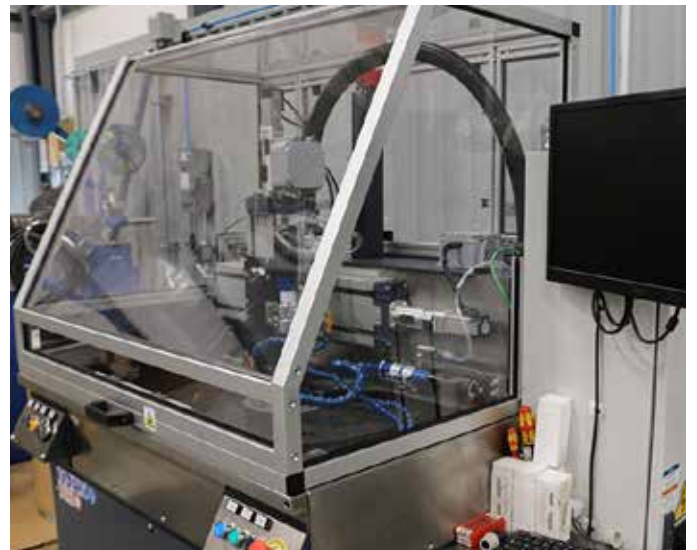

WATER JET CUTTING

This "State of the Art" water jet cutting table with high intensity pump and 5 axis cutting head, allows 3D cutting for up to 6'6" x 10' sheets of metal, CNA, and PTFE. With this new addition to our manufacturing facility, we can cut all metal gasket components from SWG's to Kammprofiles, with cutting speeds of 400 IPM speed range and +/- 0.005" accuracy. This new technology allows us to offer high precision products with quick turn-around times, on both standard and custom gaskets in metallurgies that can range from 304SS to Zirconium.

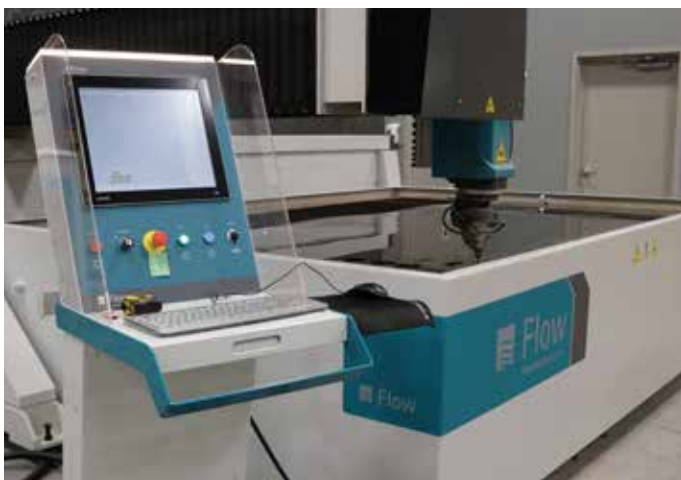

HYDRAULIC BENDER

Hydraulic bending allows us the ability to bend rings for both spiral wound components and Kammprofile gaskets utilizing the flat bar strip from either slit coils or strips cut from sheets on our water jet table. This allows us to be more cost effective when manufacturing large OD gaskets because there is no center drop from the material, which can increase the gasket's cost. We have the ability to bend gasket OD's from 8" - 167" with 1/4" through 2" cross sections.



LASER MARKING

We utilize a Class 1 fiber laser to mark all of our metal gasket components for easy identification and traceability. Not only does it mark the size and class of the gasket, but the heat #, PO# and even QR Code can be added if required.

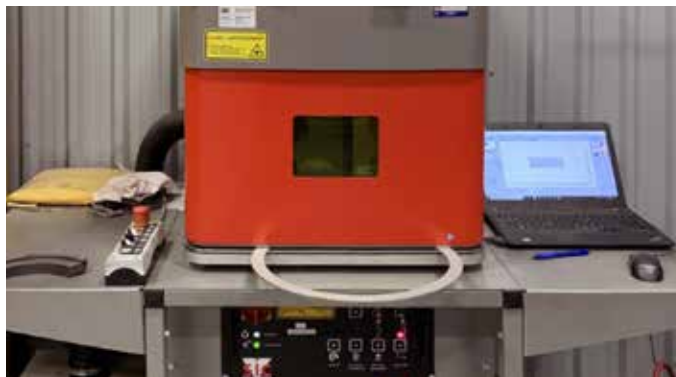

RCA® GASKETS

The Durlon® RCA® (Reduced Contact Area) sealing system combined with Durlon® PTFE styles, can replace standard Full Face gaskets in FRP, PVC, and other non-metallic and metallic pipe flanges, where a low stress gasket is required. The RCA® configuration reduces the total gasket contact area, resulting in a lower seating stress at a given torque level, while preventing flange rotation. The RCA® configuration can be cut from standard sheets resulting in a cost savings, versus other low stress gaskets. Available Materials: Durlon® PTFE and Compressed Non-Asbestos styles.

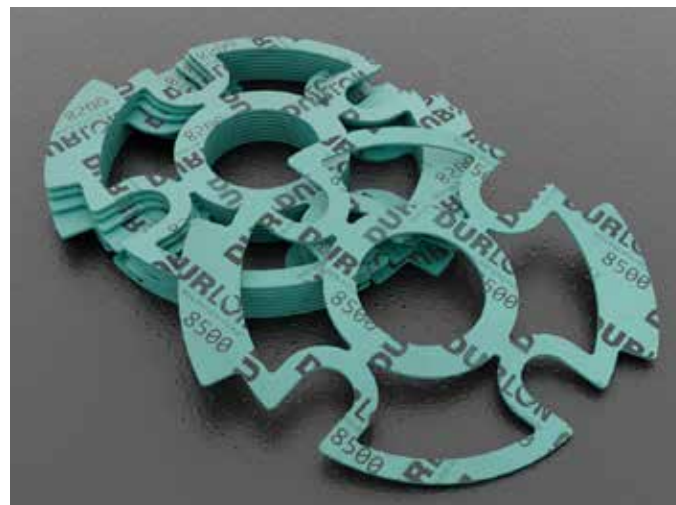

MODULA AUTOMATIC VERTICAL STORAGE SYSTEM

This vertical storage solution is perfect for making the most of the height of our warehouse while saving floor space; are the ideal answer for an orderly, clean, and safe work environment. At Durlon, we are always looking at ways to re-invest in our facilities, and with the acquisition of 3 Modula systems at TFC and 1 at GRI, we can recover space, save time, reduce risks and improve the accuracy of our inventory management.

These units are composed of a sturdy steel structure that houses and supports the trays, with a motorized central elevator to move them from the support shelves to the operator bays for picking and storing gaskets.



SKIVING

Durlon® PTFE skived materials give gasket cutters great value due to higher yields and optimal performance. With our proprietary manufacturing method, we are able to hold a tight thickness tolerance across a 60" sheet. Additionally, we are able to offer sheet lengths in 60" increments. Longer sheet lengths provide better yields and many gasket cutters prefer to take full rolls of material for continuous feed cutting operations.



BRANDING

Durlon® manufactured gasket sheets are branded with the production date* (month/year) and a batch number for full traceability to the raw materials used during processing.

*Applies to Compressed Non-Asbestos gasket sheets.



AUTOCAD AND DESIGN

Our AutoDesk CAD design programs (AutoCAD and Inventor Professional) allow us to create both 2D and 3D drawings of gaskets and components.



LAB CAPABILITIES

All our gasket testing is done in-house on both qualified raw material and finished gasket products. We perform various ASTM tests for gasket properties; tensile, creep, leakage, and compressibility/recovery. We have ovens for conditioning samples and performing our own oxidization testing on graphite and other high-temperature materials. Our Amtec machine allows us to perform all standard required gasket performance testing, along with other tests that require high levels of accuracy. We test gasket factors (EN 13555), ultra-low emissions leakage testing with the use of a helium mass spectrometer, and competitor material testing. We have PMI (Positive Material Identification), and hardness testing equipment for verification of all our metallurgy that is brought into the plant, and before being used for production.



METAL TRACING

Mill Test Reports (MTRs) provide traceability and assurance to the end user by stating the quality of the material, and the process used in its production. With MetalTrace® software, we create and manage MTRs which is easily available to our distribution channel via the MetalTrace® portal.



PACKAGING AND SHIPPING

At Durlon®, we take pride in our careful handling of gasket material when it comes to ensuring that they arrive at their destination in good condition. We do this by using packaging materials that is sturdy and durable, and wrap the gaskets in protective material to prevent them from rubbing against each other during transport. We use reliable and reputable shipping carriers that provide tracking numbers to monitor progress and ensure arrival at the destination on time.



3D Interactive Industry Application Videos

Explore interactive 3D industrial applications and see firsthand how our gaskets perform in real-world manufacturing environments. Navigate through detailed workflow processes to understand how our sealing solutions integrate into complex mechanical systems, delivering reliability and performance where it matters most.



Interactive
3D Applications



Manufacturing
Workflow Processes



Mechanical
Component Integration

Grow Your Business With Our Resources

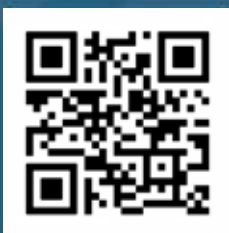

- ☑ Fertilizer Processing Plant
- ☑ Ethanol Production
- ☑ Sulfuric Acid Production Plant
- ☑ Copper Production
- ☑ Wastewater Plant
- ☑ Pulp and Paper Processing
- ☑ Thermal Power Plant
- ☑ Gold Processing
- ☑ Gas Plant
- ☑ And more to come!

igasket+ by DURLON

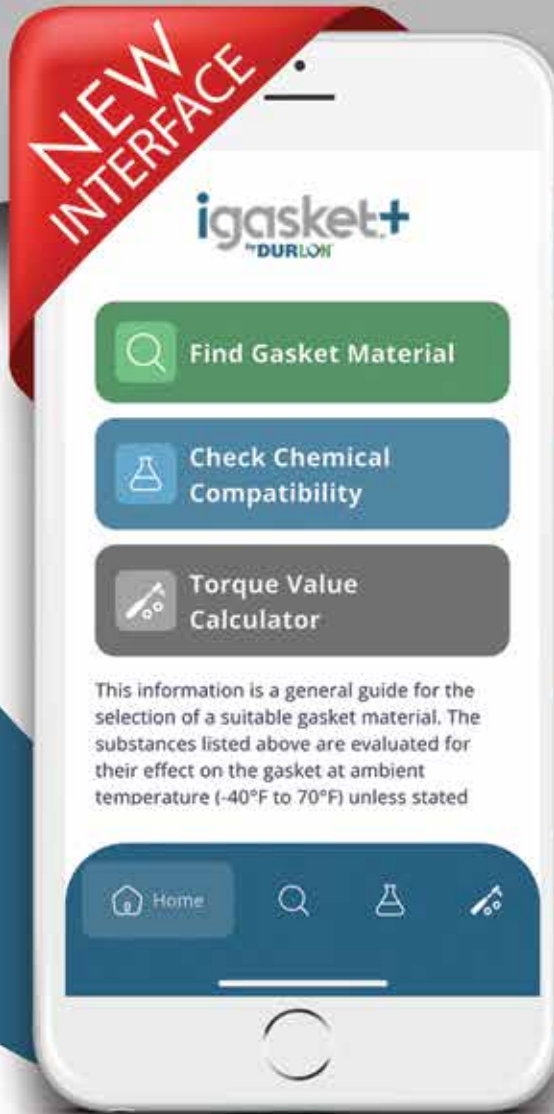

igasket+® App is a simple, intuitive interface that can be used by engineers and service technicians in the field. Based on a variety of user inputs, a list of compatible Durlon® gaskets is generated using temperature, pressure, fluid and flange type. Additional functionality: Chemical Compatibility and Torque Value Calculator.



www.igasketplus.com



DURLON[®]
SEALING SOLUTIONS



Durlon[®] is a registered trademark of Triangle Fluid Controls Ltd.[®] and Gasket Resources Inc.[®]

durlon.com • trianglefluid.com • gasketresources.com
durabla.ca • durlon.cn • durablaasia.com.sg