



Gasket Manual

- PTFE
- Metallics & Semi-Metallics
- Compressed Non-Asbestos
- Custom Fabrication

DURLON[®]
SEALING SOLUTIONS

Our Sealing Products

Durlon® Sealing Products have the widest possible range of service applications in comparison to major competitors, therefore, the number of different types of gaskets required to be inventoried can be greatly reduced. This impacts process safety, because limiting the number of gasket styles reduces the chance of installing the wrong gasket in the wrong service. For these reasons, more and more original equipment manufacturers and industrial consumers are specifying Durlon® gasket materials for their needs.

Durlon® compressed non-asbestos gasket materials are high-density products featuring the most homogeneous combination of minerals, synthetic fibers, and elastomers. They are used in a wide variety of industries on a broad range of chemical applications at varying temperatures and pressures. Their excellent flexibility prevents large, narrow flange gaskets from breaking during cutting and installation, and their superior recovery ensures tight sealing during thermal cycling.

Durlon® filled PTFE and flexible graphite gasket materials compliment our compressed sheet family, by giving you the right gasket for all of your gasket needs.

Durlon® PTFE gaskets are exclusively manufactured at our factory located in Belleville, Ontario, Canada. Our compression molded and skived manufacturing process allows for the best control of physical properties and performance characteristics as compared with other manufacturing processes. With unique formulas of fillers, Durlon® PTFE products can meet your tough chemical applications and engineering specifications.

Durlon® metallic gaskets are manufactured from a combination of metals and designed to withstand extreme temperatures, pressures

and chemical exposure. Available in standard and custom configurations, these rugged metal gaskets are made of a wide range of materials to accommodate all types of process applications.

Durlon® semi-metallic gaskets include both metallic and non-metallic components, either containing a metal core with sealing materials on both flat surfaces, or a pliable core encased in a thin metallic casing. They are most popular due to this configuration, and are available in a wide variety of styles and sizes. They can typically be fabricated of any metal which is available in thin strip or sheet, and which can be welded. Therefore, they can be used against virtually any corrosive medium dependent upon the choice of the metal and filler/facing material.

Our computer-aided manufacturing process uses rigorous quality control programs to ensure premium quality product performance. The metallic component gives the gasket superior structural integrity, while the non-metallic element ensures the superior sealing.

OUR MISSION

To provide global industries with high quality sealing solutions that are innovative, cost effective, and reduce fugitive emissions. We strive to grow our business with a keen eye towards customer service and delivering value to our employees, and customers through training and development opportunities, and world class technical support. “If it needs to stay between the pipes, it needs to be Durlon®”

We will accomplish this by:

- Our commitment to understanding and meeting or exceeding our customer’s expectations and requirements

- Continual improvements of our products, services and processes
- Remembering that we are here because of our customers

ADDITIONAL FEATURES

- Reliability backed by many years of experience
- Local distribution for quick and easy delivery
- Branding for easy identification and assurance of genuine Durlon® gasket material helps prevent misapplication
- A release agent on both sides of the CNA sheet ensures good anti-stick properties

Durlon® products are used in virtually every industrialized corner of the world. Our gasket materials are manufactured to ISO 9001 quality standards and are subjected to continuous testing and rigid quality control, ensuring unvarying performance on the job.

Our state-of-the-art research and development facility is geared to meet the ever changing demands required in today’s variety of service conditions. Since their inception, Durlon® gasket materials have undergone many enhancements, each incorporating the latest technology to better meet the wide variety of industry’s changing needs.

We recognize that today more emphasis is being placed on fugitive emissions via the Clean Air Act in Canada and the United States, as well as various regulations in other countries. One of our prime design objectives is to maximize the sealability of our gasket materials to meet and exceed fugitive emission requirements.

DURLON®
SEALING SOLUTIONS

Our Group of Companies

The Durlon® brand represents global leadership in sealing solutions with proven reliability, innovative processes and sustainable integrity in a wide range of demanding applications – oil & gas, chemical processing and power generation, to name just a few. We assure high-quality, environmentally-friendly materials from CNA & PTFE gasket sheets to flexible, metallic and high temperature gaskets.



Durabla Canada Ltd.
293 University Avenue
Belleville, ON K8N 5S3 Canada
844.636.1100
sales@durabla.ca
www.durabla.ca



Triangle Fluid Controls Ltd.
399 College St. E
Belleville, ON K8N 5S7 Canada
866.537.1133
info@trianglefluid.com
www.trianglefluid.com



Gasket Resources Inc.
280 Boot Road
Downingtown, PA 19335 USA
866.707.7300
sales@gasketresources.com
www.gasketresources.com



Gasket Resources Inc.
1814 Highway 146 South
La Porte, TX 77571
866.707.7300
sales@gasketresources.com
www.gasketresources.com



Durabla Asia Pte Ltd.
2 Venture Drive
#12-18 Vision Exchange
Singapore 608526
(65) 9722 1438
gasketinfo@durablaasia.com.sg
www.durablaasia.com.sg



Durabla Fluid Controls (Suzhou) Co. Ltd.
2 YongWu Road, BeiQiao Town
Xiangcheng District, Suzhou 215144
Jiangsu Province, P.R.China
(86) 51286896656
infochina@durlon.com
www.durlon.cn



Contents

6

Compressed Non-Asbestos Gasket Material

- 8 Durlon® 5000
- 10 Durlon® 7900
- 11 Durlon® 7910
- 12 Durlon® 7925
- 13 Durlon® 7950
- 14 Durlon® 8300
- 15 Durlon® 8400
- 16 Durlon® 8500
- 17 Durlon® 8600
- 18 Durlon® 8700
- 19 Durlon® 8900

20

PTFE Gasket Material

- 22 Durlon® 9000
- 23 Durlon® 9000N
- 24 Durlon® 9002
- 25 Durlon® 9200
- 26 Durlon® 9400
- 27 Durlon® 9600
- 28 Durlon® Virgin PTFE
- 29 Durlon® Joint Sealant

30

Low Seating Stress Gaskets

- 30 Durlon® RCA®
- 31 Durlon® CFG (Semi-Metallic)

32

Metallic & Semi-Metallic Gaskets

- 34 Durlon® Flexible Graphite
- 36 Durlon® HT1000®
- 37 Durlon® HT1000® Paste
- 38 Durlon® Durtec®
- 40 Durlon® SWG
- 42 Durlon® Kammprofile
- 43 Durlon® ETG
- 44 Durlon® RTJ

46

iGuard Isolation & Sealing Kits

50

Technical Information

- 50 Gasket Fundamentals
- 56 Gasket Installation
- 61 Gasket Factors
- 63 Torque Values
- 67 Chemical Resistance
- 75 Gasket Dimensions
- 87 Custom Fabrication

Note: ASTM properties are based on 1/16" sheet thickness, except ASTM F38 which is based on 1/32" sheet thickness. This is a general guide only and should not be the sole means of accepting or rejecting this material. The data listed here falls within the normal range of product properties, but should not be used to establish specifications limits nor used alone as the basis of design. For applications above Class 300, contact our technical department.

Warning: Durlon® gasket materials should never be recommended when both temperature and pressure are at the maximum listed. Properties and applications stated are typical. No applications should be undertaken by anyone without independent study and evaluation for suitability. Never use more than one gasket in one flange joint and never reuse a gasket. Improper use or gasket selection could cause property damage and/or serious injury. Data reported is a compilation of field testing, field service reports and/or in-house testing. While the utmost care has gone into publishing the information contained herein, we assume no responsibility for errors. Specifications and information contained in this flyer are subject to change without notice. This edition cancels and obsoletes all previous editions.

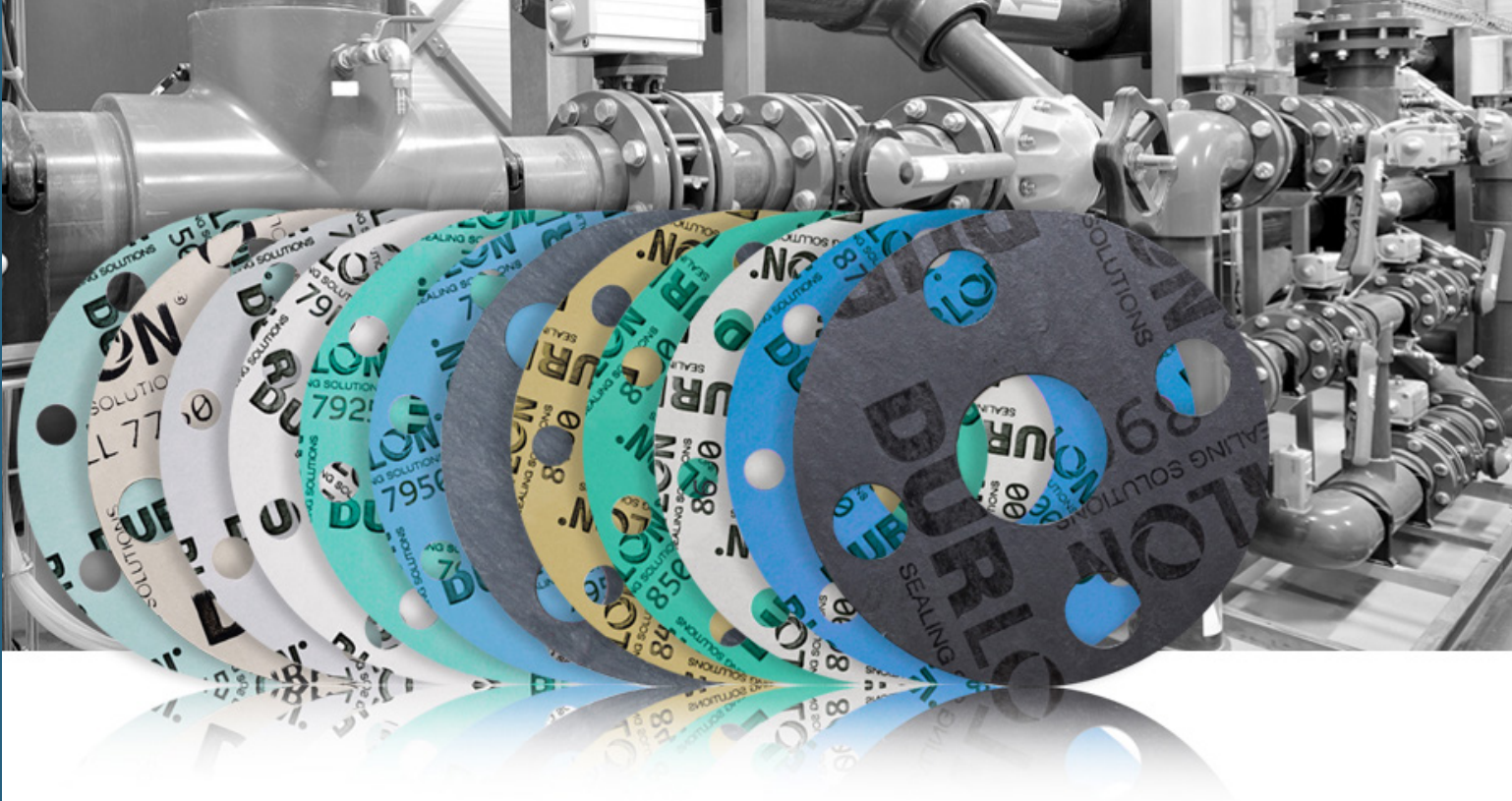

Compressed Non-Asbestos (CNA)

What is Compressed Non-Asbestos (CNA) gasket material?

Compressed Non-Asbestos is a sealing material consisting of a blend of organic and inorganic chemically resistant fibers and fillers together with an elastomer binder. The type of binder used is a key factor to consider when choosing a Compressed Non-Asbestos sheet for gasketing applications.

Manufacturers of compressed non-asbestos sheet produce a variety of materials that differ in the type of fibers and binders used which are purpose-suited for specific applications. Some sheets are designed for general service applications, while others are designed for use in applications involving chemicals, oils, extreme temperatures, etc.

How does Compressed Non-Asbestos differ from elastomers?

An elastomer is a polymer which possesses an elastic property. Elastomers are generally thermo-set materials which require curing through heat and pressure with the addition of sulphur or other curing agents. Natural and synthetic rubbers, such as styrene-butadiene rubber (SBR) and Buna-N (NBR), are elastomers.

Compressed Non-Asbestos, in contrast, is a material that combines organic and inorganic chemically resistant fibers and fillers. This type of binder employed gives the sheet the properties of elasticity and flexibility, while the fibers used give the sheet specific sealing characteristics and properties.

Why use Compressed Non-Asbestos sheets?

Compressed Non-Asbestos sheets have been developed to service a wide variety of sealing applications. These materials are an excellent choice for both general and severe service sealing applications.

Because Compressed Non-Asbestos sheet employs various combinations of fibers and binders, sheet manufacturers are able to produce a range of sheets with different mechanical specifications. Gaskets made from Compressed Non-Asbestos sheets have excellent sealing characteristics, torque retention, heat, and chemical resistance. These types of gaskets are an excellent choice for applications involving water, air, steam, oils, acids, and general chemicals. Our high performance industrial non-metallic gasket material sheets - Compressed Non-Asbestos contain high-pressure and high-temperature aramid fiber materials that are perfect for sealing, thermal, and mechanical applications (petrochemical, chemical, steam, pulp & paper, pharmaceutical and potable water industries).

Durlon® Compressed Non-Asbestos products range from economical to premium grades with organic and inorganic chemically resistant fibers and fillers to meet the majority of general service industrial piping applications and are the only products in its class to be manufactured by Durabla Canada Ltd., and have been since the early 1980's. Explore our CNA product styles for the one that meets your application requirements.

ENHANCED ANTI-STICK FORMULATION

Many gasket users have encountered problems with various compositions associated with flange adhesion for years.

Apart from the separation of flanges, surface imperfections can result from careless gasket removal. At elevated temperatures and pressures, there is a tendency for gasket materials to become embedded in the flange on opening. Sometimes disintegrated pieces stick to both flange mating surfaces, resulting in difficulty when removing the adhering gasket material in a safe, timely manner and without damaging the flanges. Many times, wire brushing or wire wheels are common practices, but if not done properly can lead to damaged process equipment or system contamination.

To overcome this problem, anti-stick technology is incorporated into the manufacturing process of the Compressed Non-Asbestos Durlon® products. This technology allows for improved separation from flange surfaces during removal, saving time and energy.

This new technology allows Durlon® CNA to be the best in the industry; gasket and sheet materials have passed the MIL-G-24696 Navy Adhesion Test: 48 hrs at 366°F (186°C).



MILITARY ADHESION MIL-G-24696

Adhesion Comparison between gaskets produced with Anti-Stick and without Anti-Stick.

Sample size: 1.25" X 2.0" X 1/16"

Installation: Between two platens - Carbon Steel and Stainless Steel
Torque: 30 ft-lb.

Test Conditions: 48 hours at 366°F (186°C)

Mil-G-24696 Rating (A lower value is favorable):

- 1 - Gasket can be removed cleanly with virtually no remaining residual material.
- 2 - Only a small amount of face material remains when gasket is removed.
- 3 - Can be removed in one piece but some face material remains on platen.
- 4 - Can be removed in one piece but a considerable amount of face material remains.
- 5 - Cannot be removed in one piece and delaminates upon removal.

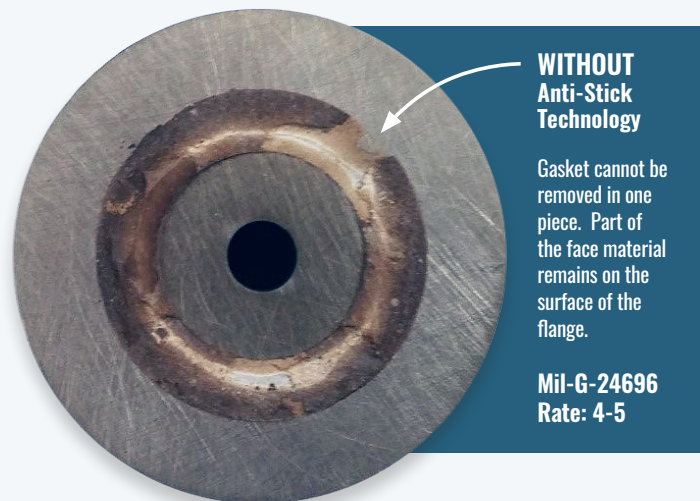
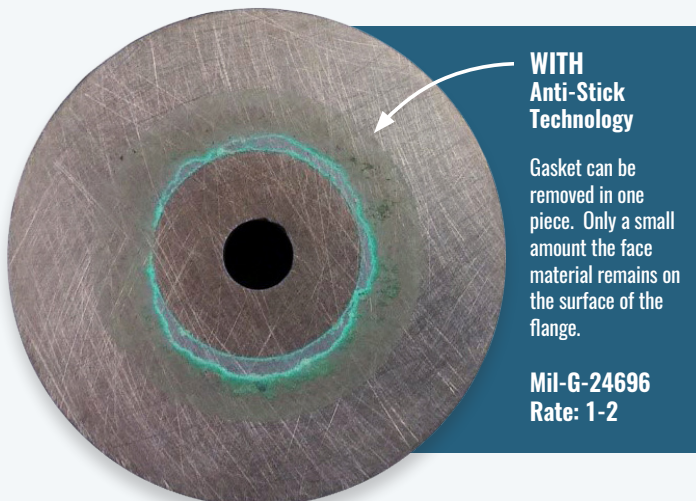

DURLON®

5000

Mineral Fiber with NBR Rubber Binder
Compressed Non-Asbestos Gasket Material
ASTM F104: F712120-A9B4E12K5L051M5



Physical Properties

Color	Light Green
Fiber System	Inorganic
Binder	NBR
Temperature: Min Max Continuous, Max	-73°C (-100°F) 288°C (550°F) 232°C (450°F)
Pressure, max, bar (psi)	69 (1,000)
Density, g/cc (lbs/ft³)	1.7 (106)
Compressibility, %	7-17
Recovery, %	40
Creep Relaxation, %	25
Tensile Strength, MPa (psi)	10.3 (1,500)
Nitrogen Sealability, ASTM 2378	0.05 cc/min
Fluid Resistance, ASTM F146 IRM 903 Oil 5hrs at 300°F Thickness Increase, % Weight Increase, % ASTM Fuel B 5hrs at 70°F Thickness Increase, % Weight Increase, %	0-15 10 0-10 10
Flexibility, ASTM F147	10x

A good quality commercial grade compressed non-asbestos sheet with good chemical resistance for moderate service conditions suitable for oil, water, mild alkalis, mild acids, hydrocarbons and solvents.

INDUSTRY APPLICATIONS:

- Chemical Processing
- Food & Beverage
- General Industry
- Marine
- Mining
- OEM Services
- Oil & Gas
- Water & Wastewater

Gasket Factors	1/16"	1/8"
m	1.5	2.5
Y psi (MPa)	1,855 (12.8)	2,619 (18.1)
G _b psi (MPa)	474 (3.3)	902 (6.2)
a	0.256	0.253
G _s psi (MPa)	48 (0.3)	4 (0.03)

Certifications

RoHS Reach Declaration	Compliant
------------------------	-----------

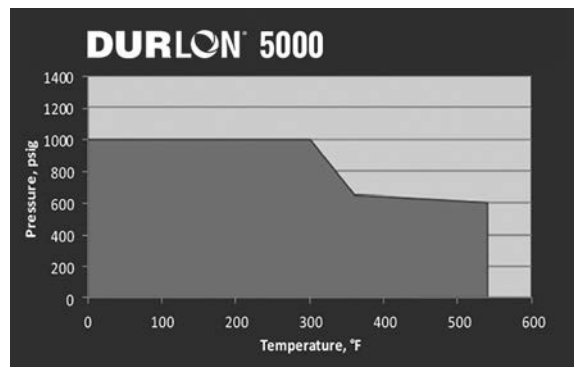

DURLON®

7900

Aramid with NBR Rubber Binder
Compressed Non-Asbestos Gasket Material
ASTM F104: F712120-A9B3E22K5L151M5



Physical Properties

Color	Off White
Fiber System	Aramid/Inorganic
Binder	NBR
Temperature: Min Max Continuous, Max	-73°C (-100°F) 371°C (700°F) 260°C (500°F)
Pressure, max, bar (psi)	83 (1,200)
Density, g/cc (lbs/ft³)	1.7 (106)
Compressibility, %	7-17
Recovery, %	40
Creep Relaxation, %	20
Tensile Strength, MPa (psi)	11 (1,600)
Sealability ASTM 2378 (Nitrogen)	0.05 cc/min
Fluid Resistance, ASTM F146 IRM 903 Oil 5hrs at 300°F Thickness Increase, % Weight Increase, %	0-15 15
ASTM Fuel B 5hrs at 70°F Thickness Increase, % Weight Increase, %	0-10 12
Flexibility, ASTM F147	10x

Durlon® 7900 is an economy grade general service gasket sheet material made with NBR (Nitrile Butadiene Rubber) binder for mild service in piping and equipment with applications in steam, hydrocarbons and refrigerants and an alternative when temperature and pressure conditions are below 500°F (260°C) and 1,200 psig (See P×T chart below for validation).

INDUSTRY APPLICATIONS:

- Chemical Processing
- General Industry
- Mining
- OEM Services
- Rail-Tank Car

Gasket Factors	1/16"	1/8"
m	3.0	3.2
Y psi (MPa)	3,347 (23.1)	3,385 (23.3)
G _b psi (MPa)	497 (3.4)	486 (3.4)
a	0.226	0.276
G _s psi (MPa)	3 (0.02)	0.4 (0.003)

Certifications

California Proposition 65	Compliant
RoHS Reach Declaration	Compliant

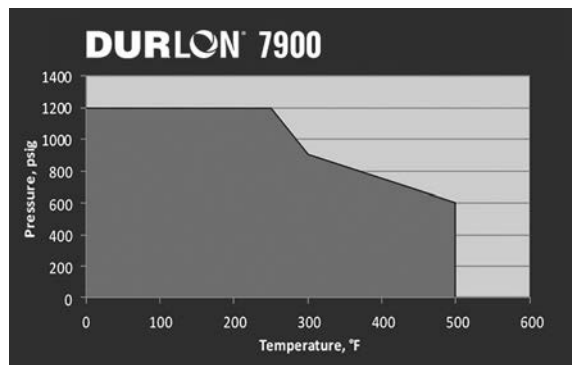

DURLON® 7910

Aramid with NBR Rubber Binder
Compressed Non-Asbestos Gasket Material
ASTM F104: F712120-A9B3E22K5L151M5



Physical Properties	
Color	White
Fiber System	Aramid/Inorganic
Binder	NBR
Temperature: Min Max Continuous, Max	-73°C (-100°F) 371°C (700°F) 260°C (500°F)
Pressure, max, bar (psi)	83 (1,200)
Density, g/cc (lbs/ft³)	1.7 (106)
Compressibility, %	9-19
Recovery, %	40
Creep Relaxation, %	25
Tensile Strength, MPa (psi)	11 (1,600)
Sealability ASTM 2378 (Nitrogen), cc/min	0.05
Fluid Resistance, ASTM F146 IRM 903 Oil 5hrs at 300°F Thickness Increase, % Weight Increase, % ASTM Fuel B 5hrs at 70°F Thickness Increase, % Weight Increase, %	0-15 15 0-10 12
Flexibility, ASTM F147	10x
Dielectric Breakdown, ASTM D149 kV/mm (V/mil)	11.0 (279)

As a quality, commercial grade compressed sheet gasket material, Durlon® 7910 was specifically developed to meet the requirement of NSF/ANSI 61 (Certification for water treatment products that are manufactured, distributed or sold in North America) for potable water application 23°C (73°F) to commercial hot 82°C (180°F).

BENEFIT: Durlon® 7910 has a strong dielectric rating, making it ideal for isolation kit (pg. 46) applications where compressed fibre sheet gaskets can be utilized.

INDUSTRY APPLICATIONS:

- General Industry
- Water & Wastewater
- OEM Services

Gasket Factors	1/16"	1/8"
m	1.5	1.5
Y psi (MPa)	2,416 (16.7)	3,576 (24.7)
G _b psi (MPa)	502 (3.5)	736 (5.1)
a	0.289	0.237
G _s psi (MPa)	0.001 (0)	9.1 (0.131)

Certifications	
NSF/ANSI 61	Certified to meet the requirement of NSF/ANSI 61 for potable water application at 23°C (73°F) to commercial hot to 82°C (180°F)
RoHS Reach Declaration	Compliant

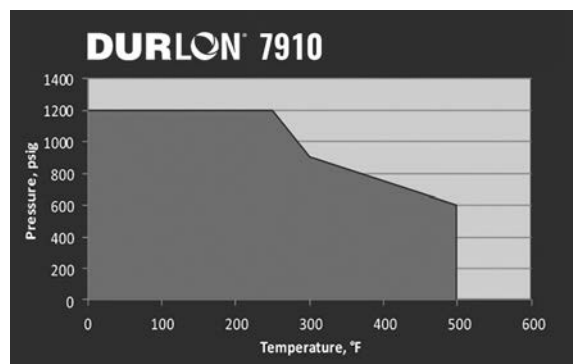

DURLON®

7925

Aramid with NBR Rubber Binder
Compressed Non-Asbestos Gasket Material
ASTM F104: F712120-A9B3E22K5L151M5



Physical Properties

Color	Light Green
Fiber System	Aramid/Inorganic
Binder	NBR
Temperature: Min Max Continuous, Max	-73°C (-100°F) 371°C (700°F) 260°C (500°F)
Pressure, max, bar (psi)	83 (1,200)
Density, g/cc (lbs/ft³)	1.7 (106)
Compressibility, %	7-17
Recovery, %	40
Creep Relaxation, %	20
Tensile Strength, MPa (psi)	11 (1,600)
Sealability ASTM 2378 (Nitrogen)	0.05 cc/min
Fluid Resistance, ASTM F146 IRM 903 Oil 5hrs at 300°F Thickness Increase, % Weight Increase, % ASTM Fuel B 5hrs at 70°F Thickness Increase, % Weight Increase, %	0-15 15 0-10 12
Flexibility, ASTM F147	10x

Durlon® 7925 is an economy grade general service gasket sheet material made with NBR (Nitrile Butadiene Rubber) binder for mild service in piping and equipment with applications in steam, hydrocarbons and refrigerants and an alternative when temperature and pressure conditions are below 500°F (260°C) and 1,200 psig (See PxT chart below for validation).

INDUSTRY APPLICATIONS:

- Chemical Processing
- General Industry
- Mining
- OEM Services

Gasket Factors	1/16"	1/8"
m	3.0	3.2
Y psi (MPa)	3,347 (23.1)	3,385 (23.3)
G _b psi (MPa)	497 (3.4)	486 (3.4)
a	0.226	0.276
G _s psi (MPa)	3 (0.02)	0.4 (0.003)

Certifications

California Proposition 65	Compliant
RoHS Reach Declaration	Compliant

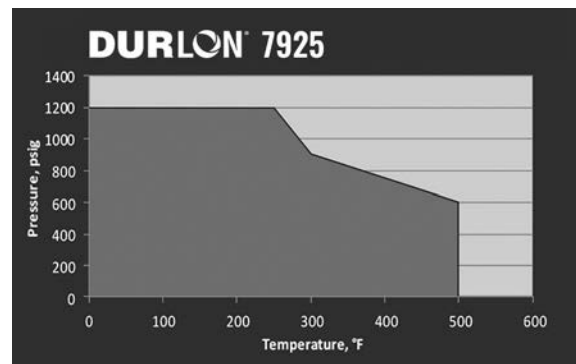

DURLON® 7950

Aramid with NBR Rubber Binder
Compressed Non-Asbestos Gasket Material
ASTM F104: F712120-A9B3E22K5L151M5



Physical Properties	
Color	Blue
Fiber System	Aramid/Inorganic
Binder	NBR
Temperature: Min Max Continuous, Max	-73°C (-100°F) 371°C (700°F) 260°C (500°F)
Pressure, max, bar (psi)	83 (1,200)
Density, g/cc (lbs/ft³)	1.7 (106)
Compressibility, %	7-17
Recovery, %	40
Creep Relaxation, %	20
Tensile Strength, MPa (psi)	11 (1,600)
Sealability ASTM 2378 (Nitrogen)	0.05 cc/min
Fluid Resistance, ASTM F146 IRM 903 Oil 5hrs at 300°F Thickness Increase, % Weight Increase, % ASTM Fuel B 5hrs at 70°F Thickness Increase, % Weight Increase, %	0-15 15 0-10 12
Flexibility, ASTM F147	10x

Durlon® 7950 is an economy grade general service gasket sheet material made with NBR (Nitrile Butadiene Rubber) binder for mild service in piping and equipment with applications in steam, hydrocarbons and refrigerants and an alternative when temperature and pressure conditions are below 500°F (260°C) and 1,200 psig (See P×T chart below for validation).

INDUSTRY APPLICATIONS:

- Chemical Processing
- Mining
- General Industry
- OEM Services

Gasket Factors	1/16"	1/8"
m	3.0	3.2
Y psi (MPa)	3,347 (23.1)	3,385 (23.3)
G _b psi (MPa)	497 (3.4)	486 (3.4)
a	0.226	0.276
G _s psi (MPa)	3 (0.02)	0.4 (0.003)

Certifications	
California Proposition 65	Compliant
RoHS Reach Declaration	Compliant

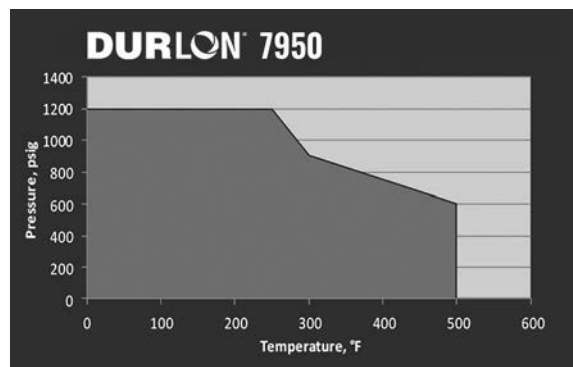

DURLON® 8300

Carbon Fiber with NBR Rubber Binder
Compressed Non-Asbestos Gasket Material
ASTM F104: F712120-A9B3E22K5L311M5



Physical Properties

Color	Black
Fiber System	Carbon
Binder	NBR
Temperature: Min	-73°C (-100°F)
Max	482°C (900°F)
Continuous, Max	343°C (650°F)
Pressure, max, bar (psi)	139 (2,000)
Density, g/cc (lbs/ft³)	1.6 (100)
Compressibility, %	8-16
Recovery, %	50
Creep Relaxation, %	18
Tensile Strength, MPa (psi)	12.4 (1,800)
Sealability ASTM 2378 (Nitrogen)	0.05 cc/min
Fluid Resistance, ASTM F146 IRM 903 Oil 5hrs at 300°F	
Thickness Increase, %	0-10
Weight Increase, %	10
ASTM Fuel B 5hrs at 70°F	
Thickness Increase, %	0-10
Weight Increase, %	12
Flexibility, ASTM F147	10x
Volume Resistivity, ohm-cm ASTM D257	5.0 x 10 ⁹
Dielectric Breakdown ASTM D149, kV/mm (V/mil)	0.04 (1)

Durlon® 8300 is a premium grade compressed sheet gasket material that is excellent in steam and hydrocarbon services for the refining, petrochemical and power generation industries and designed to handle the extreme pressure and temperature applications that include oil, water, mild alkalis, mild acids and solvents.

INDUSTRY APPLICATIONS:

- Chemical Processing
- General/Heavy Industry
- Mining
- OEM Services
- Oil & Gas
- Petrochemical
- Power Generation
- Refining

Gasket Factors	1/16"	1/8"
m	3.7	3.0
Y psi (MPa)	3,515 (24.2)	4,014 (27.7)
G _b psi (MPa)	512 (3.5)	460 (3.2)
a	0.355	0.313
G _s psi (MPa)	13 (0.09)	0.427 (.003)

Certifications

California Proposition 65	Compliant
RoHS Reach Declaration	Compliant

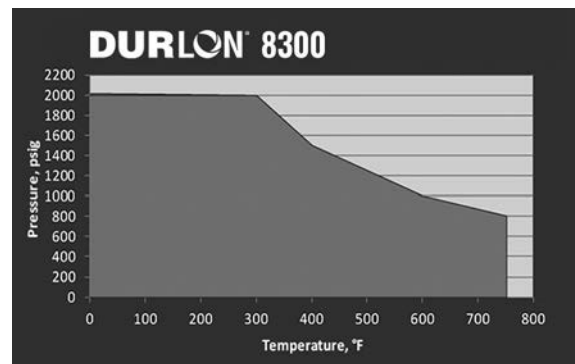

DURLON® 8400

Phenolic Fiber with NBR Rubber Binder
Compressed Non-Asbestos Gasket Material
ASTM F104: F712120-A9B4E22K5L911M5

Physical Properties	
Color	Gold
Fiber System	Phenolic
Binder	NBR
Temperature: Min	-73°C (-100°F)
Max	427°C (800°F)
Continuous, Max	290°C (554°F)
Pressure, max, bar (psi)	103 (1,500)
Density, g/cc (lbs/ft ³)	1.7 (106)
Compressibility, %	8-16
Recovery, %	50
Creep Relaxation, %	25
Tensile Strength, MPa (psi)	12.4 (1,800)
Sealability ASTM 2378 (Nitrogen)	0.03 cc/min
Fluid Resistance, ASTM F146 IRM 903 Oil 5hrs at 300°F	0-15
Thickness Increase, %	
Weight Increase, %	15
ASTM Fuel B 5hrs at 70°F	0-10
Thickness Increase, %	
Weight Increase, %	15
Flexibility, ASTM F147	8x
Volume Resistivity, ohm-cm ASTM D257	3.1 x 10 ¹³
Dielectric Breakdown ASTM D149, kV/mm (V/mil)	14.6 (371)



With an extremely wide pH application range (2-13 at room temp.) Durlon® 8400 can be used in process piping and equipment in chemical, pulp & paper and other general industrial applications. A unique high-performance compressed sheet, Durlon® 8400 is an excellent gasket material for use in steam, mild caustics and acids.

BENEFIT: Durlon® 8400 has a strong dielectric rating, making it ideal for isolation kit (pg. 46) applications where compressed fibre sheet gaskets can be utilized.

INDUSTRY APPLICATIONS:

- Chemical Processing
- Food & Beverage
- General/Heavy Industry
- Mining
- OEM Services
- Power Generation
- Pulp & Paper
- Water & Wastewater

Gasket Factors	1/16"	1/8"
m	2.9	4.5
Y psi (MPa)	2,410 (16.6)	3,967 (27.4)
G _b psi (MPa)	380 (2.6)	391 (2.7)
a	0.311	0.321
G _s psi (MPa)	0.01 (.001)	0.014 (.001)

Certifications

California Proposition 65	Compliant
RoHS Reach Declaration	Compliant

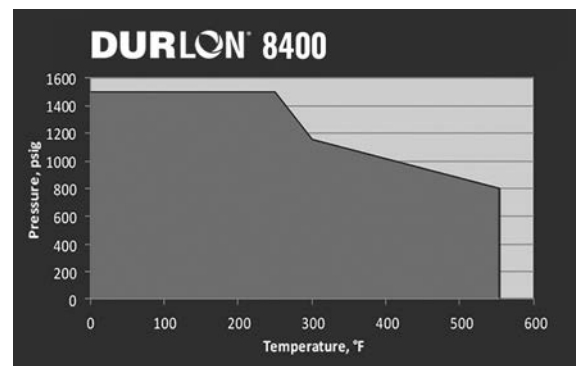

DURLON®

8500

Aramid/Inorganic with NBR Rubber Binder
Compressed Non-Asbestos Gasket Material
ASTM F104: F712120-A9B3E12K5L151M6



Physical Properties

Color	Green
Fiber System	Aramid/Inorganic
Binder	NBR
Temperature: Min Max Continuous, Max	-73°C (-100°F) 371°C (700°F) 287°C (548°F)
Pressure, max, bar (psi)	103 (1,500)
Density, g/cc (lbs/ft³)	1.7 (106)
Compressibility, %	8-16
Recovery, %	50
Creep Relaxation, %	20
Tensile Strength, MPa (psi)	13.8 (2,000)
Sealability ASTM 2378 (Nitrogen)	0.03 cc/min
Fluid Resistance, ASTM F146 IRM 903 Oil 5hrs at 300°F Thickness Increase, % Weight Increase, % ASTM Fuel B 5hrs at 70°F Thickness Increase, % Weight Increase, %	0-15 15 0-10 10
Flexibility, ASTM F147	10x
Volume Resistivity, ohm-cm ASTM D257	4.2×10^{13}
Dielectric Breakdown ASTM D149, kV/mm (V/mil)	11.7 (297)

A high performance compressed gasket material for use in process industries including pulp & paper, food & beverage, pharmaceutical, hydrocarbon, chemical, refinery and general industry.

BENEFIT: Durlon® 8500 has a strong dielectric rating, making it ideal for isolation kit (pg. 46) applications where compressed fibre sheet gaskets can be utilized.

INDUSTRY APPLICATIONS:

- Chemical Processing
- Water & Wastewater
- Petrochemical
- Food & Beverage
- General/Heavy Industry
- Refining
- Mining
- OEM Services

Gasket Factors	1/16"	1/8"
m	2.7	4.2
Y psi (MPa)	2,359 (16.3)	2,931 (20.2)
G _b psi (MPa)	650 (4.5)	400 (2.8)
a	0.33	0.35
G _s psi (MPa)	200 (1.4)	20 (0.1)

Certifications

California Prop 65	Compliant
RoHS Reach Declaration	Compliant
API 6FB Fire Test	With avg. temp. >650°C, 30 min., 40 bar, 1 ml (inch/min.) max allowable leakage
FDA	Conforms to requirements of 21 CFR 177.2600

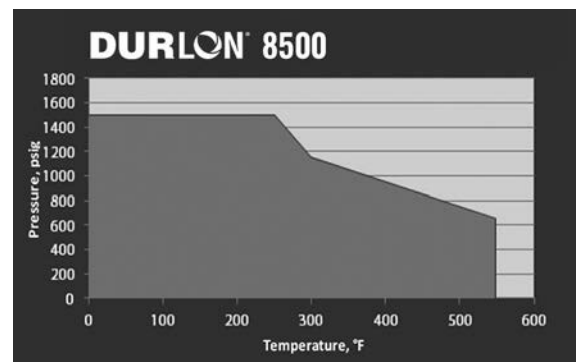

DURLON® 8600

Aramid/Inorganic with SBR Rubber Binder
Compressed Non-Asbestos Gasket Material
ASTM F104: F712440-A9B3E24K5L152M5



Physical Properties	
Color	White
Fiber System	Aramid/Inorganic
Binder	SBR
Temperature: Min Max Continuous, Max	-73°C (-100°F) 371°C (700°F) 287°C (548°F)
Pressure, max, bar (psi)	103 (1,500)
Density, g/cc (lbs/ft³)	1.7 (106)
Compressibility, %	8-16
Recovery, %	45
Creep Relaxation, %	20
Tensile Strength, MPa (psi)	12.4 (1,800)
Sealability ASTM 2378 (Nitrogen)	0.05 cc/min
Fluid Resistance, ASTM F146 IRM 903 Oil 5hrs at 300°F Thickness Increase, % Weight Increase, % ASTM Fuel B 5hrs at 70°F Thickness Increase, % Weight Increase, %	15-30 30 5-20 30
Flexibility, ASTM F147	8x
Volume Resistivity, ohm-cm ASTM D257	4.2 x 10 ¹³
Dielectric Breakdown ASTM D149, kV/mm (V/mil)	11.7 (297)

Durlon® 8600 is a quality compressed sheet gasket material for use in process industries including pulp & paper, power, petrochemical as well as general industry where a “white” gasket material is often required when working with food & beverage, pharmaceutical and plastics.

INDUSTRY APPLICATIONS:

- Chemical Processing
- Mining
- Food & Beverage
- OEM Services
- General Industry
- Water & Wastewater

Gasket Factors	1/16”	1/8”
m	2.9	4.6
Y psi (MPa)	2,540 (17.5)	3,200 (22.1)
G _b psi (MPa)	343 (2.4)	866 (5.9)
a	0.325	0.273
G _s psi (MPa)	0.3 (0.002)	37 (0.255)

Certifications

California Proposition 65	Compliant
RoHS Reach Declaration	Compliant

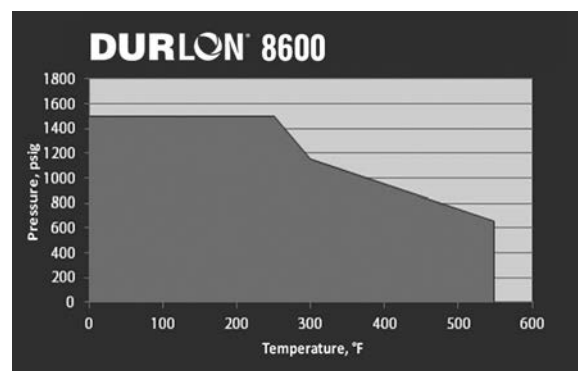

DURLON® 8700

Aramid/Inorganic with CR Rubber Binder
Compressed Non-Asbestos Gasket Material
ASTM F104: F712330-A9B5E45K5L153M5



Physical Properties

Color	Blue
Fiber System	Aramid/Inorganic
Binder	CR
Temperature: Min Max Continuous, Max	-73°C (-100°F) 371°C (700°F) 287°C (548°F)
Pressure, max, bar (psi)	103 (1,500)
Density, g/cc (lbs/ft³)	1.7 (106)
Compressibility, %	8-16
Recovery, %	45
Creep Relaxation, %	20
Tensile Strength, MPa (psi)	10.3 (1,500)
Sealability ASTM F2378 (Nitrogen)	0.05 cc/min
Fluid Resistance, ASTM F146 IRM 903 Oil 5hrs at 300°F Thickness Increase, % Weight Increase, % ASTM Fuel B 5hrs at 70°F Thickness Increase, % Weight Increase, %	10-15 20 5-20 20
Flexibility, ASTM F147	8x
Volume Resistivity, ohm-cm ASTM D257	4.2×10^{13}
Dielectric Breakdown ASTM D149, kV/mm (V/mil)	11.7 (297)

Durlon® 8700 is a high performance gasket material for use in processes requiring a neoprene (CR) bonded sheet and has excellent hand and die cutting characteristics. This product has excellent resistance to ozone, oils, non-aromatic solvents and many refrigerants.

INDUSTRY APPLICATIONS:

- Chemical Processing
- General Industry
- Mining
- OEM Services
- Oil & Gas

Gasket Factors	1/16"	1/8"
m	3.1	5
Y psi (MPa)	3,127 (21.6)	4,000 (27.6)
G _b psi (MPa)	546 (3.8)	758 (5.2)
a	0.455	0.34
G _s psi (MPa)	12 (0.083)	0.01 (0.0001)

Certifications

California Proposition 65	Compliant
RoHS Reach Declaration	Compliant

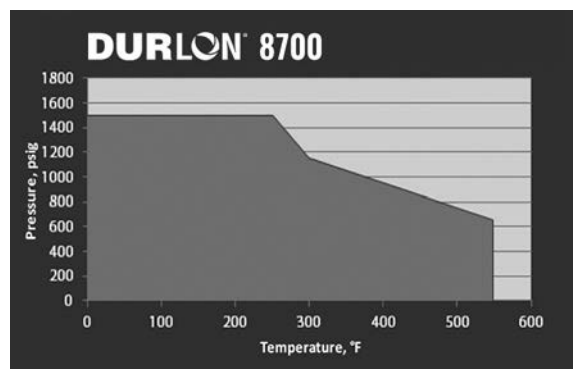

DURLON® 8900

Aramid-Graphite with NBR Rubber Binder
Compressed Non-Asbestos Gasket Material
ASTM F104: F712120-A9B2E21L101M6



Physical Properties	
Color	Black
Fiber System	Aramid/Inorganic
Binder	NBR
Temperature: Min	-73°C (-100°F)
Max	496°C (925°F)
Continuous, Max	400°C (752°F)
Pressure, max, bar (psi)	138 (2,000)
Density, g/cc (lbs/ft³)	1.6 (100)
Compressibility, %	7-17
Recovery, %	50
Creep Relaxation, %	15
Tensile Strength, MPa (psi)	13.8 (2,000)
Sealability: ASTM 2378 (Nitrogen)	0.2 cc/min
Fluid Resistance, ASTM F146 IRM 903 Oil 5hrs at 300°F	
Thickness Increase, %	3
Weight Increase, %	15
ASTM Fuel B 5hrs at 70°F	
Thickness Increase, %	4
Weight Increase, %	12
Flexibility, ASTM F147	12x
Volume Resistivity, ohm-cm ASTM D257	4.01 x 10 ⁰
Stress Relaxation, DIN 52913 @ 7,252psi (50 MPa)	
16 hr @ 347°F (175°C)	6,500 (44.8) Min.
16 hr @ 572°F (300°C)	6,000 (41.4) Min.

A premium grade material for service conditions to 496°C (925°F) and continuous operating temperatures of -73°C to 400°C (-100°F to 752°F). Durlon® 8900 is ideal for saturated and superheated steam, oil, dilute acids and alkalis, hydrocarbons and solvents.

INDUSTRY APPLICATIONS:

- Chemical Processing
- Oil & Gas
- Food & Beverage
- Petrochemical
- General Industry
- Refining
- Mining
- Water & Wastewater
- OEM Services

Gasket Factors	1/16"	1/8"
m	4.8	7.3
Y psi (MPa)	4,851 (33.4)	3,730 (25.7)
G _b psi (MPa)	915 (6.3)	567 (3.9)
a	0.428	0.556
G _s psi (MPa)	0.02 (0.0001)	0.26 (0.002)

Certifications	
ANSI/API 607 Fire Test	6th Ed., Zero leakage
RoHS Reach Declaration	Compliant

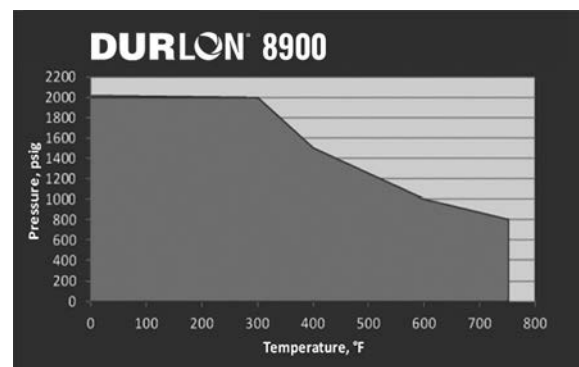



PTFE (Polytetrafluoroethylene)

From interplanetary deep space missions to sealing the fittings between the faucets and pipes in your kitchen sink, Polytetrafluoroethylene (PTFE) can be found being used in almost every aspect of our daily lives.

The unique properties of PTFE lend itself well for use in a variety of industrial, manufacturing, and engineering facilities. The superb chemical resistance and tolerance to vast temperature gradients has not only improved the efficiency of many industries, but the safety for the employees that work around those conditions as well.

ADVANTAGES OF USING FILLED PTFE COMPOUNDS:

- Excellent chemical resistance
- Wide range of service temperature
- Excellent dielectric properties
- Non-stick, low friction
- No embrittlement or aging
- Smooth surface finish can be achieved
- Non-wetting
- Outstanding corrosion protection
- Electrical insulation
- High thermal stability and flame resistance
- Resistance to weathering
- Food grade compliant

COMMON GRADES OF PTFE:

Virgin PTFE

“Virgin PTFE” (PTFE without a filler) is one of the most chemically inert materials known and is used in many different applications and industries.

Glass Filled PTFE

Virgin PTFE with 20-30% Glass filler which dramatically increases compressive strength and lowers deformation under load.

Carbon Filled PTFE

The addition of carbon to PTFE increases the compressive strength and wear resistance. It provides good thermal conductivity and low permeability.

Barium Sulfate Filled PTFE

The addition of barium sulphate to PTFE offers excellent resistance to cold flow and creep, bolt-load retention, outstanding dimensional stability under thermal stress, and resists a variety of chemicals.

HYDROGEN FLUORIDE RESISTANCE

Hydrogen fluoride is a critical chemical used in many industries, including metal manufacturing and petroleum production. It's also highly reactive and corrosive.

Given the serious health and environmental hazards associated with hydrogen fluoride, the Environmental Protection Agency (EPA) requires immediate reporting of any leaks; even a minor leak can result in plant shutdown, significantly affecting overall operations, downtime, labor needs, and costs.

The Hydrogen Fluoride Industry Practices Institute (HFIP) publishes a Materials of Construction Guideline to help ensure the safest possible industrial use of hydrogen fluoride. Within this guide, PTFE, or Teflon™, is listed as a safe sealant for hydrogen fluoride.

PROCESSING PTFE

Because PTFE is a thermoplastic and due to its high viscosity, it cannot be processed using conventional polymer processing techniques. PTFE is processed by cold shaping and followed by heat treatment (sintering) during which polymer particles fuse to form a solid molding.

PTFE is highly resistant to corrosion due to its chemical inertness. Unfortunately, that same chemical inertness prevents PTFE from being cross-linked like elastomers and is subject to the phenomenon of cold flow – otherwise known as “creep”. To reduce and diminish cold flow, additives are introduced during the preparation of PTFE compounds. Glass fillers found in Durlon® 9000 and 9000N gaskets, not only reduce creep but also maintain chemical inertness against aggressive and caustic chemicals but are still considered safe for use by food, drug, and medical services.

MECHANICAL GRADE VIRGIN PTFE

Both Mechanical grade PTFE and Virgin Skived PTFE are manufactured the same way. The main thing that distinguishes the two products is the resin system that is used during material manufacturing.

Mechanical grade PTFE is made from reprocessed or recycled PTFE resin. This results in a more economical sheet with slightly lower physical properties for applications that do not require high levels of purity and is not suitable for food contact. Generally suitable for non critical chemical applications or other non-sealing uses such as electrical isolation or mechanical applications

Virgin Skived PTFE is made from new and only pure PTFE resin. This results in higher quality sheet with improved physical properties when compared to mechanical grade PTFE. Due to the high purity level, it can be used in many pharmaceutical or food contact processed due to its FDA compliance.

CALENDERED PTFE VERSUS SKIVED PTFE

Durlon® PTFE is manufactured via skived method, vs our competitors that utilize the HS-10 calendar method. The calendered method has some downfalls such as sheet thickness tolerance and perhaps the main fall-back is that the sheet length can only be as long as the circumference of the roll - in most cases this is only 60” (1500mm).

Durlon® skived PTFE benefits feature tighter sheet tolerances and sheet lengths that can be cut in 60” increments. We offer 1/8” sheets in 60” x 60”, 60” x 120”, 60” x 180”, 60” x 300” and up to 60” x 110 linear feet if you truly required it. The benefit of longer or continual sheets can result in an increase of up to 30%* gasket cutting yield. **Based on gaskets size/qty*

Through our 3rd party testing of our Durlon® PTFE vs competitor calendered sheets, we can dispel the following myths about skived material: stratification of fillers, uneven disbursement of fillers, and tensile strength variation due to unidirectional compression loading. **Ask to see our data*

Durlon® 9000 & 9000N PTFE SHEETS & GASKETS

Various shapes of inorganic fillers have been homogeneously blended with pure PTFE resins to give Durlon® 9000 its physical and mechanical properties. It is suitable for use in steel flanges and will not exhibit the cold flow problems associated with virgin PTFE or the hardness problems of some other filled PTFE products. It cuts easily and separates cleanly from flanges after use.

CERTIFICATIONS

Durlon® 9000 – API 607 Standard 6FA Fire Test, WRAS, TA-Luft (VDI 2440), ASTM G86, Pamphlet 95 (Chlorine Institute), FDA Compliant, USP Class VI Certified, ABS-PDA Certified, EC 1935/2004 Compliant, DNV-GL Accreditation, RoHS Reach Declaration

Durlon® 9000N – FDA compliant, ABS-PDA Certified, USP Class VI Certified, RoHS Reach Declaration

Durlon® filled PTFE gaskets/sheets are exclusively manufactured at Triangle Fluid Controls Ltd. in Belleville, ON, Canada. Our compression molded and skived manufacturing process allows for the best control of physical properties and performance characteristics compared to other manufacturing processes. With unique formulas of fillers, Durlon® PTFE products can meet your tough chemical applications and engineering specifications.

DURLON® 9000

Inorganic Filler with Pure PTFE Resins
Filled PTFE Gasket Material
ASTM F104: F452111-A9B5E11K6M6

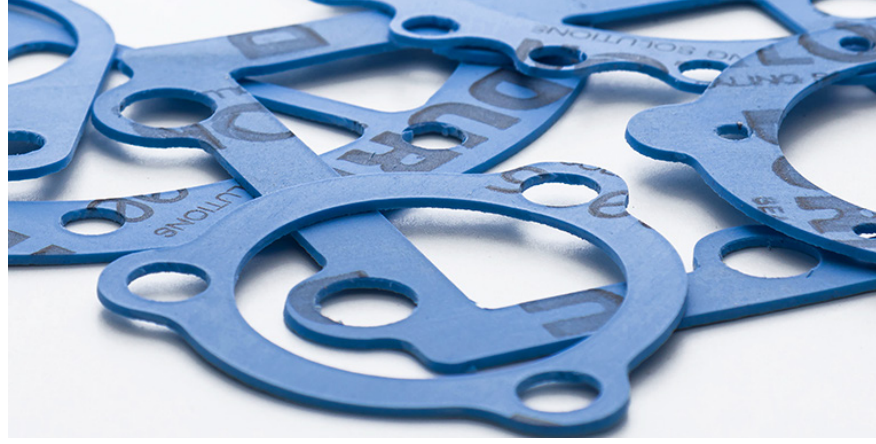

Physical Properties

Color	Blue
Filler System	Inorganic
Temperature: Min	-212°C (-350°F)
Max	271°C (520°F)
Continuous, Max	260°C (500°F)
Pressure, max, bar (psi)	103 (1,500)
Density, g/cc (lbs/ft³)	2.2 (138)
Compressibility, %	8-16
Recovery, %	40
Creep Relaxation, %	30
Tensile Strength, MPa (psi)	13.8 (2,000)
Sealability: ASTM 2378 (Nitrogen)	0.01 cc/min
Leakage, mbar .1 (m .5) TA-Luft (VDI 2440) iBar (14.5 psi) @180°C (392°F)	7.55 x 10 ⁻⁶
Volume Resistivity, ohm-cm ASTM D257	1.0 x 10 ⁵
Dielectric Breakdown ASTM D149, kV/mm (V/mil)	16 (406)

Gasket Factors	1/16"	1/8"
m	2.2	4.6
Y psi (MPa)	1,937 (13.4)	1,639 (11.3)
G _b psi (MPa)	639 (4.4)	495 (3.4)
a	0.220	0.262
G _s psi (MPa)	55 (0.379)	65 (0.448)

Durlon® 9000 is for use in general industrial applications where resistance to highly aggressive chemicals is required. In addition, the shape of the fillers does not allow wicking which can cause corrosion on flange surfaces.

BENEFIT:

Durlon® 9000 has a strong dielectric rating, making it ideal for isolation kit (pg. 46) applications where PTFE sheet gaskets can be utilized.

INDUSTRY APPLICATIONS:

- Chemical Processing
- Food & Beverage
- General/Heavy Industry
- Marine
- Mining
- OEM Services
- Oil & Gas
- Petrochemical
- Pharmaceutical
- Power Generation
- Pulp & Paper
- Refining
- Water & Wastewater

Certifications

API 6FA*, 3rd Edition Fire Test	Passed
WRAS	Approved Material
USP Class VI	Met requirements for Plastic Class VI - 121°C (250°F)
FDA	Met requirements of 21 CFR 177.1550
TA-luft (VDI Guideline 2440)	Approved Material
ABS-PDA & Pamphlet 95, the chlorine institute, DNV-GL	Approved Material
(EC) 1935/2004 & EU (10/2011)	Approved Material

*6 inch Class 300. The test fixture was subjected to an external flame of 875°C (1607°F) average for 30 minutes. The measured leakage was 1.8 ml/min, where the max allowable limit is 1200 ml/min.

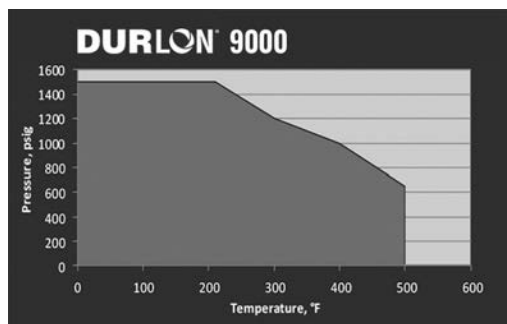

Durlon® 9000 is made with Teflon™ fluoropolymer. Teflon™ is a trademark of The Chemours Company FC, LLC used under license by Triangle Fluid Controls Ltd.

DURLON® 9000N

Inorganic Filler with Pure PTFE Resins
Filled PTFE Gasket Material
ASTM F104: F452111-A9B5E11K6M6



Physical Properties	
Color	White
Filler System	Inorganic
Temperature: Min Max Continuous, Max	-212°C (-350°F) 271°C (520°F) 260°C (500°F)
Pressure, max, bar (psi)	103 (1,500)
Density, g/cc (lbs/ft³)	2.2 (138)
Compressibility, %	8-16
Recovery, %	40
Creep Relaxation, %	30
Tensile Strength, MPa (psi)	13.8 (2,000)
Sealability ASTM 2378 (Nitrogen)	0.01 cc/min
Volume Resistivity, ohm-cm ASTM D257	1.0 x 10 ⁵
Dielectric Breakdown ASTM D149, kV/mm (V/mil)	16 (406)

Durlon® 9000N is for use in general industrial applications where resistance to highly aggressive chemicals is required. In addition, the shape of the fillers does not allow wicking, which can cause corrosion on flange surfaces.

INDUSTRY APPLICATIONS:

- Chemical Processing
- Mining
- Power Generation
- Food & Beverage
- OEM Services
- Pulp & Paper
- General Industry
- Oil & Gas
- Water & Wastewater
- Marine
- Pharmaceutical

Certifications	
USP Class VI	Met requirements for Plastic Class VI - 121°C (250°F)
FDA	Conforms to the requirements of 21 CFR 177.1550 for food and drug contact
ABS-PDA & Pamphlet 95, the chlorine institute, DNV-GL	Approved Material
(EC) 1935/2004 & EU (10/2011)	Approved Material

Gasket Factors	1/16"	1/8"
m	2.2	4.6
Y psi (MPa)	1,937 (13.4)	1,639 (11.3)
G _b psi (MPa)	639 (4.4)	495 (3.4)
a	0.220	0.262
G _s psi (MPa)	55 (0.379)	65 (0.448)

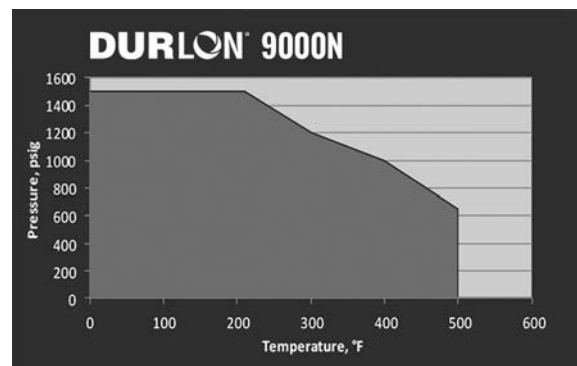

Durlon® 9000N is made with Teflon™ fluoropolymer. Teflon™ is a trademark of The Chemours Company FC, LLC used under license by Triangle Fluid Controls Ltd.

DURLON® 9002

Inorganic Filler with Pure PTFE Resins
Filled PTFE Gasket Material
ASTM F104: F452111-A9B5E11K6M6



Physical Properties

Color	Blue
Filler System	Inorganic
Temperature: Min Max Continuous, Max	-212°C (-350°F) 271°C (520°F) 260°C (500°F)
Pressure, max, bar (psi)	103 (1,500)
Density, g/cc (lbs/ft³)	2.2 (138)
Compressibility, %	8-16
Recovery, %	40
Creep Relaxation, %	30
Tensile Strength, MPa (psi)	13.8 (2,000)
Sealability ASTM 2378 (Nitrogen)	0.01 cc/min
Volume Resistivity, ohm-cm ASTM D257	1.0 x 10 ⁵
Dielectric Breakdown ASTM D149, kV/mm (V/mil)	16 (406)

Gasket Factors	1/16"	1/8"
m	2.2	4.6
Y psi (MPa)	1,937 (13.4)	1,639 (11.3)
G _b psi (MPa)	639 (4.4)	495 (3.4)
a	0.220	0.262
G _s psi (MPa)	55 (0.379)	65 (0.448)

Durlon® 9002 is an adaptation of the original glass-filled formula to better meet extreme cryogenic demands and is readily available through the standard manufacturing process and requires no secondary heat or cleansing treatments prior to gasket cutting. Once gaskets are cut, traditional oxygen cleaning standards must be applied for safety.

Durlon® 9002 comes available as oxygen cleaned gaskets, bagged, labeled, and sealed according to the European Industrial Gases Association standard for Cleaning of Equipment for Oxygen Service.

INDUSTRY APPLICATIONS:

- Chemical Processing
- Marine (LNG)
- Pharmaceutical
- Cryogenic

Certifications

FDA	Conforms to the requirements of 21 CFR 177.1550 for food & drug contact
BAM oxygen service: gaseous & liquid	Up to 260°C (500°F) at 52 bar (754 psi)
LOX Mechanical Impact (ASTM G86 & ISO 21010)	Zero reactions out of 20 at a test reaction frequency of 0%
RoHS Reach Declaration	Compliant



Durlon® 9002 is made with Teflon™ fluoropolymer. Teflon™ is a trademark of The Chemours Company FC, LLC used under license by Triangle Fluid Controls Ltd.

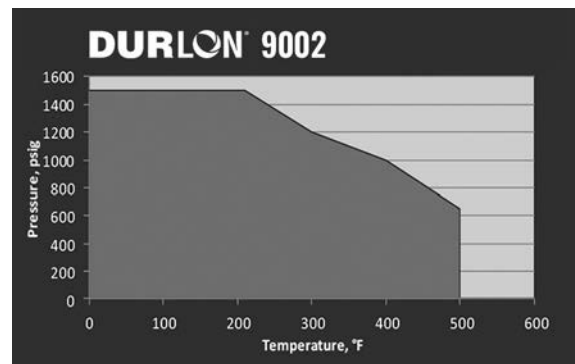

DURLON® 9200

Barium Sulfate Filler with Pure PTFE Resins
Filled PTFE Gasket Material
ASTM F104: F452111-A9B5E11K6M5

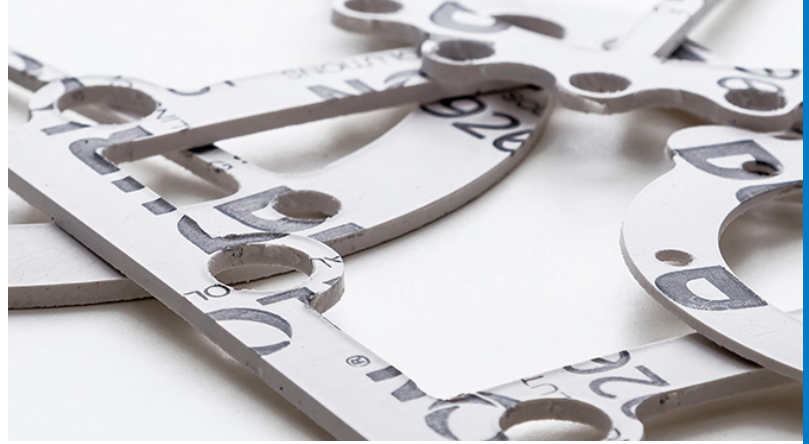

Physical Properties	
Color	Granite White
Filler System	Barium Sulfate
Temperature: Min Max Continuous, Max	-212°C (-350°F) 271°C (520°F) 260°C (500°F)
Pressure, max, bar (psi)	103 (1,500)
Density, g/cc (lbs/ft³)	2.5 (156)
Compressibility, %	8-16
Recovery, %	35
Creep Relaxation, %	30
Tensile Strength, MPa (psi)	13.2 (1,920)
Sealability ASTM 2378 (Nitrogen)	0.01 cc/min
Leakage, mbar .1 (m .5) TA-Luft (VDI 2440) iBar (14.5 psi) @200°C (392°F)	1.89 x 10 ⁻⁵

Durlon® 9200 is a filled PTFE gasket material used where resistance to highly aggressive chemicals is required. Barium sulfate fillers are homogeneously blended with pure PTFE resins to give Durlon® 9200 its physical and mechanical properties. Testing shows the fillers to be more evenly dispersed than filled PTFE with layered construction (HS-10 manufacturing method). The result is more consistent physical and mechanical properties without the voids, separation and chemical compatibility problems found in layered filled PTFE.

INDUSTRY APPLICATIONS:

- Chemical Processing
- OEM Services
- Pulp & Paper
- Food & Beverage
- Oil & Gas
- Rail Tank Car
- General/Heavy Industry
- Petrochemical
- Water & Wastewater
- Marine
- Pharmaceutical
- Mining
- Power Generation

Certifications	
FDA	Conforms to the requirements of 21 CFR 177.1550 for food and drug contact
TA-luft (VDI Guideline 2440)	Approved Material
BAM oxygen service: gaseous & liquid	Up to 260°C (500°F) at 52 bar (754 psi)
ABS-PDA & Pamphlet 95, the chlorine institute, DNV-GL	Approved Material
RoHS Reach Declaration	Compliant

Gasket Factors	1/16"	1/8"
m	1.5	4.2
Y psi (MPa)	952 (6.5)	827 (5.7)
G _b psi (MPa)	153 (1.1)	96 (0.66)
a	0.360	0.437
G _s psi (MPa)	15 (0.1)	14 (0.1)

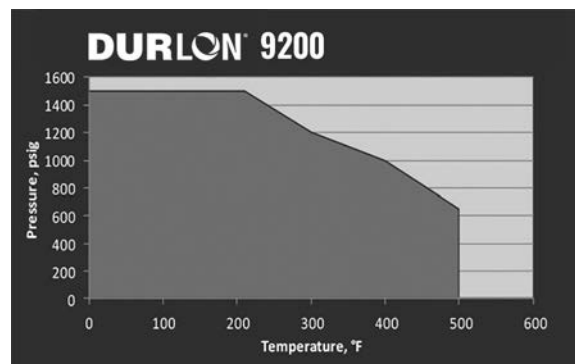

DURLON® 9400

Carbon Filler with Pure PTFE Resins
Filled PTFE Gasket Material
ASTM F104: F452111-A9B5E11K6M6



Physical Properties

Color	Black
Filler System	Carbon
Temperature: Min Max Continuous, Max	-212°C (-350°F) 288°C (550°F) 260°C (500°F)
Pressure, max, bar (psi)	103 (1,500)
Density, g/cc (lbs/ft³)	2.1 (131)
Compressibility, %	5-12
Recovery, %	40
Creep Relaxation, %	30
Tensile Strength, MPa (psi)	14.5 (2,100)
Sealability ASTM 2378 (Nitrogen)	0.01 cc/min
Volume Resistivity, ohm-cm ASTM D257	61
Dielectric Breakdown ASTM D149, kV/mm (V/mil)	1 (33)

Gasket Factors	1/16"	1/8"
m	6.8	-
Y psi (MPa)	2,765 (19.1)	-
G _b psi (MPa)	1,701 (11.7)	1,412 (9.7)
a	0.173	0.164
G _s psi (MPa)	99 (0.68)	248 (1.7)

Durlon® 9400 is a high performance filled PTFE gasket material designed for use in piping and equipment, chemical, and other general industrial applications where resistance to highly aggressive chemicals (including hydrofluoric acid) is required. Durlon® 9400 can also be used as the gasket of choice for anhydrous hydrogen fluoride (AHF) in railroad tank cars and a good alternative for use in plants where barium sulfate filled PTFE may not be suitable.

Hydrogen fluoride is a critical chemical used in many industries, including metal manufacturing and petroleum production. It's also highly reactive and corrosive. Durlon® 9400 carbon-filled PTFE gaskets are built to endure the harshest exposure to hydrogen fluoride. This gasket provides superior sealing properties, and is both highly durable and flexible.

INDUSTRY APPLICATIONS:

- Chemical Processing
- Food & Beverage
- Marine
- Mining
- OEM Services
- Oil & Gas
- Petrochemical
- Pharmaceutical
- Power Generation
- Pulp & Paper
- Rail Tank Car
- Refining
- Water & Wastewater
- General/Heavy Industry

Certifications

RoHS Reach Declaration	Compliant
HFIPI - Materials of Construction Guideline	Approved Material

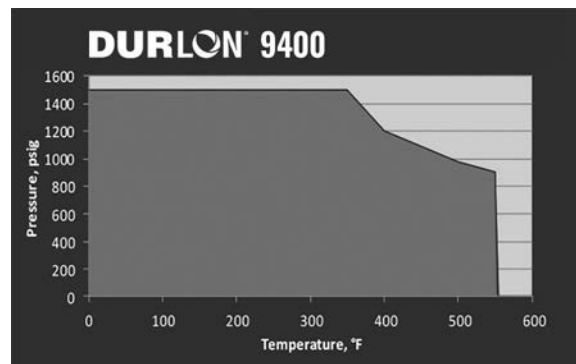

DURLON® 9600

Expanded PTFE
100% Pure PTFE Gasket Material
ASTM F104: F428111-A9B5E11F6M6



Physical Properties	
Color	White
Filler System	Pure PTFE
Temperature: Min Max Continuous, Max	-240°C (-400°F) 316°C (600°F) 270°C (518°F)
Pressure, max, bar (psi)	200 (2,900)
Density, g/cc (lbs/ft ³)	0.9 (56.2)
Compressibility, %	40-50
Recovery, %	14
Creep Relaxation, %	30
Sealability ASTM 2378 (Nitrogen)	0.01 cc/min
Stress Retention-DIN 52913	15 MPa
Specific Leakage Rate L-KD12440/TA-LUFT	2.6 x 10 ⁻⁷
TA-Luft (VDI 2440) Tensile - ASTM 152	20 (2,800)

Gasket Factors	1/16"	1/8"
m	2.0	2.0
Y psi (MPa)	2,800 (19.3)	2,800 (19.3)
G _b psi (MPa)	1,200 (8.3)	1,400 (9.65)
a	0.2	0.19
G _s psi (MPa)	3.5 (0.024)	1.5 (0.01)

Durlon® 9600 is a biaxially expanded PTFE gasket, made with only pure PTFE resins, designed for use in process piping and equipment, in chemical, pulp and paper, food and beverage, and other general industrial applications, where resistance to highly aggressive chemicals is required.

Durlon® 9600 is also suitable for sealing flanges with irregular surfaces. It will not exhibit the cold flow problems associated with virgin PTFE, or the hardness problems of some filled PTFE products. It has excellent sealability, cuts easily and separates cleanly from flanges after use. This material is FDA compliant, ABS-PDA & USP Class VI certified.

INDUSTRY APPLICATIONS:

- Chemical Processing
- Food & Beverage
- General/Heavy Industry
- OEM Services
- Oil & Gas
- Petrochemical
- Refining
- Water & Wastewater

Certifications	
FDA	Conforms to the requirements of 21 CFR 177.1550 for food and drug contact
RoHS Reach Declaration	Compliant
ABS-PDA Certified	Approved Material

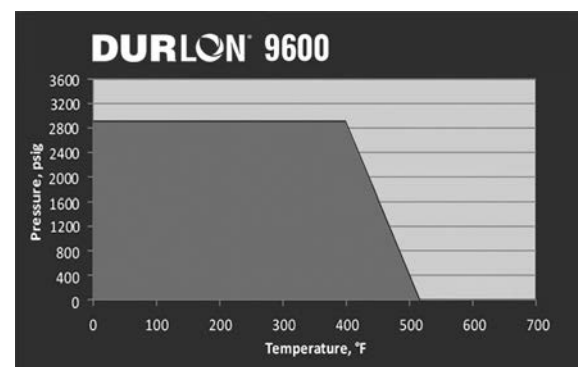

DURLON® Virgin PTFE

100% Pure PTFE Gasket Material



Physical Properties	
Color	White
Material	Skived
Temperature: Min Max	-212°C (-350°F) 260°C (500°F)
Pressure, max, bar (psi)	86 (1,250)
Density, g/cc (lbs/ft ³)	2.1 (135)
Compressibility, %	12-20
Recovery, %	35-40
Creep Relaxation, %	40
Sealability ASTM 2378 (Nitrogen)	0.01 cc/min
Tensile Strength, MPa (psi)	2,800 (19.3)
Color	
Color	White
Material	
Material	Reprocessed
Temperature: Min Max	-212°C (-350°F) 260°C (500°F)
Pressure, max, bar (psi)	86 (1,250)
Density, g/cc (lbs/ft ³)	2.1 (135)
Compressibility, %	18-25
Recovery, %	30-35
Creep Relaxation, %	50
Sealability ASTM 2378 (Nitrogen)	0.015 cc/min
Tensile Strength, MPa (psi)	1,500 (10.3)

Durlon® Virgin PTFE gasket material is a high performance PTFE product designed for use in piping and equipment in chemical and other general industrial applications where resistance to highly aggressive chemicals (including hydrofluoric acid) is required.

Virgin PTFE sheet material is available in two grades:
SKIVED

- has better physical properties
- is a good electrical insulator
- FDA approved

REPROCESSED

- recycled PTFE processed into skived or molded sheet

Durlon® Virgin PTFE is made with only pure PTFE resins. It has excellent sealability characteristics, cuts easily and separates cleanly from flanges after use. Durlon® Virgin PTFE demonstrates high dielectric strength.

INDUSTRY APPLICATIONS:

- Chemical Processing
- Food & Beverage
- Pharmaceutical

Certifications	
FDA	Conforms to the requirements of 21 CFR 177.1550 for food and drug contact (Applies to Skived grade only)
RoHS Reach Declaration	Compliant

DURLON® Joint Sealant

100% Pure Expanded PTFE Gasket Material



Physical Properties	
Color	White
Temperature: Min Max	-268°C (-450°F) 316°C (600°F)
Density, g/cc (lbs/ft ³)	0.9 (56.2)
Compressibility, %	40-60
Creep Relaxation, %	25
Sealability ASTM 2378 (Nitrogen)	0.05 cc/min
Pressure, max, bar (psi)	200 (2,900)

Durlon® Joint Sealant (PTFE Adhesive) is a highly fibrillated expanded PTFE form-in-place sealant for gasketed joints and conforms to FDA requirements.

Supplied on spools, Durlon® Joint Sealant comes in various thicknesses with a high quality adhesive backing to ease in installation; making it ideal for worn flanges of all sizes and is not dependent on flange dimensions. It exhibits flexibility, compressibility, and stability under high temperature while maintaining high tensile strength. Another feature of Durlon® Joint Sealant is its chemically inert properties which resists creep relaxation, resulting in the maintenance of a tight seal.

Durlon® Joint Sealant is made with only 100% pure PTFE resins and exhibits the same chemical resistance of virgin PTFE.

Recommended Usage	(Width x Thickness)
2" - 4"	1/4" x 3/32" (0.098")
5" - 8"	3/8" x 1/8" (0.118")
10" - 16"	1/2" x 5/32" (0.158")
18" - 24"	5/8" x 7/32" (0.236")
26" - 48"	3/4" x 9/32" (0.276")
48" and higher	1" x 3/16" (0.197")

INDUSTRY APPLICATIONS:

- Chemical Processing
- Food & Beverage
- Marine
- Petrochemical
- Pharmaceutical

Certifications	
FDA	Conforms to the requirements of 21 CFR 177.1550 for food and drug contact
RoHS Reach Declaration	Compliant

DURLON® RCA®

Reduced Contact Area Full Face Gasket PTFE & Compressed Non-Asbestos Gasket Material

RCA® is a registered trademark of Gasket Resources Inc.

AVAILABLE MATERIALS: 1/16" & 1/8" Durlon® PTFE styles and 1/16" compressed asbestos-free styles

AVAILABLE SIZES: 1-24" Class 150 Full Face gaskets

- For FRP, PVC, Glass-Lined or steel flanges where a low stress gasket is required
- Reduced contact area
- Lower sealing stress
- Significant cost savings
- Alignment guides included for easy positioning during installation
- Identification tabs extend beyond the flange OD for easy identification once bolted



Durlon® RCA® sealing system combined with Durlon® PTFE styles can replace standard full gaskets in FRP, PVC and other non-metallic and metallic pipe flanges where a low stress gasket is required. The RCA® configuration can be cut from standard PTFE & CNA sheets resulting in a cost savings versus other low stress gaskets.

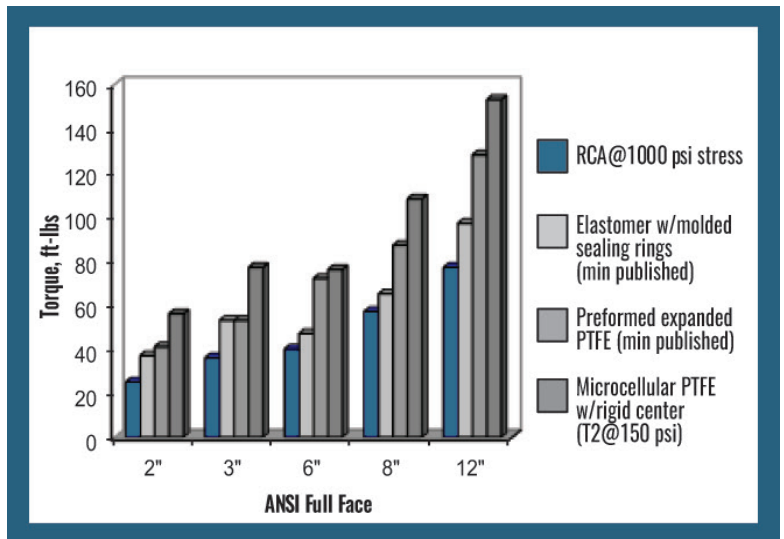
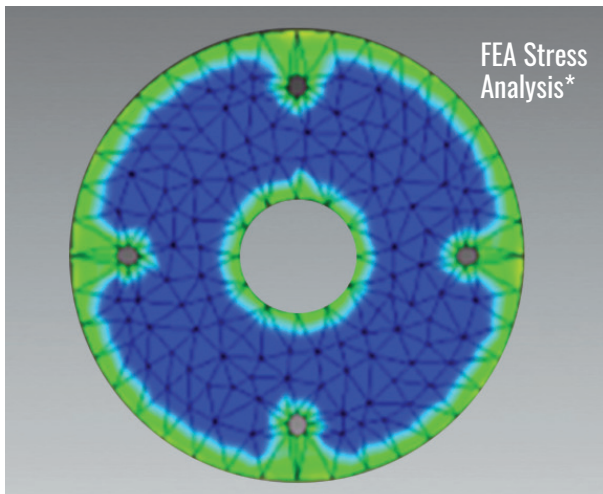
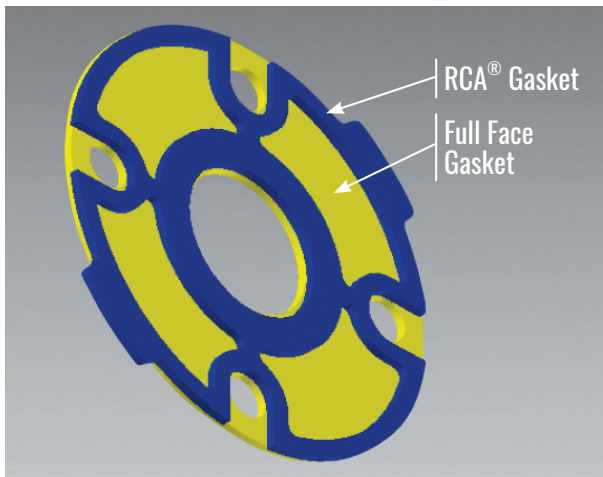

The above illustrates a 3" 150# Full Face gasket using FEA analysis to show the applicable stresses that are being applied to the gasket while bolted up in the flange. The gradual shades of grey (from light to dark) show stress intensity. Blue indicates very little or no stress is being applied at all to those areas of the gasket.

Certifications

Certification applies to gasket material used

DURLON® CFG

Corrugated Flexible Graphite Gasket

Physical Properties	
Temperature: Min	-200°C (-328°F)
Max	650°C (1,200°F)
Continuous, Max	550°C (1,022°F)
pH range, Room Temp.	0-14
Pressure: Max, bar (psi)	207 (3,000)

Gasket Factors	
G _b psi (MPa)	557 (3.84)
a	0.325
G _s psi (MPa)	2.21 (0.015)
m	2.6
Y psi (MPa)	3770 (26.0)

ADVANTAGES:

- Recovery/Spring-Back characteristics for excellent sealing and thermal cycling
- Blowout Resistant - Metal core counteracts internal pressure spikes
- Superior Emissions Control - Nitrogen Sealability (ASTM F2378) <0.01 cc/min
- Easy to handle, easy to install
- Seals tightly with lower bolt loads vs. spiral wounds



Durlon® CFG is a corrugated flexible graphite gasket material designed for severe service conditions. The proprietary design of the corrugations gives Durlon® CFG superior sealing and recovery characteristics for tough conditions in the refining, chemical, petrochemical, and pulp & paper industries. Durlon® CFG is suitable for service in steel, oil, mild alkalis, mild acids, hydrocarbons, and solvents.

Durlon® CFG consists of flexible graphite laminated with an adhesive bond on both sides of a corrugated 316 stainless steel core. For consolidation of inventories and applications standardization: Durlon® CFG is available for all applications in 3/32” (2.4mm) thickness. (1/16” and 1/8” thickness is also available.)

INDUSTRY APPLICATIONS:

- Water & Wastewater
- Oil & Gas
- Mining
- Food & Beverage
- OEM Services
- Petrochemical
- Power Generation
- General Industrial
- Marine
- Chemical Processing
- Pulp & Paper

Certifications	
Fire Test	API 607
RoHS Reach Declaration	Compliant

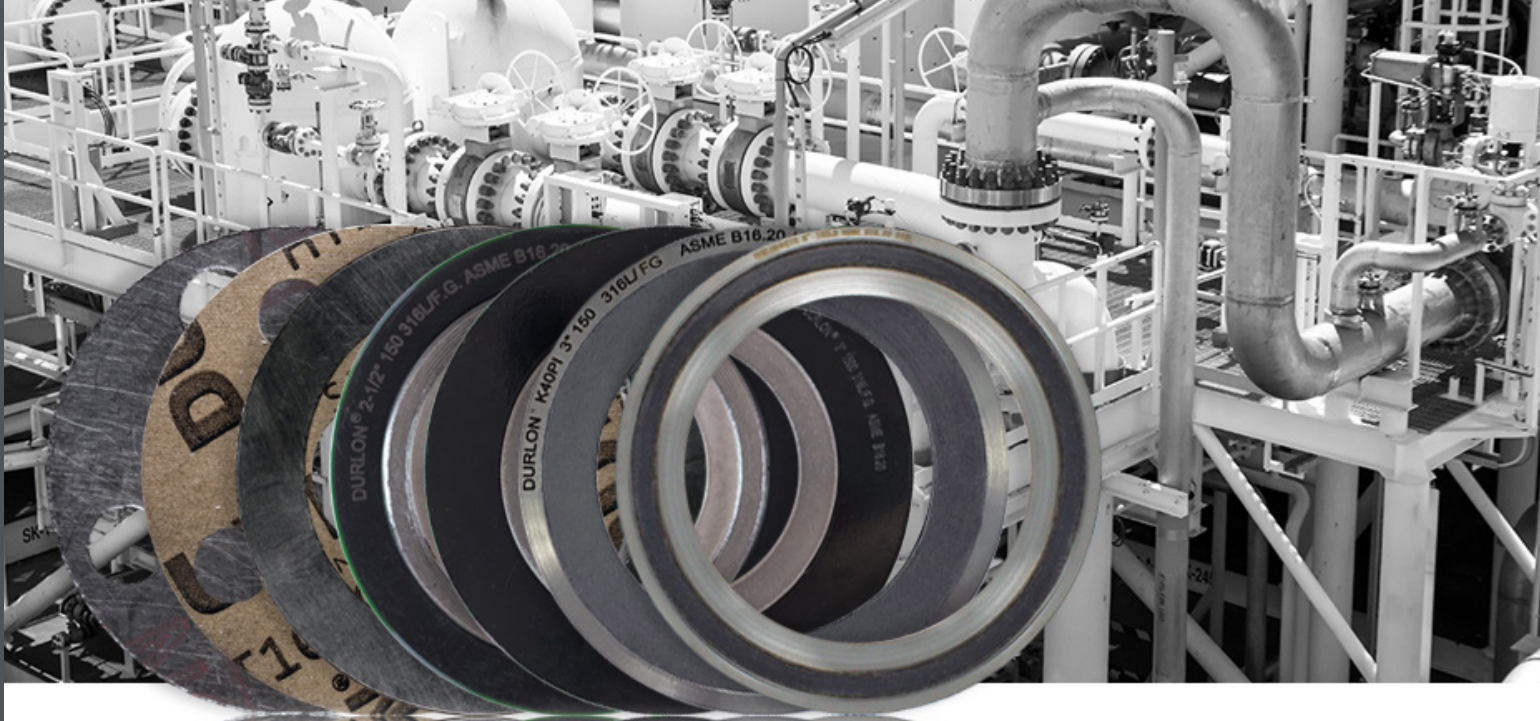

Metallic & Semi-Metallic Gasketing

Durlon® metallic gaskets are manufactured from a combination of metals and designed to withstand extreme temperatures, pressures and chemical exposure. Available in standard and custom configurations, these rugged metal gaskets are made of a wide range of materials to accommodate all types of process applications. Commonly used metallic gaskets are our ring-type-joint (RTJ) style. These gaskets are designed to work by "initial line contact" or a wedging action between the flange and the gasket.

Durlon® semi-metallic gaskets include both metallic and non-metallic components, either containing a metal core with sealing materials on both flat surfaces, or a pliable core encased in a thin metallic casing. These configurations are most popular, and available in a wide variety of styles and sizes. They can typically be fabricated of any metal which is available in thin strip or sheet, and that can be welded. Therefore, they can be used against virtually any corrosive medium dependent upon the choice of the metal and filler or facing material.

Our computer-aided manufacturing process uses rigorous quality control programs to ensure premium quality product performance. The metallic component gives the gasket superior structural integrity, while the non-metallic element ensures superior

sealing. To be able to achieve an effective seal, proper gasket selection must occur with metallic gaskets. The following elements must be considered when determining the correct gasket for the application.

TEMPERATURE

Most gaskets consist of two or more components or ingredients. The overall temperature resistance of a gasket is determined through analysis of the upper and lower limits for each component. There are two parts that need to be considered and verified when selecting the correct gasket material. The first part is to verify the metal component used to ensure the maximum temperature for the material is not exceeded. Secondly, the maximum temperature rating for the filler or facing material must be verified to ensure it is not exceeded. In most cases the filler or facing material will be the sacrificial element and will be the governing factor when selecting a semi-metallic gasket.

CHEMICAL COMPATIBILITY

The gasket must be resistant to chemical corrosion or chemical attack. The rate of corrosion is dependent on the time, temperature, and concentration of the media and must be considered when selecting both the gasket metallurgy and filler or facing material. For chemical resistance information of metals and semi-metallic gaskets, see pages 67- 74.

FLANGE COMPATIBILITY

The flange itself must be designed so that it can apply a sufficient amount of clamping force to ensure the flange serrations are biting into, or seating the gasket. Flange materials also need to be verified against the specified metallurgy in semi-metallic gaskets. If left unverified, it is possible for galvanic type corrosion to occur due to dissimilar metals. In the use of RTJ gaskets, the gasket must deform enough to create an effective seal. If the material of the gasket is harder than the flange, it will damage the flange; hence the material hardness is critical when dealing with RTJ flanges and gaskets.

GASKET SEATING STRESS

The gasket seating stress is the minimum force required to compress the gasket so that it forms an effective seal while resisting the blowout or internal pressure of the system. Seating stress must also be taken into consideration with both the gasket type and flange surface finish. The minimum and maximum seating stresses are product specific and recommended by the manufacturer, the table below shows the recommended minimum and maximum stresses for Durlon® metallic gasketing products.

Gasket Type/Style	Minimum Gasket Stress (1,3)		Maximum Gasket Stress (3)	
	psi	bar	psi	bar
Graphite Sheet	1,000 - 2,000	68.95 - 137.90	10,000 - 24,000	689.5 - 1,655
Premium Machined-core Gasket (Durtec)	2,500 - 4,000	172.40 - 275.80	15,000 - 35,000	1,034 - 2,413
Kammprofile (Grooved Metal Gaskets with Covering Layers)	2,500 - 4,000	172.40 - 275.80	35,000 - 40,000	2,413 - 2,758
Corrugated Gaskets (CFG)	4,000 - 5,000	275.80 - 344.70	30,000	2,068
Low Stress Spiral Wound Gasket	5,800	379.20	30,000 - 35,000	2,068 - 2,413
Spiral Wound Gasket	7,500 - 10,000	517.10 - 689.50	30,000 - 40,000 (2)	2,068 - 2,758
*HT1000®	(5)		30,000	2,068
Ring Type Joint (RTJ)	(6)	-	35,000 - 40,000 (2)	2,413 - 2,758

*HT1000® is a registered trademark of Triangle Fluid Controls Ltd.

NOTES:

1. Minimum gasket stresses shown do not necessarily ensure any specific level of leak tightness. They generally reflect minimum seating stresses found in published documents. Specific manufacturer's data may fall outside of this range.
2. Maximum gasket stress shown may be dependent upon gasket materials used.
3. The gasket stresses shown above are not specific to any given leak tightness class (ie. T1, T2, T3, etc.)
4. Maximum gasket stress based on gasket diameter.
5. Contact tech@trianglefluid.com or tech@durlon.com with application specific details.
6. Minimum seating stress based on ring material selected.

DURLON® Flexible Graphite

Homogeneous, 316SS Foil Insert
316SS Tang Insert, 316SS Multilayer



Nominal Thickness*	Sheet Sizes	
	in.	mm
1/32" (0.8mm)	39.4 x 39.4	1,000 x 1,000
	59.1 x 59.1	1,500 x 1,500
1/16" (1.5mm)	39.4 x 39.4	1,000 x 1,000
	59.1 x 59.1	1,500 x 1,500
1/8" (3.0mm)	39.4 x 39.4	1,000 x 1,000
	59.1 x 59.1	1,500 x 1,500

*More thicknesses available by special order, depending on material.



FGS95: Standard industrial grade sheet containing no binders or resins. Mainly used in industrial applications such as oil refineries, power plants and chemical process plants.

Durlon® Flexible Graphite is unaffected by heat over a wide range of temperatures. It exhibits low electrical resistivity and high thermal conductivity and is suitable for cryogenic temperatures and is available in several styles.

These include homogeneous sheet and laminated styles with various types of core materials. Durlon® Flexible Graphite can also be special ordered with various inhibitors, grades of graphite, and core materials to suit specific critical applications.

INDUSTRY APPLICATIONS:

- Chemical Processing
- General Industry
- OEM Services
- Oil & Gas
- Petrochemical
- Power Generation
- Refining

CHARACTERISTICS AND BENEFITS:

- Impermeable to gases and liquids
- Suitable for service over a wide range of pressures and temperatures
- Resists thermal shock
- Maintains excellent sealability
- Does not age, shrink or harden
- Seals easily under low to moderate bolt loads
- High chemical resistant

FGS95 - Physical Properties	
Temperature: Min	-260°C (-450°F)
Max, in air	454°C (850°F)
Max, in steam	650°C (1,200°F)
Pressure, max, bar	207 (3,000 psi)
Compressibility, % ASTM F36	35-40
Recovery, % ASTM F36	20
Creep Relaxation, % ASTM F36	5
Ignition Loss, % @ 454°C (850°F) @ 650°C (1200°F)	1 8
Sealability, ASTM F2378	0.4 cc/min
ASTM F104 & F868 Line Call Outs	F104-F517000B1M3
Carbon Content	≥ 98%



FGL316: Standard industrial grade sheet laminated with an adhesive bond on both sides of a 0.002” thick 316 stainless steel foil core. This product is used where high performance and handling are important.

FGL316 - Physical Properties	
Temperature: Min	-260°C (-450°F)
Max, in air	454°C (850°F)
Max, in steam	650°C (1,200°F)
Pressure, max, bar	207 (3,000 psi)
Compressibility, % ASTM F36	35-40
Recovery, % ASTM F36	18
Creep Relaxation, % ASTM F36	5
Ignition Loss, % @ 454°C (850°F)	1
@ 650°C (1200°F)	6
Sealability, ASTM F2378	0.4 cc/min
ASTM F104 & F868 Line Call Outs	F868-9FMF2
Carbon Content	≥ 98%



FGT316: Standard industrial grade sheet mechanically bonded on both sides of a 0.004” thick 316 stainless steel tang core. This product is used where stresses and pressures are high and improved handling is important.

FGT316 - Physical Properties	
Temperature: Min	-260°C (-450°F)
Max, in air	454°C (850°F)
Max, in steam	650°C (1,200°F)
Pressure, max, bar	207 (3,000 psi)
Compressibility, % ASTM F36	35-40
Recovery, % ASTM F36	20
Creep Relaxation, % ASTM F36	5
Ignition Loss, % @ 454°C (850°F)	1
@ 650°C (1200°F)	6
Sealability, ASTM F2378	0.8 cc/min
ASTM F104 & F868 Line Call Outs	F868-9FMF1
Carbon Content	≥ 98%



FGM316: Inhibited grade sheet laminated with multiple layers of 0.004” thick 316 stainless steel foil core. This product is used in applications with high mechanical stress or pressure, above average burst resistance, exceptional rigidity, and suitable to cut gaskets with narrow strips.

FGM316 - Physical Properties	
Temperature: Min	-260°C (-450°F)
Max, in air	550°C (1,022°F)
Max, in steam	650°C (1,200°F)
Pressure, max, bar	250 (3,625 psi)
Compressibility, % ASTM F36	30-40
Recovery, % ASTM F36	10-15
Creep Relaxation, % ASTM F36	5
Ignition Loss, % @ 454°C (850°F)	<1
@ 650°C (1200°F)	<3
Sealability, ASTM F2378	0.4 cc/min
ASTM F104 & F868 Line Call Outs	F868-9FMF2
Carbon Content	≥ 98%

DURLON®

HT1000®

Phlogopite Mica with Silicone Binder S90, L316, T316

HT1000® is a registered trademark of Triangle Fluid Controls Ltd.



Physical Properties

Color	Metallic Gold
Fiber System	Phlogopite Mica, 90% min.
Binder	Silicone
Temperature: Min Max	-55°C (-67°F) 1,000°C (1,832°F)
Pressure, max, psi (bar) Style S90 Styles L316/T316	5.5 (80) 40 (580)
Density, g/cc (lbs/ft³)	1.7 (106)
Compressibility, % ASTM F36	18-22
Recovery, % ASTM F36J	39-43
Creep Relaxation, % ASTM F38	55
Tensile Strength across grain ASTM F152, MPa (psi)	29.6 (4,300)
Ignition Loss, % @ 800°C	<4
Nitrogen Sealability, ASTM F2378	8 cc/min
Dielectric Breakdown, kV/mm (V/mil) ASTM D149	20 (508)

Durlon® HT1000® consists of phlogopite mica paper impregnated with an inorganic binder at less than half the binder amount found in vermiculite-phyllsilicate filled products. This lower binder content allows for superior weight retention, less than 4% weight loss at 800°C (1,472°F), and results in ultimate extreme temperature sealing performance up to 1,000°C (1,832°F). Durlon® HT1000® characteristics allow for it to be used as a sealing material on its own or combined with various carrier media in heat exchangers, exhaust manifolds, and other equipment commonly found in the refinery, power generation, and chemical industries.

Phlogopite mica is a non-toxic naturally occurring hydrated silicate of potassium and magnesium with a lamellar and non-fibrous structure. It is flexible, has a high tensile strength, can withstand substantial mechanical pressure perpendicular to the lamellar plane, is chemically resistant, fireproof, infusible, incombustible, non-flammable, and is a known alternative to asbestos.

INDUSTRY APPLICATIONS:

- General Industry
- Marine
- Mining
- OEM Services
- Petrochemical
- Power Generation
- Refining

Certifications

Fire Test	API 607, 4th edition with Exxon modifications
-----------	---

Durlon® HT1000® sheets and cut gaskets are available in 3 sheet forms:

S90: Phlogopite mica paper impregnated with an inorganic binder and no carrier.

L316: Phlogopite mica paper impregnated with an inorganic binder laminated with a 0.002" thick 316 stainless steel carrier.

T316: Phlogopite mica paper impregnated with an inorganic binder laminated with a 0.004" thick 316 stainless steel perforated carrier.



S90



L316



T316

DURLON[®] HT1000[®] Paste

High Temperature Sealing Compound

HT1000[®] is a registered trademark of Triangle Fluid Controls Ltd.



Physical Properties	
Temperature: Min Max	260°C (500°F) 1,000°C (1,832°F)
Curing Temperature	Required Cure Time
149°C (300°F)	4 Hrs
204°C (400°F)	3 Hrs
260°C (500°F)	2 Hrs
316°C (600°F)	1 Hr
371°C (700°F) or Higher	<1 Hr

Note: In high pressure gasket sealing applications or if ambient pressure testing is being performed, it is recommended that the HT1000[®] Paste be pre-cured with a heat source such as a heat gun or oven if available prior to putting the gasket into pressurized service.

Durlon[®] HT1000[®] Paste is a sealing compound designed to be used in conjunction with our HT1000[®] sheet material specifically for large dovetail gaskets. The paste allows end users to create larger diameter gaskets using cost effective dovetail gasket segments. The HT1000[®] Paste allows end users to eliminate possible leak paths of traditional dovetail gaskets, while providing end users the one piece gasket construction and lower leakage rates similar to one-piece gasket.

Available in 170 g and 90 g containers.

SHELF LIFE:

6 months in unopened container from the date it was packaged.

INSTRUCTIONS:

1. Make sure gasket segments are aligned and laying flat pre-assembled. Ensure that both the gasket and flange are free of debris, oils, and grease.
2. Open container of HT1000[®] Paste and apply a thin, even layer to the dovetail portion of the gasket, using a disposable brush or putty knife, smoothing out any uneven portions.
3. Assemble flange and tighten bolts according to gasket manufacturer's recommendations (torque, bolt-up method, etc.).
4. HT1000[®] Paste will begin to cure in service (Please see applicable curing time chart to left).

DURLON® Durtec®

Specially Engineered Metal Core Technology

Durtec® is a registered trademark of Triangle Fluid Controls Ltd.



Physical Properties*

Temperature: Min	-200°C (-328°F)
Max	1,000°C (1,832°F)
Continuous, Max	650°C (1,200°F)
pH range, Room Temperature	0-14
Pressure: Max, bar (psi)	430.9 (6,250)

*Depends on facing material and metallurgy of core.
Note: Data shown is for 316LSS core with HT1000 covering layers.

SIZE, TYPES & MATERIALS:

- Standard ASME, DIN, JIS and BS EN sizes
- Non-standard flanges 1/2” through 157” diameter
- Standard core material is 316L stainless steel. Other core materials: SS304, SS321, SS316Ti, Monel®, Titanium, Hastelloy® & Alloy 20 can be manufactured to your specifications on request
- Alternate facing material is available upon request. Popular materials include Durlon® 9600 expanded PTFE (ePTFE), mica & ceramic

API 607 FIRE TEST:

- Average bolt torque loss (with no adjustments):
Upstream 45%; Downstream 33%
- Fire, Cool-Down & Post-Burn: Combined Leak Rate (2 gaskets) 0 mL/min at 30 psig avg.
- Exxon requirements post burn: Combined Leak Rate (2 gaskets) with no flange bolt re-torques at any test pressure 0 mL/min at 30 psig, 0mL/min at 50 psig, 0 mL/min at 100psig and, 0mL/min at 200 psig.

**Passed modified API 607 fire test and meets the requirements of Shell Specification MESC SPE 85/203 & PVRC SCR Flexible Graphite Spec for FG 600 material.

Durlon® Durtec® gaskets are made with a specially engineered machined metal core that is bonded on both sides with soft covering layers, typically flexible graphite. The core is produced by proprietary technology that allows the finished gasket to have the best possible mechanical support function. The Durtec® core is virtually uncrushable, unlike conventional corrugated metal core gaskets. The precision construction guarantees that Durlon® Durtec® gaskets will have excellent sealing characteristics even under low bolt loads.

The Durtec® gasket is designed to withstand high temperatures and pressures, to be blowout resistant, to be fire safe, and to resist toxic and or corrosive chemicals for such applications as: pipeline flanges, valves, small & large pressure vessels, heat exchangers, towers, and tanks.

INDUSTRY APPLICATIONS:

- Water & Wastewater
- Oil & Gas
- Mining
- Food & Beverage
- OEM Services
- Petrochemical
- Power Generation
- General Industrial
- Marine
- Chemical Processing
- Pulp & Paper

Gasket Factors

G _b psi (MPa)	187 (1.29)
a	0.467
G _s psi (MPa)	0.5 (0.003)
m, Y psi (MPa)	1.5, 833 (5.74)

Certifications

Fire Test**	API 607, 4th edition with Exxon modifications
RoHS Reach Declaration	Compliant

COMMON HEAT EXCHANGER SHAPES

There are many styles of heat exchanger gaskets and most have complicated rib designs or partitions. While some of the most common designs are shown below, we can provide almost any configuration of heat exchanger type gasket utilizing our Durlon® Durtec® technology.

- Anywhere fire safety is a concern
- High temperature
- Low available assembly loads

- Heavy vibrations
- Extreme temperature fluctuations
- Remote field applications
- Large diameter gasket replacement

ADVANTAGES:

- **Fire Safe** - SS316L/Graphite Passed Modified API 607 fire test, 4th Edition
- **Blowout Resistant** - Metal core provides excellent resistance to internal pressure spikes

- **Reusable** - The core may be refaced with new material and reused providing lower cost of ownership
- **Superior Core Technology** - Durtec® design can allow for complete replacement of spiral wound and kammprofile gaskets with improved performance and lower life cycle cost
- Easy and safe to handle, easy to install
- Seals tightly with lower bolt loads vs. spiral wounds and Kammprofiles

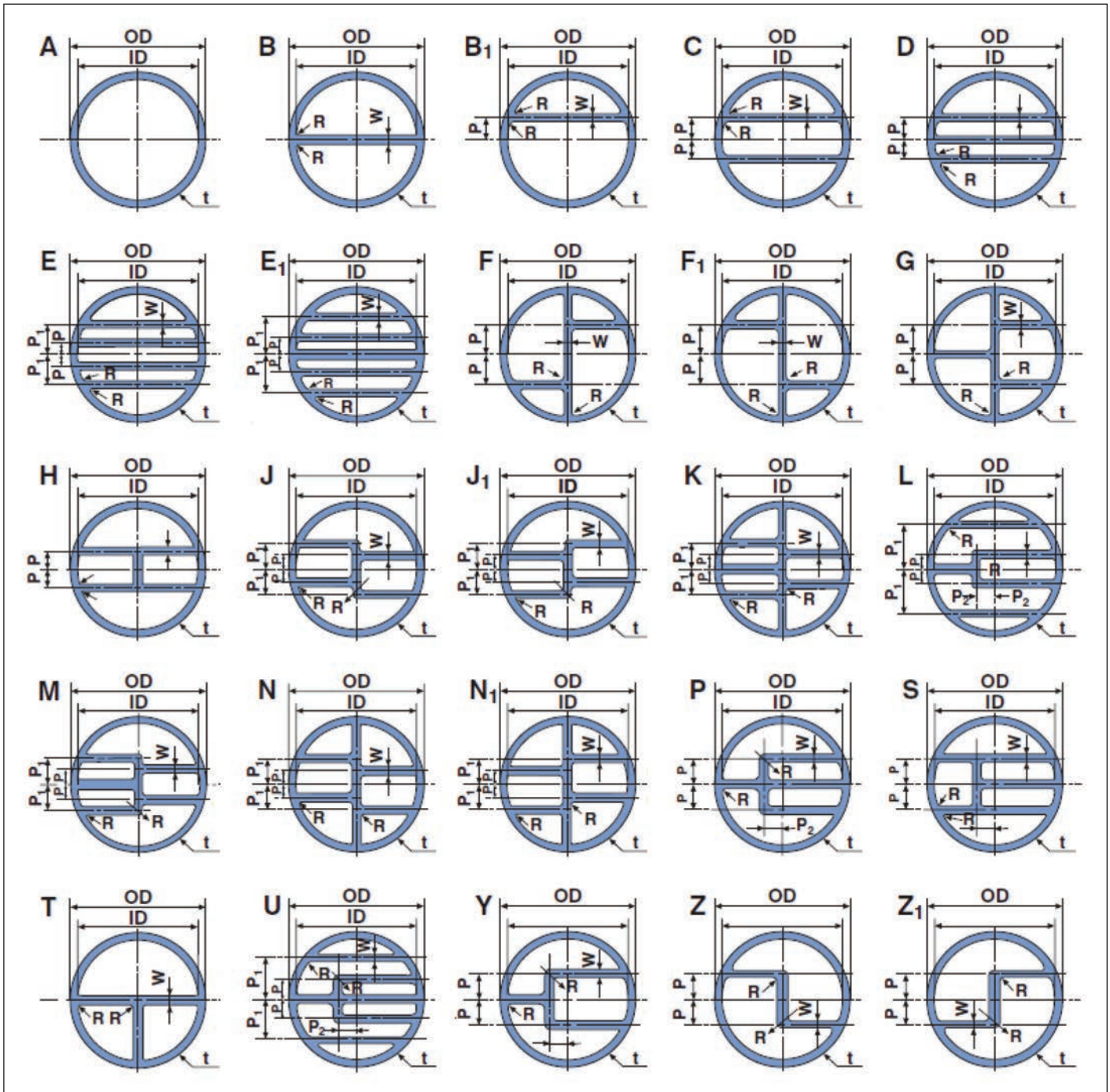

DURLON® SWG

Spiral Wound Gaskets
Style: D, DR & DRI
ASME B16.20 Standards



Gasket Factors	G_b psi (MPa)	a	G_s psi (MPa)
Type D, DR, DRI Graphite	86 (0.593)	0.594	0.1 (0.0001)
Type D, DR, DRI ETG	90 (.620)	0.590	0.1 (0.0001)
Type D, DR, DRI PTFE	173 (1.19)	0.405	1.0 (0.0007)

m & Y Factors	m	Y psi
Type D, DR, DRI Graphite, ETG & PTFE	2.8	5,800

Durlon® Spiral Wound Gaskets are made with an alternating combination of a preformed engineered metal strip and a more compressible filler material which creates an excellent seal when compressed. The engineered shape of the metal strip acts as a spring under load, resulting in a very resilient seal under varying conditions. The strip metallurgy and filler material can be selected to seal a wide range of applications. All Class 150 & 300 Durlon® SWG styles have been engineered to precise manufacturing tolerances and utilize optimal winding density that allow for lower stress (bolt load) sealing compared to conventional spiral wound gaskets thus eliminating the need to stock both standard and low stress SWG's.

All Durlon® SWG's are manufactured according to ASME B16.20 standards. Quality Assurance complies with API Specifications Q1 and ISO 9001 standards. Super Inhibited Graphite meets the requirements of Shell Specification MESC SPE 85/203 and meets PVRC SCR Flexible Graphite Spec for FG 600 material.

Durlon® SWG's obtain their initial seal with very low seating stresses and provide a tighter seal than typical low stress spiral wound gaskets and other high temperature alternative gaskets. Our advanced manufacturing process allows all Durlon® SWG's to perform better under low bolt stress applications while maintaining seal integrity under normal conditions.

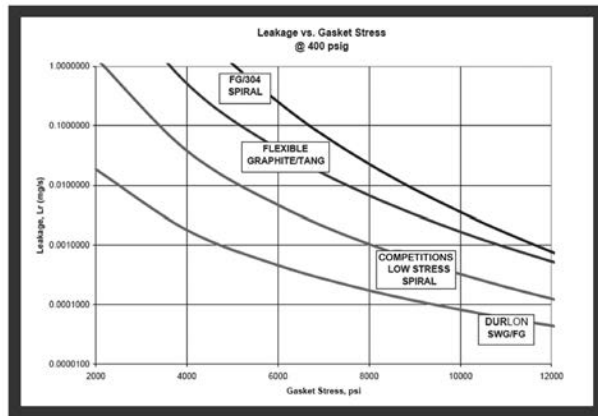

INDUSTRY APPLICATIONS:

- Oil & Gas
- Petrochemical
- Chemical Processing
- Mining
- Power Generation
- Pulp & Paper
- Food & Beverage
- Heavy Industrial

Durlon® Style DR and DRI gasket centering rings (in carbon steel) are coated to inhibit atmospheric corrosion. Durlon® Spiral Wounds are packaged with the utmost care to prevent damage during shipping to the job site.

Certifications

Styles D, DR & DRI	TA Luft (VDI 2440)
6 inch Class 300 SWG FG	API Standard 6FB Fire Test

DURLON® SWG

Spiral Wound Gaskets
Style: D, DR & DRI
ASME B16.20 Standards

Style D

- Sealing element only consisting of preformed engineered metal and more compressible filler material
- Commonly used in tongue & groove or male & female flanges
- Can also be supplied with an inner ring as Style DI (Inner ring with winding and no center ring)

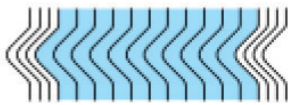

Style DR

- Sealing element (D) combined with a centering ring (R) which reinforces the gasket and acts as a compression stop
- Commonly used with standard Raised Face and Full Face type flanges
- Centering ring is epoxied which provides superior corrosion resistance compared to powder or liquid coating



Style DRI

- Sealing element (D) combined with a centering ring (R) and an inner ring (I) which improves radial strength and protects the sealing element from erosion and inward buckling
- Commonly used with standard Raised Face, Full Face type flanges and worn RTJ flange replacement gaskets
- Inner rings are recommended for all spiral wound gaskets but are mandatory (ASME B16 20-2007) for all PTFE filled gaskets, NSP 24" and larger Class 900. NSP 12", larger Class 1500 and NSP 4" and larger Class 2500



Metallurgy				Guide Ring Color Code
Material	Minimum °F °C	Maximum °F °C	Abbreviation	
304 Stainless Steel	-320 -195	1,400 760	304	YELLOW
316L Stainless Steel	-150 -100	1,400 760	316L	GREEN
317L Stainless Steel	-150 -100	1,400 760	317L	MAROON
321 Stainless Steel	-320 -195	1,400 760	321	TURQUOISE
347 Stainless Steel	-320 -195	1,700 925	347	BLUE
Carbon Steel	-40 -40	1,000 540	CRS	SILVER
20Cb-3 (Alloy 20)	-300 -185	1,400 760	A-20	BLACK
HASTELLOY® B2	-300 -185	2,000 1,090	HAST B	BROWN
HASTELLOY® C 276	-300 -185	2,000 1,090	HAST C	BEIGE
INCOLOY® 800	-150 -100	1,600 870	IN 800	WHITE
INCOLOY® 825	-150 -100	1,600 870	IN 825	WHITE
INCONEL® 600	-150 -100	2,000 1,090	INC 600	GOLD
INCONEL® 625	-150 -100	2,000 1,090	INC 625	GOLD
INCONEL® X750	-150 -100	2,000 1,090	INX	NO COLOR
MONEL® 400	-200 -130	1,500 820	MON	ORANGE
Nickel 200	-320 -195	1,400 760	NI	RED
Titanium	-320 -195	2,000 1,090	TI	PURPLE

Filler Materials				Stripe Color Code
Material	Minimum °F °C	Maximum °F °C	Abbreviation	
Ceramic	-350 -212	2,000 1,090	CER	LIGHT GREEN
Flexible Graphite	-350 -212	950 510	F.G.	GRAY
PTFE	-400 -240	500 260	PTFE	WHITE
Phyllosilicate	-67 -55	1,800 1,000	ETG	LIGHT BLUE

DURLON® Kammprofile

Serrated Flat Metal Gaskets Grooved metal gasket with covering layers



Physical Properties

Temperature:	
Min	-200°C (-328°F)
Max (material dependent)	1,000°C (1,832°F)
Pressure, max, bar (psi)	414 (6,000)
pH range, Room Temp	0-14

CORE MATERIALS:

- Standard core material is 316 stainless steel with a nominal thickness of 0.125" (3mm)
- Other core materials and thicknesses are available to suit specific applications
- Core material is generally selected in an identical material to the piping system in order to reduce corrosion problems

FACING MATERIALS:

- Standard facing material is flexible graphite with a nominal thickness of 0.020" (0.5mm)
- Other facing materials and thicknesses are available to suit specific applications
- Meets Shell Specification MESC SPE 85/203 & PVRC SCR Flexible Graphite Spec for FG 600 material

SHAPES:

- Round, ovals (normal or irregular), manways, track shapes, diamonds, squares/rectangles, with ribs, etc.

FLANGE SURFACE FINISH:

- The ideal flange surface finish for use with Kammprofile gaskets is 125-250

Gasket Factors

m, Y psi (MPa)	4.00, 1,000 (6.89)
----------------	--------------------

Durlon® Kammprofile gaskets have a solid metal core with concentrically serrated grooves machined into the top and bottom faces. The metal core is typically stainless steel, but it can be supplied in various metallurgies as per the customer's request.

The serrated core is covered with soft sealing material and is dependent on the service conditions of the system. Flexible graphite and expanded PTFE sealing layers are most common, but other products like HT1000® or (Extreme Temperature Gaskets) ETG's can be used as well. While providing the Durlon® Kammprofile gasket with excellent sealing properties, the soft sealing layers also fill in minor flange imperfections and protect the flange surfaces from damage.

Durlon® Kammprofile gaskets are the preferred choice for applications requiring improved performance at low seating stresses. The serrated peaks provide reduced contact area and when combined with the soft conformable sealing layers, the Durlon® Kammprofile gasket provides a virtual metal-to-metal connection. They feature excellent resistance to blowout and provide superior stability for ease of handling and installation.

INDUSTRY APPLICATIONS:

- Oil & Gas
- Mining
- Petrochemical
- Power Generation
- Heavy Industrial
- Chemical Processing
- Pulp & Paper

Certifications

RoHS Reach Declaration	Compliant
------------------------	-----------

DURLON® ETG

Extreme Temperature Gaskets SWG/Durtec®/Kammprofile

Durlon® Extreme Temperature Gaskets (ETG) have been engineered to provide the preeminent solution to sealing gasketed joints having exposure to high temperatures, typically greater than 650°C (1,200°F) and up to 1,000°C (1,832°F). At extreme temperatures, flange assembly torque retention is the key component to maintaining a tight seal. Durlon® ETG combines an oxidation boundary material with the excellent stability and sealing characteristics of flexible graphite in order to preserve seal integrity and to retain the initial assembly torque.

Durlon® ETG's engineered design principle is focused around providing oxidation protection zones around the central oxidation inhibited flexible graphite sealing component. Standard industrial grade flexible graphite typically begins to rapidly oxidize at around 650°C (1,200°F). By adding oxidation inhibitors to the graphite, the rate and amount of oxidation can be significantly reduced, thus extending the seal life of the material. However, oxidation can still occur and at extreme temperatures, it can be fatal to the integrity of the joint.

Durlon® ETG adds an inner and outer protection boundary in the form of a mica-phyllsilicate based sealing material called Durlon® HT1000® which consists of phlogopite mica paper impregnated with an inorganic binder at less than half the binder amount found in a typical vermiculite-phyllsilicate filled product. This lower binder content allows for superior weight retention and results in ultimate extreme temperature sealing performance.

INDUSTRY APPLICATIONS:

- Mining
- Power Generation
- General/Heavy Industry
- Marine
- Refining
- Chemical Processing



The Durlon® ETG's design is the sealing industry's current best available technology for effectively sealing extreme temperature applications.

Certifications	
Fire Test	API 607, 4th edition with Exxon modifications

DRI-ETG SWG

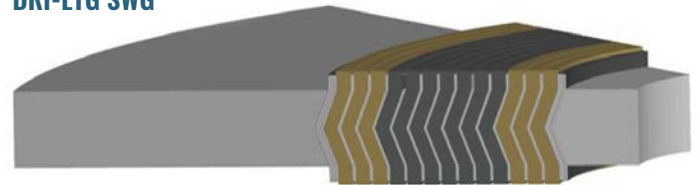

Durtec® ETG

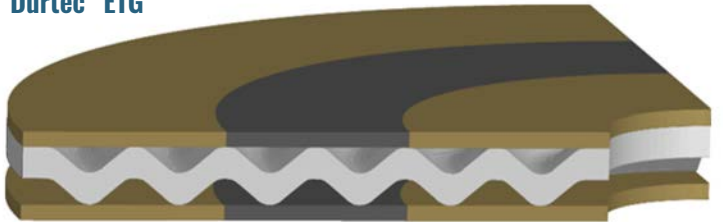

K40-ETG Kammprofile

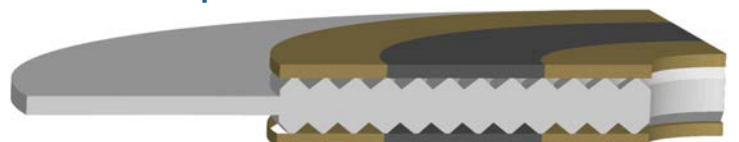

DURLON® RTJ

Ring Type Joint Gaskets
Styles: R, RX, BX



INDUSTRY APPLICATIONS:

- Mining
- Power Generation
- Oil & Gas
- Petrochemical
- General/Heavy Industry
- Marine
- OEM Services

Durlon® RTJ Characteristics

- All gaskets are completely identified with low-stress permanent markings indicating style, ring number, material and applicable standards
- All gaskets fully comply with the ASME B16.20 standard and the API spec 6A (where applicable)
- All materials are fully traceable and documentation can be supplied upon request or viewed via MetalTrace® on-line: www.trianglefluid.com/metal-trace/
- Material hardness is carefully controlled which ensures a good seal without damaging the surfaces of the flanges
- RTJ gaskets can withstand aggressive chemicals and temperatures up to 1,000°C (1,832°F) with properly selected metal
- All gaskets have a thin protective coating to eliminate oxidation effects due to atmospheric contact

Durlon® RTJ gaskets are precision machined from solid metal and designed for high pressure and high temperature services. They seal by creating very high unit load, metal-to-metal line contact, with special mating flanges. Metals are typically chosen so that the ring gasket is softer than the flange material in order to prevent damage to the flanges and thereby causing plastic flow of the gasket into the flange faces. The design of the gasket or cross-section is chosen based on the existing flange configuration and designed maximum system pressure. Gasket and flange surface finishes and dimensional accuracy along with gasket hardness must be carefully controlled in order to obtain and maintain an effective seal.

Typical octagonal RTJ flange connection

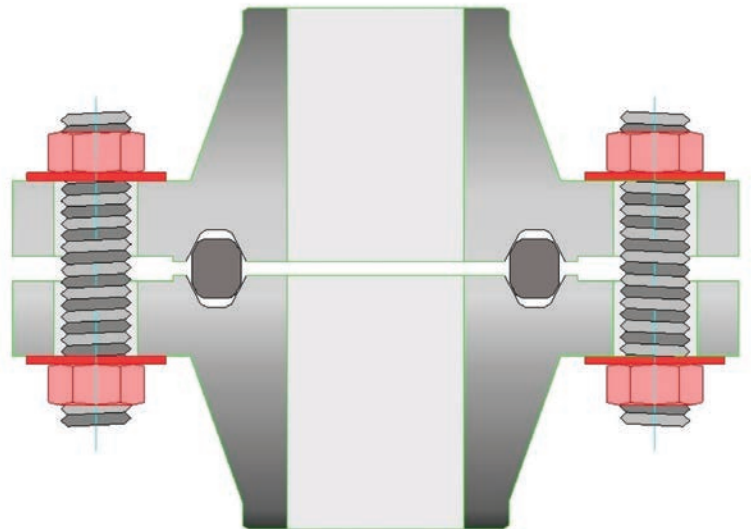

Style R

- Available in oval and octagonal cross-sections
- Durlon® Style R gaskets are interchangeable on modern octagonal flat bottom grooved flanges
- Standard sizes of Style R gaskets are manufactured in accordance with ASME B16.20 and API 6A specifications

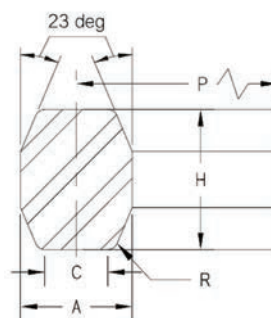

Style R - Octagonal

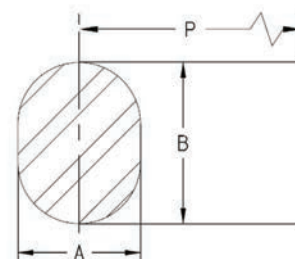

Style R - Oval



Style RX

- Durlon® Style RX ring joint has a unique self-sealing action. The outside bevels of the ring make the initial contact providing a seal against the groove's outer surfaces. As the internal pressure increases, so does the gasket loading stress against the groove thus improving the gaskets sealing characteristics
- Design features of the Style RX gasket make it more resistant to shock load, test pressure shock and drilling vibration
- Style RX ring joints are completely interchangeable with standard Style R groove designs. Care should be taken when interchanging these styles as RX gaskets are taller and will add length to the finished assembly

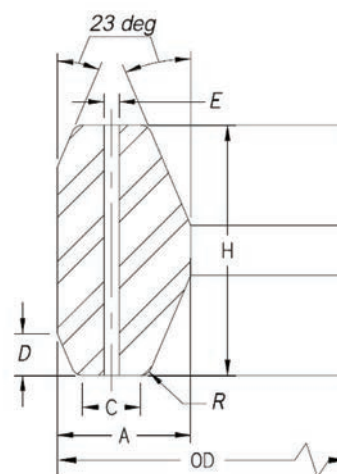

Style BX

- Durlon® Style BX gaskets have a pitch diameter slightly larger than the groove pitch diameter. This allows for initial contact to be made on the outside of the ring, pre-loading the gasket which creates a pressure energized seal
- All Durlon® Style BX gaskets incorporate a pressure passage to enable trapped pressure to balance itself in the joint
- Style BX ring joint gaskets can only be used with API BX flanges and are not interchangeable with Style RX

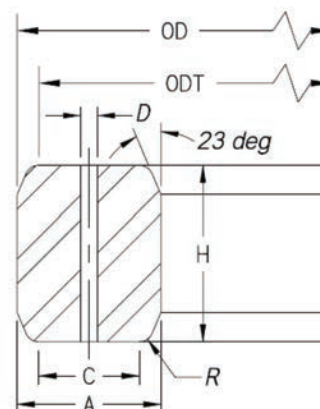

DURLON®

iGuard™

Isolation & Sealing Kits

Styles: Type F, Type E, and Type D

Type F (Raised Face Gasket)

The outside of the gasket fits inside of the flange bolt circle to ensure an exact positioning of the gasket.

Type E (Full Face Gasket)

This design facilitates proper alignment of the gasket during installation and prevents foreign material from shorting the flange isolation.

Type D (RTJ Gasket)

This design specifically fits into the ring groove of ring-type-joint flanges.

The Standard Kit

Consists of a gasket, isolating washers and isolating bolt/stud sleeves. The gasket carrier can be constructed of plain phenolic, neo-faced phenolic, epoxy glass (G-3, G-10 or G-11), epoxy glass (G-10) bonded to 316SS core, Durlon® 7910, 8400, 8500 or 9000.



Considering the environmental climate of today, it is more important than ever to prevent leakage in your piping systems. With flanges being the most common trouble area, proper sealing is key to preventing leakage. Durlon® offers quality products and materials which can help solve most flange sealing problems from eliminating leakage to preventing corrosion, and saving the integrity of the pipeline.

Our Durlon® iGuard™ flange Isolation & Sealing Kits are designed to be used on flanges and piping systems to create a dielectric break, which provides cathodic protection, assist in the prevention of corrosion and eventual break down of the metal, and isolate any current in the piping system from continuing down the line.

Gasket styles are available in Type F (Raised Face), Type E (Full Face) and Type D (RTJ) flanges from NPS 1/2" (DN15) to NPS 144" (DN 3600) or equivalent, to meet all international piping sizes. iGuard™ gaskets meet AWWA, ANSI, API, DN, JIS and all other dimensional standards.

GENERAL FEATURES

- Auto-Energizing double-ogee seal
- Low torque requirements
- Tri-directional seal movement for a tighter seal

INDUSTRY APPLICATIONS:

- Oil & Gas
- Water/Wastewater
- Food & Beverage
- Marine
- Chemical Processing
- Pulp & Paper
- Petrochemical
- Mining

PACKAGING

Each Durlon® iGuard™ Flange Isolation & Sealing Kit is packaged individually in durable corrugated boxes. Isolating sleeves and washers are packaged separately and cushioned within the box to protect them from damage during shipment. Each set is clearly tagged with flange size, pressure rating, type or isolating sleeve and whether it is a single washer or double washer set.

Carrier	Sealing Element			
	Nitrile	EPDM	Viton	PTFE
Plain Phenolic	✓	✓	✓	✓
Neo-Faced Phenolic G-3	✓	✓	✓	✓
Silicone Glass G-7	✓	✓	✓	✓
Epoxy Glass G-10	✓	✓	✓	✓
Epoxy Glass G-11	✓	✓	✓	✓
Durlon® 7910	✗	✗	✗	✗
Durlon® 8400	✗	✗	✗	✗
Durlon® 8500	✗	✗	✗	✗
Durlon® 9000	✗	✗	✗	✗

iGuard™ Kit Components



Isolating Sleeves & Washers

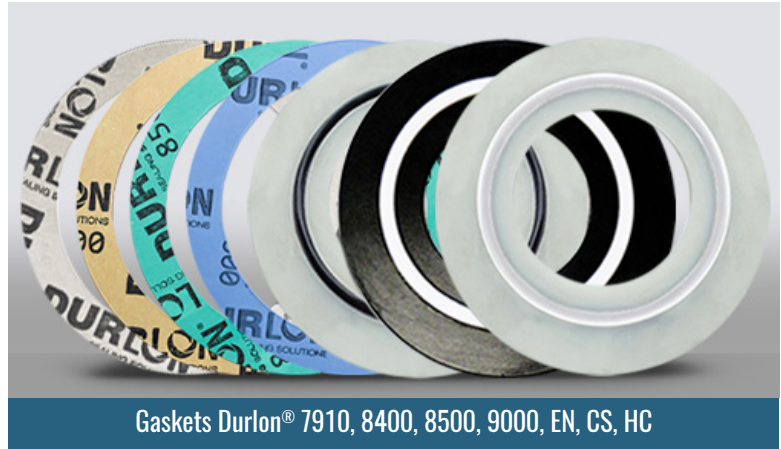

Gaskets Durlon® 7910, 8400, 8500, 9000, EN, CS, HC

iGuard™ 7910

The iGuard™ 7910 commercial grade compressed sheet gasket material is manufactured from aramid/inorganic fiber material specifically developed to meet the requirement of NSF/ANSI 61 (Certification for water treatment products that are manufactured, distributed or sold in North America) for potable water application 23°C (73°F) to commercial hot 82°C (180°F). Maximum pressure class - 300#ANSI.

iGuard™ 8400

The iGuard™ 8400 style isolation gasket is manufactured from phenolic fiber material to improve sealability in critical service chemical environments from pH 2-13 and other aggressive media to 290°C (554°F). Maximum pressure class - 300#ANSI.

iGuard™ 8500

The iGuard™ 8500 style isolation gasket is manufactured from aramid fiber material to improve sealability in steam environments to 287°C (548°F). Maximum pressure class - 300#ANSI.

iGuard™ 7910, 8400 & 8500: These kits come standard with one 3mm (1/8") thick genuine iGuard™ gasket, two isolating Nema grade G-10 washers, two SAE zinc plated steel backup washers, and one Nema grade G-10 sleeve tube for every bolt/stud. Maximum pressure class - 300#ANSI. These designs are ideal for ANSI Class 150 and 300 and come in sizes from NPS 1/2" (DN 25) to NPS 96" (DN 2400) or international equivalents in Type E (Full Face) or Type F (Raised Face) configurations.

iGuard™ 9000

The iGuard™ 9000 style isolation gasket is manufactured from 3mm (1/8") thick genuine Durlon® 9000 glass filled PTFE gasket material to improve sealability in critical service chemical environments from pH 0-14 and other aggressive media to 260°C (500°F). This design makes the iGuard™ 9000 ideal for cryogenic, petrochemical, pharmaceutical,

semiconductor manufacturing, and food and beverage manufacturing applications in ANSI Class 150 and 300 or international equivalents. Sizes available: from NPS 1/2" (DN 25) to NPS 144" (DN 3600) in Type E (Full Face) or Type F (Raised Face) configurations. This kit comes standard with one iGuard™ 9000 gasket, two isolating PTFE washers, two SAE zinc plated steel backup washers, and one PTFE sleeve tube for every bolt/stud. Maximum pressure class - 300#ANSI.

iGuard™ EN

The iGuard™ EN style isolation gasket is manufactured from Nema grade G-10/FR-4 glass epoxy material incorporating a Viton double-ogee sealing element. This kit comes standard with one iGuard™ EN gasket, two isolating Nema grade G-10 washers, two SAE Zinc plated backup washer, and one Nema grade G-10 sleeve tube for every bolt/stud. Maximum pressure class - 2,500# ANSI, 10,000# API.

iGuard™ CS

The iGuard™ CS style isolation gasket is manufactured from 3mm (1/8") thick Nema grade G-10 glass epoxy material bonded to a 316 stainless steel internal core with a spring energized PTFE sealing element to prevent cold flow in critical service applications under continuous reciprocation movement or internal pressure surges at elevated temperatures. This design makes the iGuard™ CS ideal for API Class 15,000 and ANSI Class 600, 900, and 2,500 flange applications. This kit comes standard with one iGuard™ CS gasket, two isolating Nema grade G-10 washers, two SAE zinc plated steel backup washers, and one Nema grade G-10 sleeve tube for every bolt/stud. Maximum pressure class - 2,500# ANSI, 15,000#API.

iGuard™ HC

The iGuard™ HC style isolation gasket is manufactured from special high-compression 6mm (1/4") thick Nema grade G-10 glass epoxy material incorporating a spring energized PTFE sealing element to prevent cold flow under high pressures. This kit comes standard with one iGuard™ HC gasket, two isolating Nema grade G-10 washers, two SAE zinc plated steel backup washers, and one Nema grade G-10 sleeve tube for every bolt/stud. Maximum pressure class - 2,500# ANSI, 10,000# API.

In gaskets with phenolic or glass carrier rings, the double-ogee sealing element provides a reliable concentrated unit load on the flanges, using the lowest torquing conditions possible. For other styles, a spring energized PTFE sealing element is used.

iGuard™ Material Physical Properties

ASTM Test Method	Properties	D7910	D8400	D8500	D9000	Mylar*	Plain Phenolic	Nitrile Phenolic	Virgin PTFE Teflon	Hi-Temp Phenolic G-3	Silicone Glass G-7	Epoxy Glass G-10	Epoxy Glass G-11	Critical Service CS
D149	Dielectric Strength, volts/Mil	279	371	297	406	400	500	500	285	550	350-400	550	550	488
D695	Compressive Strength psi	-	-	-	-	-	25,000	25,000	3,500	50,000	40,000	50,000	50,000+	80,000
D229	Water Absorption %	-	-	-	-	-	1.60	1.60	<.01	0.70	0.07	0.10	0.10	0.08
D257	Insulation Resistance, MegOhms	-	3.1 x 10 ⁷	4.2 x 10 ⁷	0.1	-	40,000	40,000	>10 ¹⁸	46,000	2,500	200,000	200,000	200,000
D790	Flexural Strength, psi	-	-	-	-	-	22,500	22,500	72,000	60,000	27,000	60,000	75,000+	77,000
D256	IZOD Impact Strength, Ft-Lbs/in.	-	-	-	-	-	1.2	1.2	3.5	12	8	14	12	9.1
D229	Operating Temp °F	-100 to 500	-100 to 554	-100 to 548	-350 to 500	100 to +490	-65 to +250	-65 to +175	-350 to +500	-200 to +340	-200 to +430	Cryogenic to +284	Cryogenic to +356	Cryogenic to +500
	Operating Temp °C	-73 to 260	-73 to 290	-73 to 287	-212 to 260	-75 to 255	-54 to +104	-54 to +79	-212 to +260	-129 to +171	-129 to +221	Cryogenic to +140	Cryogenic to +180	Cryogenic to +260

Mylar: The Isolation Sleeve is designed to fit over the bolt diameter & through the flange bolt holes inner diameter. The sleeve extends through both flanges & centers on the isolation washer thickness. Isolation Sleeves have a standard wall thickness of .03125" (.79mm), diameter & length of the isolation sleeve is determined by each application.

iGuard™ Installation Procedures

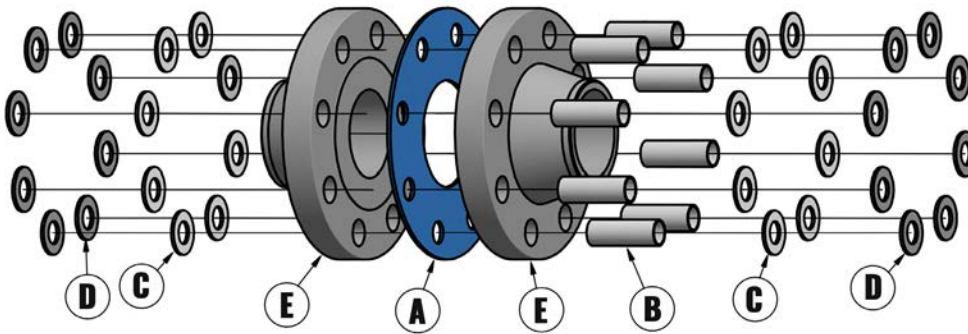

Parts List		
Description	Item	Qty
Durlon® Gasket	A	1
PTFE Sleeves	B	8
Teflon Washers	C	16
316SS Washers	D	16
Flange	E	2

BEFORE TIGHTENING

The flange faces make contact with the sealing elements which sit slightly higher than the isolating carrier ring.

AFTER TIGHTENING

The sealing element is compressed and moves bilaterally through the gasket radius thus filling the small gaps on either side of the sealing element. This radial movement provides a tighter seal with less stress on the carrier ring as compared to rectangular sealing elements used in other gasket styles in the market. The tri-directional movement of the sealing element provides better elastic recovery over time as bolt loads relax and pressure or temperature cycles occur.

NOTE: Flanges are not included in the kit. Contact our Technical Department for more information about Installation, Bolt Torquing, the Star Patterns, and Load Values: tech@durlon.com



Star Pattern Diagram

iGuard™ Recommended Application Chart

Service	Gasket	Seal	Sleeve	Washer	Temperature		Service	Gasket	Seal	Sleeve	Washer	Temperature	
					Low °C(°F)	High °C(°F)						Low °C(°F)	High °C(°F)
Acetone	Phenolic	EPDM	Mylar	Phenolic	0 (32)	27 (80)	Pentane	G10	PTFE	G10	G10	-184 (-300)	138 (280)
Air	G10	Nitrile	Mylar	Phenolic	-40 (-40)	107 (225)	Propane	G10	PTFE	G10	G10	-184 (-300)	138 (280)
Ammonia	G10	PTFE	Mylar	G10	-54 (-65)	104 (220)	Propylene	G10	Viton	G10	G10	0 (32)	27 (80)
Bleach	G10	PTFE	Mylar	G10	0 (32)	27 (100)	Sewage	G10	Viton	Mylar	G10	-29 (-20)	138 (280)
Carbon Dioxide	G10	Nitrile	Mylar	G10	0 (32)	38 (100)	Steam	-	-	-	-	-	-
Caustic Soda	ePTFE	-	ePTFE	ePTFE	-	-	Styrene	G10	PTFE	G10	G10	-184 (-300)	138 (280)
Cryogenic	G10	PTFE	G10	G10	-184 (-300)	138 (280)	Sulphur (Molten)	G10	PTFE	G10	G10	-184 (-300)	138 (280)
Ethanol	G10	EPDM	Mylar	G10	0 (32)	38 (100)	Tolulene	G10	Viton	G10	G10	0 (32)	66 (150)
Ethylene	G10	PTFE	G10	G10	0 (32)	27 (80)	Tolulene	Phenolic	Viton	Mylar	Phenolic	-40 (-40)	104 (220)
Fuel Oil	G10	Viton	Mylar	G10	-29 (-20)	138 (280)	Water, HOT	G10	EPDM	Mylar	G10	79 (175)	138 (280)
Jet Fuel	G10	Viton	Mylar	G10	-29 (-20)	107 (225)	Water, Potable	G10	EPDM	Mylar	Phenolic	0 (32)	138 (280)
Natural Gas	Phenolic	Nitrile	Mylar	Phenolic	-40 (-40)	104 (220)	Water, Sea	G10	EPDM	Mylar	Phenolic	0 (32)	138 (280)
Sour Gas	G10	Viton	Mylar	Phenolic	-29 (-20)	104 (220)	Sulfuric Acid	ePTFE	-	ePTFE	ePTFE	-	-
Gasoline	G10	PTFE	Mylar	G10	-54 (-65)	107 (225)	Sulfuric Acid <10%	G10	PTFE	G10	G10	-184 (-300)	138 (280)
Unleaded Gasoline	Phenolic	Viton	Mylar	Phenolic	-40 (-40)	104 (220)	Nitric Acid	ePTFE	-	ePTFE	ePTFE	-	-
Unleaded Gasoline	G10	Viton	Mylar	Phenolic	-29 (-20)	138 (280)	Nitric Acid <5%	G10	PTFE	G10	G10	-184 (-300)	138 (280)
Hydrogen	G10	Nitrile	Mylar	G10	0 (32)	66 (150)	Citric Acid	ePTFE	-	ePTFE	ePTFE	-	-
Black Liquor	ePTFE	-	G10	G10	-	-	Hydrochloric Acid <10%	G10	PTFE	G10	G10	-184 (-300)	138 (280)
White Liquor	ePTFE	-	G10	G10	-	-	Hydrochloric Acid	ePTFE	-	ePTFE	ePTFE	-	-
Spent Liquor	ePTFE	-	G10	G10	-	-	Acetic Acid <10%	G10	PTFE	G10	G10	-184 (-300)	138 (280)
LNG	G11	PTFE	G10	G10	-184 (-300)	38 (100)	Phosphoric Acid <25%	G10	PTFE	G10	G10	-184 (-300)	138 (280)
Mercaptan	G10	PTFE	G10	G10	-184 (-300)	138 (280)	Potassium Hydroxide	G10	PTFE	G10	G10	-184 (-300)	138 (280)
Methanol	G10	PTFE	G10	G10	-184 (-300)	138 (280)	Ammonium Hydroxide	G10	PTFE	G10	G10	-184 (-300)	138 (280)
Methyl Teriary Butyl Ether	G10	PTFE	G10	G10	-184 (-300)	138 (280)	Trichloroethylene	Phenolic	Viton	Mylar	Phenolic	-40 (-40)	104 (220)
Nitrogen	Phenolic	Nitrile	Mylar	Phenolic	-40 (-40)	104 (220)	Auto Transmission Fluid	G10	Viton	G10	G10	0 (32)	66 (150)
Crude Oil	G10	Viton	Mylar	G10	-29 (-20)	138 (280)	Auto Transmission Fluid	Phenolic	Viton	Mylar	Phenolic	-40 (-40)	104 (220)
Oxygen	ePTFE	-	G10	G10	-54 (-65)	121 (250)							

This information is a general guide for the selection of a suitable gasket material. The substances listed above are evaluated for their effect on gasket materials at ambient temperature -40°C (-40°F) to 38°C (100°F) unless stated otherwise. For unusual conditions of fluid concentration, internal pressures or temperature or applications not listed above, consult your local representative. This evaluation is based on laboratory or field tests or experience; however, no guarantee can be given as to the actual performance experienced by the end user.

Technical Information

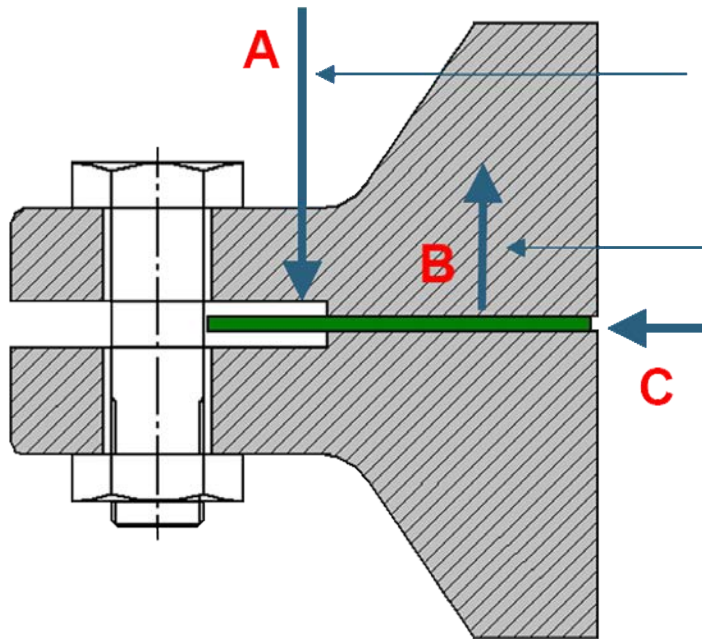

Bolt Load

Tries to keep everything together

Hydrostatic End Force

Tries to push flanges apart & stretches bolts

Blowout or Internal Pressure

Tries to force gasket out of flange

$$A - B > C$$

FORCES THAT OCCUR IN A GASKETED JOINT

The Function of a Gasket is to create and maintain a static seal between two stationary, imperfect surfaces of a mechanical system, designed to contain a wide variety of liquids or gases. The gasket must be able to maintain this seal under all the operating conditions of the system including extremes of temperature and pressure.

The performance of the gasket is affected by a number of factors. All of these factors must be taken into consideration when selecting a gasket.

The Flange Load: All gasket materials must have sufficient flange pressure to compress the gasket enough to insure that a tight, unbroken seal occurs. The flange pressure, or minimum seating stress necessary to accomplish this is known as the “Y” factor. This flange pressure must be applied uniformly across the entire seating area to achieve perfect sealing. However, in actual service, the distribution around the gasket is not uniform. The greatest force is exerted on the area directly surrounding the bolts. The lowest force occurs mid way between two bolts. This factor must be taken into account by the flange designer.

The Internal Pressure: In service, as soon as pressure is applied to the vessel, the initial gasket compression is reduced by the internal pressure acting against the gasket (blowout pressure) and the flanges (hydrostatic end force). To account for this, an additional pre-load must be placed on the gasket material. A “m” or maintenance factor has been established by ASME to account for this pre-load. The “m” factor defines how many times the residual load (original load minus the internal pressure) must exceed the internal pressure. In this

calculation, the normal pressure and the test pressure should be taken into account.

Temperature: The effects of both ambient and process temperature on the gasket material, the flanges and the bolts must be taken into account. These effects include bolt elongation, creep relaxation of the gasket material or thermal degradation. This can result in a reduction of the flange load. The higher the operating temperature, the more care needs to be taken with the gasket material selection. As the system is pressurized and heated, the joint deforms. Different coefficients of expansion between the bolts, the flanges and the pipe can result in forces which can affect the gasket. The relative stiffness of the bolted joint determines whether there is a net gain or loss in the bolt load. Generally, flexible joints lose bolt load.

Fluid: The media being sealed, usually a liquid or a gas, with a gas being harder to seal than a liquid. The effect of temperature on many fluids causes them to become more aggressive. Therefore, a fluid that can be sealed at ambient temperature may adversely affect the gasket at a higher temperature.

Both the “m” and “Y” factors will vary with the type of gasket and the thickness of the gasket. Always consult with the manufacturer to determine the “m” and “Y” factors for the gasket material you are using.

In any application, failure to meet the “m” or “Y” factor will result in an imperfect seal and will require a change in the gasket design. This change can sometimes be made by simply decreasing the gasket

surface area or by using a thicker gasket. However, since thinner gaskets are generally more effective, changing to a thicker gasket may not be the most satisfactory long-term solution. In some cases, a revision to the flange design may be required.

Newer gasket design factors being developed by ASME are for bolted joint designs where it is important that a desired level of tightness be achieved. “m” and “Y” factors do not take fugitive emissions into account, whereas the new assumption is that all bolted joints leak to some extent. This “systems approach” focuses on all the components of the bolted joint not just the gasket. A tightness parameter (T_p), is a defined measure of tightness of a joint. A higher value for T_p , represents a lower rate of leakage. See additional discussion under “Other Considerations”, in the section on “Gasket Selection” (pg. 52).

FLANGE FINISHES

It is common for pipe flange finishes to vary depending on the age and condition of the piping and the gasket material considered in the initial design. Concentric-serrated finishes are most commonly used in industry, with spiral-serrated (phonographic) finishes being less prevalent. The recommended flange finish depends on the type of gasket being used. The table (below right) illustrates the Durlon® recommended flange surface finishes by gasket type.

The finish or the condition of the gasket seating surface has a definite effect on the ability of the gasket to create a seal. Soft gaskets made from sheet material are designed to have a seating stress that allows the gasket material to “flow” into the serrations and irregularities of the flange face. The serration’s “bite” aids the gasket in resisting the effects of internal pressure, creep, and cold flow.

We recommend that metal flange faces be machined with a concentric-serrated finish of 125-500 AARH, with 250 AARH being the optimum for non-metallic gaskets. Phonographic serrations can also be used with our materials. It should be recognized, however, that their continuous leak path makes them more difficult to seal.

“Smooth” finishes are usually found on machinery or flanged joints, rather than pipe flanges. When working with a smooth finish, it is important to consider using a thinner gasket to lessen the effects of creep and cold flow. It should be noted, however, that both a thinner gasket and the smooth finish, in and of themselves, require a higher compressive force (i.e. bolt torque) to achieve the seal.

Therefore, due to the flange design, one may have to resort to a thicker gasket, which requires a lower compressive force to seat the gasket. Another way to seat the gasket, when there is insufficient compressive force available, is to reduce the area of the gasket.

FLANGE TYPES

The majority of flange materials used in industry are metallic and come in a variety of metallurgies, depending on the nature of the application’s pressure, temperature, and media requirements. Some

applications require non-metallic flange materials, such as reinforced plastic, glass-lined steel, and glass. However, these materials are less robust and “softer” gasketing materials must be used.

RAISED FACE to FULL FACE: We do not recommend mating a Full Face flange to a Raised Face flange, especially when the Full Face flange is cast or ductile iron. Due to the potential for warping the flange, or in the worst case cracking it, the utmost care should be taken.





Even if a spacer that fits on the Raised Face flange outside the Raised Face area is used, damage to the flanges can still occur and great care should be taken.

FULL FACE FLANGES: In a bolted joint using ANSI Full Face (or flat face) flanges it must be remembered that the same bolts used in the corresponding Raised Face joint are now being asked to seal 3 to 4 times the gasket area with Full Face flanges. It is almost impossible to create an effective seal and high strength bolts should be considered.

ANSI Class 150 Full Face bolted joints are poor design and should only be used for non-critical fluids.

ANTI-SEIZE COMPOUNDS

We do not recommend the use of metal-based anti-seize compounds due to the following issues that must be considered: under heat and pressure, the metals in the compound can adhere to the flange surface, causing distortion of the flange and/or fill in the serrations. After a period of time, when this condition has been allowed to progress, no amount of additional torque will allow the gasket to seal.

Gasket Description	Gasket Cross Section	Flange Surface Finish Micro-inch Ra.	Flange Surface Finish Micrometer Ra.
Metallic Serrated Gaskets		63 Max.	1.6 Max.
Spiral Wound Gaskets		125 - 250	3.2 - 6.3
Kammprofile Gaskets		125 - 250	3.2 - 6.3
CFG / Durtec		125 - 250	3.2 - 6.3

Applying anti-seize to the gasket lubricates the sealing surface. This isn't a problem until gasket compression is lost for some reason. The lubricated gasket can either be extruded, attacked chemically, or forced out of the flange by the internal pressure. Here the friction created by the flange serrations play a role.

For these reasons the use of anti-seize is not recommended. The important thing is keeping the flange serrations intact, by making sure they are thoroughly cleaned each time a gasket is changed to maintain it's integrity, to get good compression on the gasket, and a minimum bolt stress of at least 40% of bolt yield.

THE SEAL

As stated previously, the purpose of a gasket is to create a static seal between two stationary flanges. The seal itself is created by achieving the proper compression on the gasket causing it to flow into the imperfections on the surface of the flange. This results in a tight, unbroken barrier, impervious to the fluid being contained.

In many instances, a good seal is obtained through the limited "swell" caused by the reaction of the inside edge of the gasket material with the fluid being contained.

A certain amount of swell is desirable, as long as it reaches an equilibrium and does not reach a condition of degradation where the gasket begins to breakdown. In many instances, the fluid being contained may "cauterize" the inside edge of the gasket and "seal off" the gasket from further fluid penetration.

BOLTING

Bolted flange connections are only as good as the fastener system being used and unfortunately the fastener system is often overlooked within the design. The majority of fastener systems being used in the industrial world are threaded. The fastener system consists of at least the bolt/stud and the nut, but it is recommended to also include washers.

The application and distribution of torque can be improved through the use of washers under the head of the bolt and between the flange and nut. Washers effectively reduce the friction between the turning surfaces of the nut and bolt head to the flange, thus translating into a more accurate load being applied to the gasket. For standard applications it is recommended to use through-hardened washers, in order to prevent washer galling.

Bolting should be of sufficient strength to achieve proper compression of the gasket, to not only seal the joint, but to also maintain the seal without exceeding the yield strength of the bolts being used. The torque values in our torque tables (pg. 63-66) are based on using ASTM A193 Grade B7 studs and 2H heavy hex nuts lubricated with never seize.

Since sheet gasket materials have micro pores, they must be sufficiently compressed to reduce porosity. Without adequate compression the system pressure can force the contained fluid into the gasket and degrade it.

Therefore, when installing the gasket it is important that good technique be followed including cleaning the flanges, inspecting the flange face and bolts, and bringing the flanges together parallel and in stages. Many field problems arise from improperly installed gaskets. Refer to the "Bolt Tightening Worksheet" (pg. 59) for more information on installation procedures.

MINIMIZING TORQUE LOSS

Proper gasket selection and installation should be based on minimizing torque loss. Torque loss can be caused by the tendency of the gasket to relax or remold after it has been compressed and/or by elongation of the bolts. This loss can be minimized several ways:

Use of a thinner gasket: the surface of the gasket is actually the sealing surface. The internal portion of the gasket is used primarily to insure that the imperfections in the sealing surface are filled. Since it is this internal portion that is primarily affected by creep relaxation, the thinner the gasket, the more effective the seal. However, if the surface to be sealed is pitted or marred or is somewhat distorted, it may not be feasible to switch to a thinner gasket.

Use of a denser gasket: in general, the denser the gasket material, the less creep relaxation will occur. With materials of similar composition, greater density will require greater seating stresses to seal. Therefore, some lighter flanges may not be strong enough to use with a denser material.

Use of conical washer: the elastic effect of a conical washer helps to compensate for some of the loss in gasket resilience. The washer also lengthens the bolt to a slight degree, lessening the effect of bolt elongation.

Greater bolt load: the use of stronger bolts or more bolts can also help in the reduction of torque loss. Care should be taken to insure that the maximum loads on the bolts are not exceeded.

GASKET SELECTION

The importance to the environment of selecting the right gasket for today's services cannot be overstated. With the emphasis on fugitive emissions gaining more and more prominence, selecting the proper gasket involves many considerations.

- Human safety
- Process safety
- Environmental concerns
- Life of service in the flange
- Maintenance costs
- Inventory costs

Other considerations when selecting a gasket are:

- Chemical compatibility with the process fluid
- The pressure-temperature (PxT Factor) relationship of the gasket to the service conditions
- Physical and mechanical properties of the gasket material
- Other considerations such as fire safety, and gasket design factors

TORQUE

Proper gasket selection and installation should be based on minimizing torque loss. Torque loss can be caused by the tendency of the gasket to relax or remold after it has been compressed and/or by elongation of the bolts. This loss can be minimized several ways:

1. Use of a thinner gasket: The surface of the gasket is actually the sealing surface. The internal portion of the gasket is used primarily to ensure that the imperfections in the sealing surface are filled. Since it is this internal portion that is primarily affected by creep relaxation, the thinner the gasket, the more effective the seal. However, if the surface to be sealed is pitted, marred or somewhat distorted, it may not be feasible to switch to a thinner gasket.

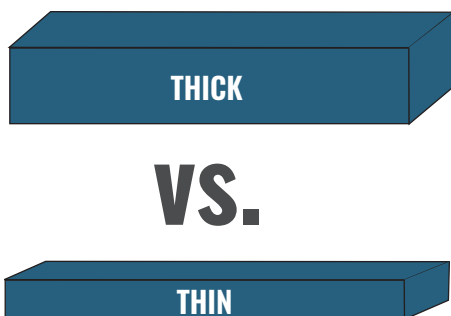

2. Use of a denser gasket: In general, the denser the gasket material, the less creep relaxation will occur. With materials of similar composition, greater density will require greater seating stresses to seal. Therefore, some lighter flanges may not be strong enough to use with a denser material.



(LOW DENSITY)

VS.

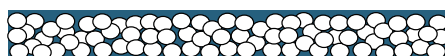

(HIGH DENSITY)

3. Use of a conical washer: The elastic effect of a conical washer helps to compensate for some of the loss in gasket resilience. The washer also lengthens the bolt to a slight degree, lessening the effect of bolt elongation.

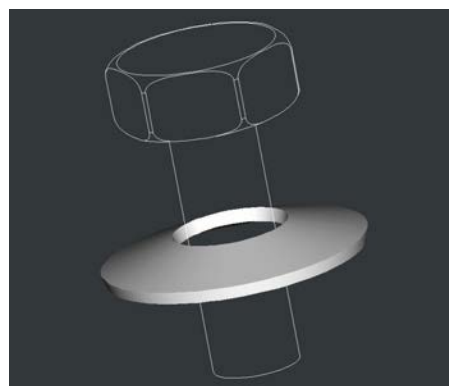

4. Greater bolt load: The use of stronger bolts or more bolts can also help in the reduction of torque loss. Care should be taken to insure that the maximum loads on the bolts are not exceeded.

WASHERS AND PLACEMENT



TYPICAL ASTM BOLTS/NUT MATERIALS USED IN BOLTED FLANGE CONNECTIONS

Bolt Grade Designation	Nut Grade Designation	Bolt Yield Strength ⁽¹⁾	Applications
A 193 B7/L7	A 194 2H	517 to 724 MPa (75 to 105 ksi)	General Use
A 193 B16	A 194 7	586 to 724 MPa (85 to 105 ksi)	High Temperatures
A 193 B8 cl. 2 ⁽²⁾	A 194 8	345 to 689 MPa (50 to 100 ksi)	Higher Temperatures & Stainless Steel Flanges
A 193 B8M cl. 2 ⁽²⁾	A 194 8M	345 to 655 MPa (50 to 95 ksi)	Higher Temperatures & Stainless Steel Flanges
A 320 L7	A 194 4 or 7	517 to 724 MPa (75 to 105 ksi)	Cryogenic & Low Temperature

1 – Yield strength at room temperature varies with bolt/stud nominal diameter.

2 – Bolt/stud A 193 B8 cl. 1 and A 193 B8M cl.1 have yield strength less than the cl. 2 listed in the table. The difference frequently is not recognized and has been the cause of failures.

CHEMICAL COMPATIBILITY

Chemical resistance of the gasket material is important because without it, the other properties of the gasket are irrelevant. It is also important to keep in mind the effect temperature has on chemical resistance.

The chemical resistance charts (pg. 67-74) can be a helpful guide. This information is available but it must be remembered that most chemicals become more reactive at higher temperatures. This must always be considered when selecting the gasket.

In some instances it is only prudent to consider field testing in a controlled application and we encourage this.

PRESSURE-TEMPERATURE (PXT FACTOR)

In all piping systems the flanges, valves, and the piping itself have a pressure – temperature relationship. This Pxt factor is the result of multiplying the operating pressure times the operating temperature to arrive at a numerical value. This value is not constant and is different at each temperature and pressure combination.

In the table below, the Pxt factors for carbon steel piping per ANSI B16.34 and saturated steam are shown. The fact that Pxt values exist for piping should indicate that such values also exist for gasketing, and just like piping, those values change with differences in the pressure and temperature.

PRESSURE-TEMPERATURE RELATIONSHIPS						
Temp °F	(Carbon Steel) Class 150		(Carbon Steel) Class 300		Saturated Steam	
	psi	(P x T)	psi	(P x T)	psi	(P x T)
100	285	(28,500)	740	(74,000)	1	(100)
200	260	(52,000)	675	(135,000)	12	(2,400)
300	230	(69,000)	655	(196,500)	68	(20,400)
400	200	(80,000)	635	(254,000)	250	(100,000)
500	170	(85,000)	600	(300,000)	680	(340,000)
600	140	(84,000)	550	(330,000)	1550	(930,000)
700	110	(77,000)	530	(374,500)	3100	(2,170,000)

The following chart graphically represents the information presented above.
 Pressure - Temperature Ratings for ANSI Class 150, 300 and 600 WCB Piping Components (ASME/ANSI B16.34-1988)

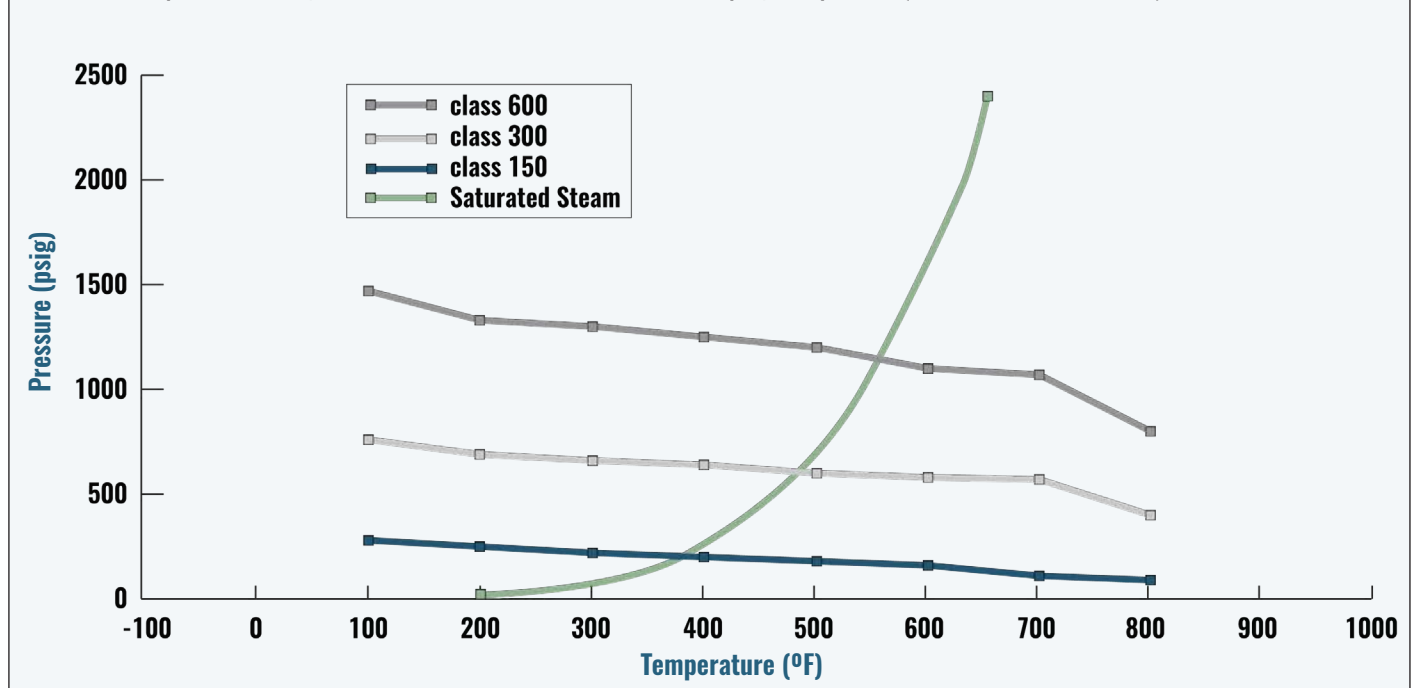

Now we can look at how sheet gaskets fit. As stated above just like piping, the P×T relationship for gaskets changes

with each pressure – temperature combination and therefore is not a constant.

The following chart shows compressed non-asbestos and compressed asbestos gasketing vs. three different pressure classes and saturated steam for reference. All sheet non-asbestos gasketing should be limited to Class 300 and below.

Pressure - Temperature Ratings for ANSI Class 150, 300 and 600 WCB Piping Components (ASME/ANSI B16.34-1988) vs. Sheet Gasketing

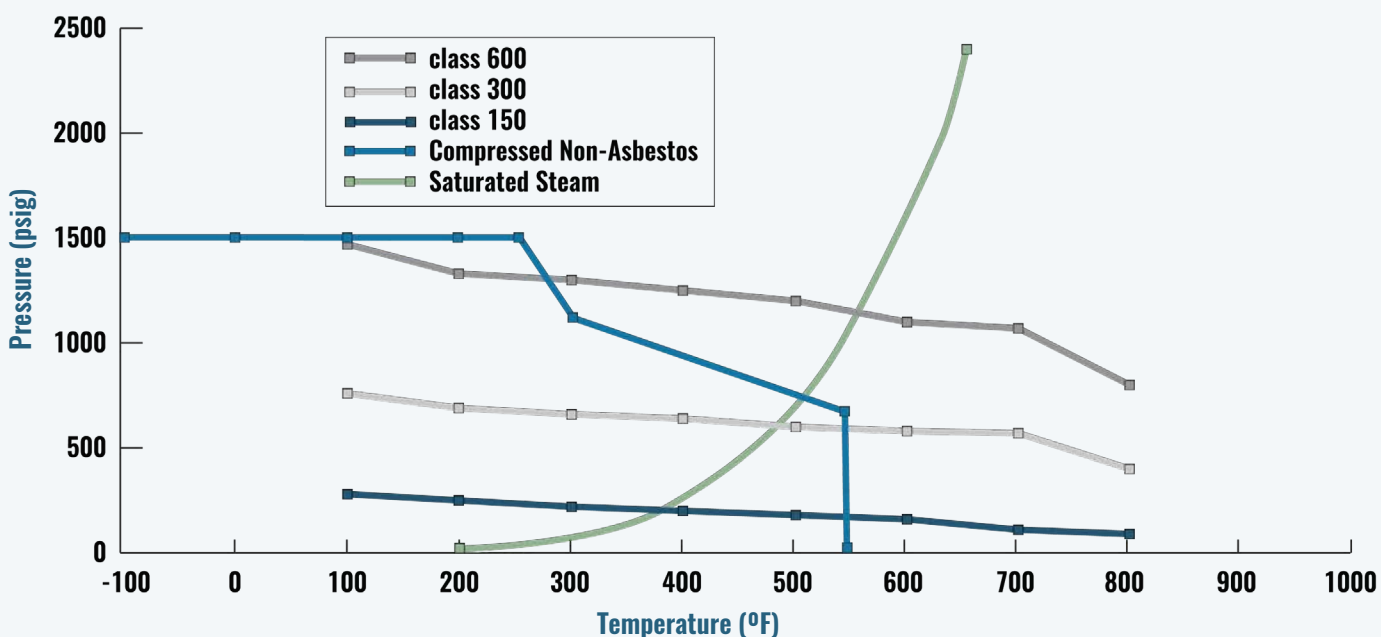

PHYSICAL AND MECHANICAL PROPERTIES

ASTM F104, the Standard Classification System for Non-metallic Gasket Materials includes a line call-out encompassing ASTM test methods for evaluating the physical and mechanical properties of non-metallic gasket materials.

Some of these ASTM tests are:

F 36 – Compressibility and Recovery

F 2378 – Sealability

F 38 – Creep relaxation

F 146 – Fluid Resistance

F1574 – Compressive Strength

In addition to ASTM tests, we also do testing to BSI (British Standards), DIN (German Institute for Standardization) and FSA (Fluid Sealing Association) standards. These tests include:

ASTM – F2837 – Hot Compression

DIN – 3535 – Gas Permeability

FSA – NMG-204 – High Pressure Saturated Steam Test

OTHER CONSIDERATIONS

Fire safe capability. There is no standard for “fire safe” gasket materials. Durlon® 8500 passed the API 6FB, Durlon® 8900 passed the API 607 and Durlon® 9000 passed the API 6FA fire tests - all done by an independent lab.

API Spec 6FB, Fire Test for End Connections, and API Bulletins, 6F1 and 6F2, do discuss fire testing but for metal gaskets and API rings, not soft gasket material.

Gasket design factors. The m and Y values established by ASME and the newer design factors being developed by the PVRC for fugitive emissions, are additional considerations. The m and Y values do not take fugitive emissions into account whereas the newer tightness parameters (Tp) do.

These gasket factors recognize that all joints leak to some extent. Therefore, an acceptable level of leakage is defined. A leak rate of 1/2480 lb/hr per inch of OD (0.002 mg/sec. mm) has been defined as a “standard” acceptable leak rate and is known as T2.

Tp classes and their associated leak rates are as follows:

T1 – Economy – 1/25 lb/hr per inch of OD (0.2 mg/sec. mm)

T2 – Standard – 1/2,480 lb/hr per inch of OD (0.002 mg/sec. mm)

T3 – Tight – 1/248,000 lb/hr per inch of OD (0.00002 mg/sec. mm)

Torque values for Durlon® products are calculated using a tightness parameter of T3.

Gasket Installation

JOINT DISASSEMBLY WARNING

Prior to any joint disassembly, it is essential that plant procedures (lock-out and tag-out procedures) have been followed to depressurize and de-energize the system, including the removal of liquid head from the system, to ensure that the BFJA (Bolt Flange Joint Assembly) may be safely opened.

After reaffirming that all pressure on the joint has been released and the joint has been separated, proceed with bolt loosening and nut removal. Good general practice is to loosen the side of the joint away from yourself first to ensure in case of an accidental release that it is directed away from yourself. Disassembly of a BFJA should be conducted in a similar fashion as the initial assembly. Bolts should be loosened in increments and also in a crisscrossed pattern to ensure an even unload. The first loosening should be done at approximately 50% of the original recommended torque. Once joint separation is achieved, proceed with the balance of the bolt loosening and nut removal. An aid such as a hydraulic or manual flange spreader may be used if necessary to separate the joint.

Torque loss is inherent in any bolted joint. The combined effects of bolt relaxation, gasket creep, vibration in the system, thermal expansion, and elastic interaction during bolt tightening, contribute to torque loss. When torque loss reaches an extreme, the internal pressure exceeds the compressive force holding the gasket in place and a leak or blowout occurs.

A key to reducing these effects is proper gasket installation. Reduced maintenance costs and increased safety can be obtained by bringing the flanges together slowly and parallel when installing a new gasket, taking a minimum of four bolt tightening passes, and following the correct bolt tightening sequence/pattern.

Even when installation is ideal, the bolt stress is uniformly applied to each bolt, and the gasket is properly compressed, problems can still arise.

Inherently with time, loosening will occur due to gasket factors already mentioned. If other factors such as cycling, thermal upsets or vibration are present, periodic re-torquing might be necessary.

CAUSES OF GASKET FAILURE

- Uneven loading of flanges holding gasket in place
- Gasket load too low
- Bolt strength too low
- Torque loss
- Bolt relaxation/strength (approximately 10% torque lost in first 24 hours)
- Gasket creep
- Vibration in the system
- Thermal cycling



- Water hammer
- Elastic interaction during bolt tightening
- Improper gasket installation practice

REDUCING GASKET FAILURES

- Use proper gasket installation practices
- Lubricate bolts, washers and nut facings
- Bring the flanges together slowly and parallel (multiple passes with increasing torque, each pass following proper tightening sequence).
- Use a 1/16" thick gasket up to 8" flanges and 1/8" for 10" and above. (1/16" has less gasket creep)
- Be sure there is adequate gasket stress
- Periodic re-torquing
- Use the correct tightening pattern/method for the job. Order of efficiency (least to greatest):
 - 1) Torque wrench
 - 2) Hydraulic torque wrench
 - 3) Hydraulic stud tension
- Use the installation procedures that follow on the bolt tightening worksheet (pg. 59)
- Refer to torque information from your gasket manufacturer torque data tables (pg. 63-66)

IMPROPER GASKET INSTALLATION

This is an over simplification of over-tightening that can occur on some Class 150 flanges because they are lightweight. In the industry we call this flange rotation since the outside edges of the flange “rotate” toward each other as illustrated here.

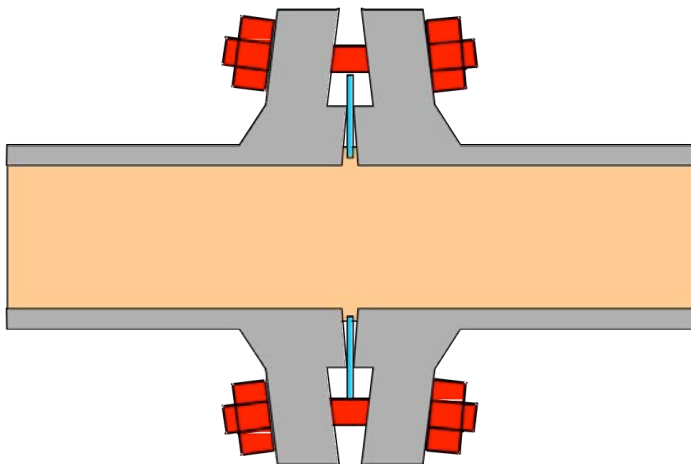

EFFECTS OF OVER-TIGHTENING

- Reduces The Gasket Contact Area
- Crushes The Gasket toward OD
- Allows fluid to penetrate gasket ID leading to deterioration of gasket
- Damages The Flanges
- Result: Leakage

This happens in Class 150 flanges because they are thinner and not thick enough to resist bending when a high stress is applied. Besides damaging the flanges, this over-tightening can damage the gasket and lead to leakage.

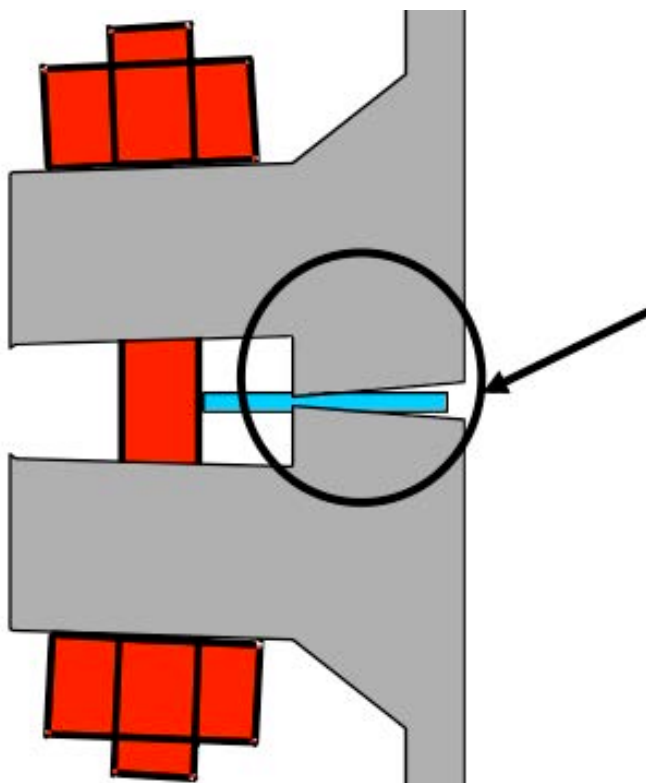

The above gasket was received from a Vinyl Chloride Manufacturer. It's a 10" Class 150 ring gasket that leaked. It was cut approximately 270 degrees around by the outside edges of the mating Raised Faces on the flanges.

This is an example of over-tightening. A high stress was applied, most likely with an air impact, or a very long cheater bar.

Below and at a closer view, we can notice the focal point where stress was applied. As you can see the jagged edge on the gasket ID goes in opposite directions from the focal point.

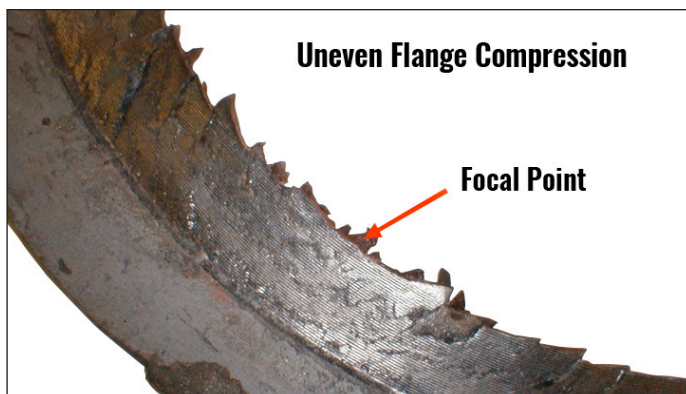

EFFECTS OF UNDER TIGHTENING

- Allows fluid to penetrate gasket ID leading to deterioration of gasket
- Under-loading can lead to blowout or leakage
- Unloading caused by temperature or pressure cycling can have the same effect

The opposite of overloading is under-tightening. This is where insufficient load is applied, which allows fluid to penetrate and degrade the gasket. Remember all gaskets are porous and they require a sufficient load to seal.

Proper Installation Instructions

CLEAN & EXAMINE

- Make sure system is at ambient
- Remove all foreign material and debris
- Examine condition of fasteners
- Examine flange surfaces
- Replace components found to be defective

Examine flange surfaces for warping, radial scores, heavy tool marks, or anything prohibiting proper gasket seating

ALIGN FLANGES

- Align flange faces and bolt holes
- Do not use excessive force
- Use proper alignment tooling
- Report any major misalignment

INSTALL GASKET

- Assure gasket is specified size and material
- Examine gasket for defects (always use a new gasket)
- Carefully insert and center gasket between flanges - never use more than one gasket in a flanged joint at a time
- Do not use release agents
- Bring flanges together ensuring the gasket is not pinched or damaged

LUBRICATE LOAD-BEARING SURFACES

- Use approved or specified lubricants only
- Liberally apply lubricant uniformly to all thread, nut, and washer load-bearing surfaces
- Ensure lubricant doesn't contaminate the flange or gasket face

INSTALL AND TIGHTEN BOLTS

- Always use a calibrated, controlled tensioning device when possible
- Consult with your gasket supplier for the gasket manufacturer's torque specifications
- Always torque nuts in a cross bolt tightening pattern or other alternatives (PCC-1 Appendix F)

STEP 1

Tighten all nuts initially by hand or small hand wrench for large bolts

STEP 2

Torque each nut to approximately 30% of the final desired torque

STEP 3

Torque each nut to approximately 60% of the final desired torque

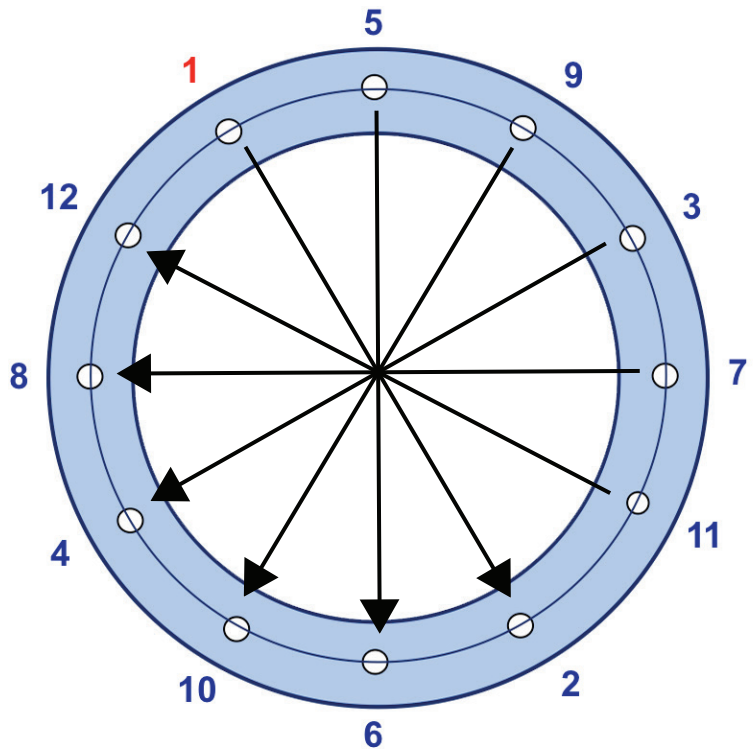

STEP 4

Torque each nut to final torque using the same cross bolting pattern (as shown above)

STEP 5

Apply at least one final torque to all nuts in a rotational direction until torque is uniform

RE-TIGHTENING

- Re-tighten nuts at ambient temperature after 12-24 hours
- Always re-tighten when system is exposed to aggressive thermal cycling
- Consult with the gasket manufacturer for specific recommendations on re-tightening under "hot" conditions

BENEFITS OF PROPER GASKET INSTALLATION

- Increased Gasket Contact Area
- Uniform Gasket Compression
- Increased Gasket Life
- Reduced Maintenance Costs
- Reduced Leakage

Note: If unsure about flange finish, defects, alignment or alternative tightening procedure, please refer to ASME PCC-1 Guideline for pressure boundary bolted flange joint assembly.

Bolt Tightening Worksheet

DURLON® GASKETING - BOLT TIGHTENING WORK SHEET

Location/Identification: _____ Nominal Bolt Size: _____

Gasket Contact Surface Finish on Flange: _____ Lubricant Used: _____

(Initial each step)

- ___ 1. Be sure system is at ambient temperature and depressurized. Follow local safety rules.
- ___ 2. Visually examine and clean flanges, bolts, nuts, and washers. Replace components if necessary.
- ___ 3. **Lubricate bolts, nuts, and nut bearing surfaces.** Use of hardened steel washers are recommended.
- ___ 4. Install new gasket. DO NOT REUSE OLD GASKET OR USE MULTIPLE GASKETS.
- ___ 5. Number bolts in cross-pattern sequence according to the appropriate sketch below.
- ___ 6. **IMPORTANT! HAND TIGHTEN NUTS, then use a hand wrench, SNUG BOLTS 1/8 to 1/4 turn, following the appropriate cross-pattern tightening sequence for the number of bolts below.**
- ___ 7. Starting at the #1 bolt, use the appropriate cross-pattern tightening sequence in the sketch below for Rounds 1, 2, and 3 (each sequence constitutes a "Round").

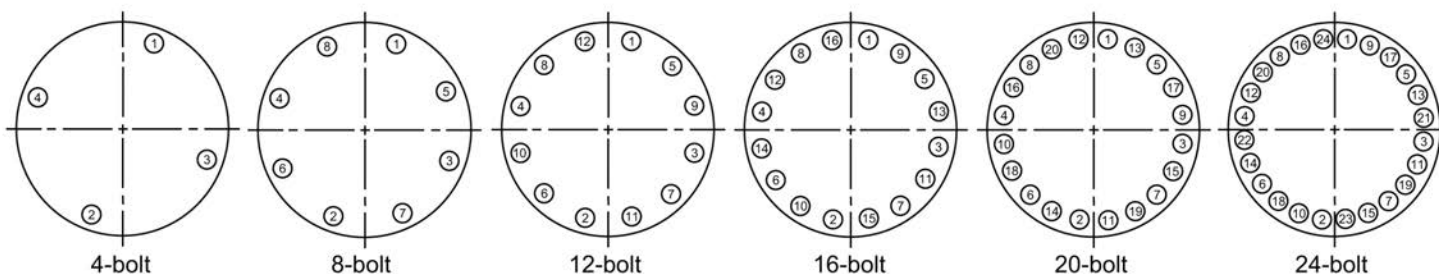

___ **Final Torque:** _____ ft-lbs

LUBRICATE, HAND TIGHTEN, PRE-TIGHTEN BOLTS

- ___ **Round 1** - Tighten to _____ ft-lbs - **1st torque** value in torque chart (30% of final torque)
- ___ **Round 2** - Tighten to _____ ft-lbs - **2nd torque** value in torque chart (60% of final torque)
- ___ **Round 3** - Tighten to _____ ft-lbs - **Final torque** value in torque chart (100% of final torque)

Check gap at 90° intervals around the flange between each of these rounds. Larger flanges may require checking the gap in smaller intervals. If the gap is not reasonably uniform, make the appropriate adjustments by selective bolt tightening before proceeding.

- ___ **Rotational Round** - 100% of Final Torque (same as Round 3). Use **ROTATIONAL**, clockwise tightening sequence, starting with Bolt No. 1, for at least two complete rounds and continue until no further nut rotation occurs at 100% of the Final Torque value for any nut.

- ___ **Retorque** - Short-term bolt preload loss can occur between four to twenty-four hours after initial tightening due to bolt relaxation and/or gasket creep. Repeating the Rotational Round recovers this loss. This is especially important for PTFE gaskets.

Joint Assembler: _____ Date: _____

For torque questions, or tightening patterns for large diameter flanges, contact TFC: tech@trianglefluid.com or call (613) 968-1100, or GRI: tech@durlon.com or call (866) 707-7300

**** This page can be copied for use in the field ****

GASKET INSTALLATION TRAINING

**HAVE RIG...
WILL TRAVEL**

IDEAL FOR:

- ✓ Pipe-fitters
- ✓ Maintenance Personnel
- ✓ Engineers
- ✓ Gasket Distributors & Fabricators



DURLON
SEALING SOLUTIONS

**FREE
TRAINING**

**Our Gasket
Installation
Training Rig
is completely
portable.**

TO REQUEST TRAINING DATES:
email info@durlon.com or call
(866) 537-1133 in Canada or
(866) 707-7300 in the USA

**FROM BEGINNER TO ADVANCED
TRAINING OPTIONS**
LET US CUSTOM FIT YOUR NEEDS

CALL NOW!

TRAINING BENEFITS

- ✓ Learn about bolted flange connections
- ✓ Increase gasket life
- ✓ Reduce maintenance costs
- ✓ Become proactive to fugitive emissions & the environment
- ✓ Increase plant pipeline safety & reliability

**WE CAN
CONVENIENTLY
SET UP AT YOUR
LOCATION!**

*Does not include Rig transportation and other administration costs - based on location and meeting minimum enrollment criteria.

Gasket Factors



Gasket factors are very important to understand but unfortunately can be difficult to understand or are easily misinterpreted. This section contains some of the more popular versions of Gasket Factors used in determining the recommended torque for gasket installation.

EN 13555

EN 13555 is a working standard, much like ASME PVRC gasket factors, in the EU. It provides the testing procedures to allow persons to derive the gasket parameters: Q_{smax} , $Q_{(minL)}$, $Q_{smin(L)}$, P_{QR} , and E_G so they can be used in design equations found in EN 1591-1 (Flanges and Their Joints - Design Rules for Gasketed Circular Flange Connections - Part 1: Calculation). For a further definition of the gasket parameters see chart (to right).

When the final torque values are calculated using the previous gasket parameters, leakage can be classified into three tightness classes:

Gasket Parameters	
Q_{smax}	Maximum seating stress required on the gasket at a given temperature without crushing the material.
$Q_{(minL)}$	Minimum seating stress that is required in assembly at ambient temperature to seat gasket into the flange serrations and seal internal leakage, based on tightness class, L, and specified test pressure.
$Q_{smin(L)}$	Minimum gasket seating stress required in service conditions after unloading gasket (at service temperature), so that the specified tightness class L, is maintained based on internal test pressure.
P_{QR}	This factor allows for the gasket's effect on the load applied and the relaxation of the gasket from start (final bolt-up) and after the extended life term of the material's intended service temperature.
E_G	This is the unloading moduli, which is derived from the recovery of the gasket thickness between the initial compression seating stress and unloading the gasket to 1/3 of its initial seating stress.

Tightness Class	Specific Leak Rates (mg/s-m)
$L_{1.0}$	1.0
$L_{0.1}$	0.1
$L_{0.01}$	0.01

m & Y

m and Y values are for flange design only and are not meant to be used as gasket seating stress values in actual service. "m" is known as the maintenance factor or the multiplier. The "Y" factor is the minimum stress required (psi) over the sealing area of the gasket to provide a seal at an internal pressure of 2 psig. "Y" is not considered to be the minimum seating stress for the gasket in service. These values are used in formulas in the ASME Boiler and Pressure Vessel Code, Division 1, Section VIII, Appendix 2, to give a WM1 (minimum required bolt load for operating conditions, psi) or WM2 (minimum required bolt load for gasket seating, psi) value, based on either gasket seating or the internal pressure. The flange is designed based on the greater of these two values (WM1 or WM2). This will ensure that the flange is robust enough to maintain adequate gasket seating stress, which can decline due to flange rotation with weaker flanges when bolted up and internal pressure is introduced. These values do not take fugitive emissions into account and therefore, based on leakage, newer gasket constants G_b , a, and G_s are being developed, based on leakage to take this into account.

Alternative ASME PVRC Gasket Factors: G_b , a and G_s

New gasket factors to replace the ASME Code m and Y are currently being developed by the Pressure Vessel Research Council (PVRC) and ASME. The current m and Y are difficult to replicate for non-asbestos gaskets and do not take joint leakage into account. The new

Tightness Type	Economy		Standard		High		Exceptional	
Tightness Class	T1	T1.5	T2	T2.5	T3	T3.5	T4	T4.5
Leak Rate (mg/s/mm)	2.0E-01	2.0E-02	2.0E-03	2.0E-04	2.0E-05	2.0E-06	2.0E-07	2.0E-08
Compressed Non-Asbestos & PTFE Materials	2.5:20 (2,900)		14.2:20 (2,900)	32.3:60 (8,700)	14.3:100 (14,500)		11.5:160 (23,200)	98.9:160 (23,200)
			7.9:40 (5,800)	7.9:80 (11,600)				
			2.7:60 (8,700)	2.4:100 (14,500)	1.7:160 (23,200)	3.4:160 (23,200)		
Graphite Filled Spiral Wound Gasket	8:20 (2,900)				7:80 (11,600)		8:120 (17,400)	-
	4:40 (5,800)				4:160 (23,200)			-
	2.5:60 (8,700)							-

Recommended Value	Possible Value	Not Recommended Value
-------------------	----------------	-----------------------

approach to bolted joint design makes the tightness of the joint a design parameter. In a manner similar to that of the traditional ASME Code method, the design bolt load for a joint is calculated for operating and seating requirements from the new constants G_b , a, and G_s , and the required tightness class associated with the minimum tightness.

" G_b " and "a" provide the gasket seating load; similar to Y in the present Code. " G_s " is associated with the operating stress and is similar to the m value in the present Code. The proposed ASME constants G_b , a, and G_s give a design bolt load, obtained by interpretation of

leakage test data as plots of gasket stress, S_g , versus a tightness parameter, T_p . T_p is the pressure (in atmospheres) normalized to the atmospheric pressure required to cause a helium leak rate of 1 mg/sec for a 150 mm OD gasket in a joint. Since this is about the same as the OD of an NPS 4 joint, the pressure to cause a leak of 1 mg/sec of helium for that joint is its tightness. A standard test procedure, the PVRC Room Temperature Tightness Test (ROTT), has been designed to produce the constants G_b , a, and G_s . Low values for G_b , a, and G_s are desirable while a higher value of T_p means a tighter joint.

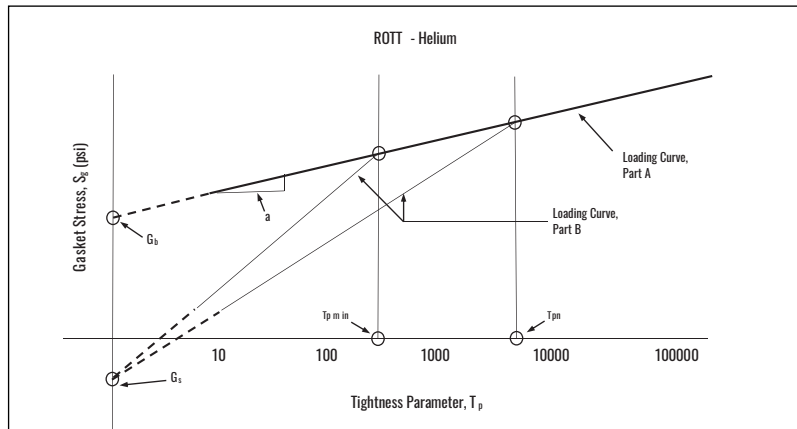

Tightness Class	Mass Leak Rate/Unit Diameter (L_{tm}) mg/sec-min (lb/hr per " of OD)
T1	2×10^{-1} (0.04)
T2	2×10^{-3} (0.0004)
T3	2×10^{-5} (0.000004)
T4	2×10^{-7} (0.00000004)
T5	2×10^{-9} (0.0000000004)

Torque Values - Durlon® Sheet Gasket Material

Pipe Size (in.)	ASME B16.21 Ring Gasket, Ft-Lbs (N-M)					
	Fasteners: A193-B7 or B16 lubricated with a never seize type lubricant, k=0.17					
	Class 150			Class 300		
	Min. ^[1, 2]	Optimal ^[1, 3]	Max. ^[4, 5]	Min. ^[1, 2]	Optimal ^[1, 3]	Max. ^[4, 5]
1/2	10 (14)	25 (33)	25 (33)	10 (14)	25 (34)	25 (34)
3/4	15 (20)	30 (41)	35 (48)	15 (20)	45 (61)	45 (61)
1	15 (20)	35 (48)	50 (68)	20 (27)	55 (75)	60 (81)
1 1/4	25 (34)	45 (61)	75 (102)	35 (47)	80 (108)	90 (122)
1 1/2	30 (41)	60 (82)	80 (109)	50 (68)	140 (190)	145 (197)
2	65 (88)	120 (163)	160 (217)	35 (47)	80 (108)	100 (136)
2 1/2	80 (108)	120 (163)	160 (217)	50 (68)	125 (169)	135 (183)
3	115 (156)	150 (203)	160 (217)	75 (102)	180 (244)	200 (271)
3 1/2	65 (88)	120 (163)	160 (217)	85 (115)	180 (244)	225 (305)
4	80 (109)	120 (163)	160 (217)	105 (142)	215 (292)	285 (386)
5	120 (163)	215 (292)	280 (380)	140 (190)	215 (292)	285 (386)
6	155 (211)	230 (312)	285 (386)	120 (163)	195 (264)	285 (386)
8	215 (291)	285 (386)	285 (386)	195 (264)	315 (427)	460 (624)
10	210 (284)	345 (468)	460 (624)	215 (292)	385 (522)	490 (664)
12	280 (380)	400 (542)	460 (624)	330 (447)	570 (773)	735 (997)
14	355 (481)	515 (698)	685 (929)	295 (400)	570 (773)	640 (868)
16	340 (461)	515 (698)	675 (915)	420 (569)	795 (1078)	900 (1220)
18	500 (678)	755 (1024)	1010 (1369)	465 (630)	885 (1200)	1020 (1383)
20	160 (217)	755 (1024)	1010 (1369)	530 (719)	885 (1200)	1120 (1519)
22	610 (827)	1060 (1437)	1415 (1918)	760 (1030)	1425 (1932)	1600 (2169)
24	670 (909)	1060 (1437)	1415 (1918)	850 (1152)	1425 (1932)	1740 (2359)

Disclaimer: This is a general guide only and TFC/GRI, does not accept responsibility for negligence or misuse of this information.

General Notes:

- a) Torque Values are in ft.-lbs. and assume new A193 Gr. B7 or B16 fasteners with 2H heavy hex nuts; with studs, nuts and the nut bearing surfaces lubricated with a never-seize type lubricant (k = 0.17).
- b) A193 Gr. B7 & B16 fasteners have the same yield strength up to 4" diameter. There are "no" fasteners above 4" diameter in this chart.
- c) All torque values are based on using a "calibrated" torque wrench.
- d) All torque values in the chart above are based on using the tensile area of the fastener.
- e) All torque values in chart are rounded to nearest 5 ft.-lbs.

Footnotes:

^[1] Torque values are based using ASME B16.5-2017 MAWP (Maximum Allowable Working Pressure) at ambient in the gasket stress calculation.

Min. Torque Values:

^[2] Min. torque values are based achieving 4,800 psi gasket stress without exceeding 80,000 psi bolt stress or PCC-1 2019 FEA SA105 Max. Stud Stress Before Flange Yielding.

Optimal Torque Values:

^[3] Optimal torque values are based on a target of 7,000 to 12,000 psi optimum gasket stress without exceeding 80,000 psi bolt stress or PCC-1 2019 FEA SA105 Max. Stud Stress Before Flange Yielding.

- Cases where torque equals ≤ 60,000 bolts stress
- Cases where torque equals > 60,000 ≤ 75,000 bolts stress
- Cases where torque equals > 75,000 ≤ 80,000 bolts stress

Max. Torque Values:

^[4] Max. torque values are based on; max allowable 15,000 psi gasket stress; PCC-1 2019 FEA SA105 Max. Stud Stress Before Flange Yielding, or 80,000 psi bolt stress, whichever occurs 1st. Note: In some cases the max. torque values may be equal to the optimal torque values in order to optimize gasket stress levels.

^[5] 1/2" through 1 1/2" NPS & 3 1/2" NPS due to "No Data" on flange yielding; Max. torque values are set to achieve max gasket stress of 15,000 or 80,000 psi bolt stress, whichever occurs 1st.

- Cases where torque is based on 80,000 bolts stress.
- Cases where torque is based on PCC-1 2019 FEA SA105 Max. Stud Stress Before Flange Yielding.
- Cases where torque is based on max. allowable 15,000 psi gasket stress.

Torque Values - Durlon® Spiral Wound Gaskets – Class 150 & 300

Pipe Size (in.)	ASME B16.20 SWG Gasket, Ft-Lbs (N-M)					
	Fasteners: A193-B7 or B16 lubricated with a never seize type lubricant, k = 0.17					
	Class 150			Class 300		
	Min. [1, 2]	Optimal [1, 3]	Max. [4, 5]	Min. [1, 2]	Optimal [1, 3]	Max. [4, 5]
1/2	20 (27)	35 (47)	55 (75)	20 (27)	35 (47)	55 (75)
3/4	25 (34)	50 (68)	80 (109)	30 (41)	65 (88)	100 (136)
1	35 (47)	70 (95)	80 (109)	45 (61)	90 (122)	135 (183)
1 1/4	40 (54)	*75 (102)	80 (109)	50 (68)	100 (136)	150 (203)
1 1/2	55 (75)	*75 (102)	80 (109)	85 (115)	165 (224)	250 (339)
2	90 (122)	*150 (203)	160 (217)	45 (61)	90 (122)	115 (156)
2 1/2	105 (142)	*150 (203)	160 (217)	65 (88)	125 (169)	170 (230)
3	150 (203)	**150 (203)	160 (217)	100 (136)	185 (251)	225 (305)
3 1/2	85 (116)	*150 (203)	160 (217)	110 (149)	210 (285)	285 (386)
4	110 (150)	*150 (203)	160 (217)	145 (197)	*265 (359)	285 (386)
5	160 (218)	*265 (359)	280 (380)	180 (244)	*265 (359)	285 (386)
6	230 (313)	**265 (359)	285 (386)	170 (230)	*265 (359)	285 (386)
8	285 (386)	***285 (386)	285 (386)	285 (386)	*430 (583)	460 (624)
10	315 (427)	*430 (583)	460 (624)	310 (420)	560 (759)	675 (915)
12	430 (583)	**435 (590)	460 (624)	480 (651)	865 (1173)	990 (1342)
14	545 (739)	*645 (875)	685 (929)	425 (576)	760 (1030)	795 (1078)
16	545 (739)	**645 (875)	675 (915)	635 (861)	*1105 (1498)	1115 (1512)
18	870 (1180)	**945 (1281)	1005 (1363)	740 (1003)	*1200 (1627)	1210 (1641)
20	775 (1051)	*945 (1281)	1005 (1363)	830 (1125)	*1290 (1749)	1300 (1763)
22	635 (861)	*930 (1261)	1415 (1918)	1050 (1424)	*1830 (2481)	2330 (3159)
24	1135 (1539)	**1325 (1796)	1415 (1918)	1325 (1796)	*2150 (2915)	2165 (2935)

Disclaimer: This is a general guide only and TFC/GRI, does not accept responsibility for negligence or misuse of this information.

General Notes:

- a) Torque Values are in ft.-lbs. and assume new A193 Gr. B7 or B16 fasteners with 2H heavy hex nuts; with studs, nuts and the nut bearing surfaces lubricated with a never-seize type lubricant (k = 0.17).
- b) A193 Gr. B7 & B16 fasteners have the same yield strength up to 4" diameter. There are "no" fasteners above 4" diameter in this chart.
- c) All torque values are based on using a "calibrated" torque wrench.
- d) All torque values in the chart above are based on the use of an inner/outer ring style (DRI) spiral wound gasket.
- e) All torque values in the chart above are based on using the tensile area of the fastener.
- f) All torque values in chart are rounded to nearest 5 ft.-lbs.

Footnotes:

^[1] Torque values are based using ASME B16.5-2017 MAWP (Maximum Allowable Working Pressure) at ambient in the gasket stress calculation.

Min. Torque Values:

^[2] Min. torque values are based achieving 12,500 psi gasket stress or at minimum above 10,000 psi gasket stress without exceeding 80,000 psi bolt stress or PCC-1 2019 FEA SA105 Max. Stud Stress Before Flange Yielding.

 Cases where gasket stress is >10,000 < 12,500 psi

Optimal Torque Values:

^[3] Optimal torque values are based on 25,000 psi optimum gasket stress without exceeding 80,000 psi bolt stress or 500 psi below PCC-1 2019 FEA SA105 Max. Stud Stress Before Flange Yielding.

 Cases where torque equals ≤ 60,000 bolts stress

 Cases where torque equals > 60,000 ≤ 75,000 bolts stress

 Cases where torque equals > 75,000 ≤ 80,000 bolts stress

*Cases where gasket stress is ≥ 15,000 < 25,000 psi, **Cases where gasket stress is ≥ 12,500 < 15,000 psi, ***Cases where gasket stress is ≥ 10,000 < 12,500 psi

Max. Torque Values:

^[4] Max. torque values are based on; max allowable 40,000 psi gasket stress; PCC-1 2019 FEA SA105 Max. Stud Stress Before Flange Yielding, or 80,000 psi bolt stress, whichever occurs 1st. Note: In some cases the max. torque values may be equal to the optimal torque values in order to optimize gasket stress levels.

^[5] 1/2" through 1 1/2" NPS & 3 1/2" NPS due to "No Data" on flange yielding; Max. torque values are set to achieve max gasket stress of 40,000 or 80,000 psi bolt stress, whichever occurs 1st.

 Cases where torque is based on 80,000 bolts stress.

 Cases where torque is based on PCC-1 2019 FEA SA105 Max. Stud Stress Before Flange Yielding.

 Cases where torque is based on max. allowable 40,000 psi gasket stress.

Torque Values - Durlon® Spiral Wound Gaskets – Class 400 & 600

Pipe Size (in.)	ASME B16.20 SWG Gasket, Ft.-Lbs (N-M)					
	Fasteners: A193-B7 or B16 lubricated with a never seize type lubricant, k = 0.17					
	Class 400			Class 600		
	Min. [1, 2]	Optimal [1, 3]	Max. [4, 5]	Min. [1, 2]	Optimal [1, 3]	Max. [4, 5]
1/2	20 (27)	35 (47)	55 (75)	20 (27)	35 (47)	55 (75)
3/4	35 (47)	65 (88)	100 (136)	35 (47)	65 (88)	100 (136)
1	45 (61)	90 (122)	135 (183)	45 (61)	90 (122)	135 (183)
1 1/4	50 (68)	100 (136)	150 (203)	55 (75)	100 (136)	150 (203)
1 1/2	90 (122)	170 (230)	250 (339)	95 (129)	170 (230)	250 (339)
2	50 (68)	90 (122)	125 (169)	50 (68)	95 (129)	135 (183)
2 1/2	70 (95)	130 (176)	185 (251)	75 (102)	135 (183)	185 (251)
3	100 (136)	190 (258)	260 (353)	110 (149)	195 (264)	275 (373)
3 1/2	180 (244)	345 (468)	455 (617)	190 (258)	355 (481)	455 (617)
4	210 (285)	395 (536)	420 (569)	225 (305)	410 (556)	455 (617)
5	270 (366)	*430 (583)	455 (617)	335 (454)	600 (813)	685 (929)
6	250 (339)	*430 (583)	455 (617)	305 (414)	550 (746)	685 (929)
8	405 (549)	*645 (875)	685 (929)	500 (678)	880 (1193)	1005 (1363)
10	475 (644)	*785 (1064)	795 (1078)	580 (786)	1010 (1369)	1370 (1857)
12	705 (956)	**735 (997)	745 (1010)	620 (841)	1070 (1451)	1300 (1763)
14	600 (813)	*885 (1200)	930 (1261)	735 (997)	1250 (1695)	1620 (2196)
16	860 (1166)	*1250 (1695)	1260 (1708)	1045 (1417)	1775 (2407)	2165 (2935)
18	920 (1247)	*1440 (1952)	1515 (2054)	1455 (1973)	2470 (3349)	3195 (4332)
20	1135 (1539)	*1650 (2237)	1665 (2257)	1385 (1878)	2305 (3125)	2930 (3973)
22	1230 (1668)	*2075 (2813)	2145 (2908)	1535 (2081)	*2450 (3322)	2905 (3939)
24	1670 (2264)	*2450 (3322)	2710 (3674)	2055 (2786)	3335 (4522)	4050 (5491)

Disclaimer: This is a general guide only and TFC/GRI, does not accept responsibility for negligence or misuse of this information.

General Notes:

- a) Torque Values are in ft.-lbs. and assume new A193 Gr. B7 or B16 fasteners with 2H heavy hex nuts; with studs, nuts and the nut bearing surfaces lubricated with a never-seize type lubricant (k = 0.17).
- b) A193 Gr. B7 & B16 fasteners have the same yield strength up to 4" diameter. There are "no" fasteners above 4" diameter in this chart.
- c) All torque values are based on using a "calibrated" torque wrench.
- d) All torque values in the chart above are based on the use of an inner/outer ring style (DRI) spiral wound gasket.
- e) All torque values in the chart above are based on using the tensile area of the fastener.
- f) All torque values in chart are rounded to nearest 5 ft.-lbs.

Footnotes:

[1] Torque values are based using ASME B16.5-2017 MAWP (Maximum Allowable Working Pressure) at ambient in the gasket stress calculation.

Min. Torque Values:

[2] Min. torque values are based achieving 12,500 psi gasket stress or at minimum above 10,000 psi gasket stress without exceeding 80,000 psi bolt stress or PCC-1 2019 FEA SA105 Max. Stud Stress Before Flange Yielding.

Optimal Torque Values:

[3] Optimal torque values are based on 25,000 psi optimum gasket stress without exceeding 80,000 psi bolt stress or 500 psi below PCC-1 2019 FEA SA105 Max. Stud Stress Before Flange Yielding.

- Cases where torque equals ≤ 60,000 bolts stress
- Cases where torque equals > 60,000 ≤ 75,000 bolts stress
- Cases where torque equals > 75,000 ≤ 80,000 bolts stress

*Cases where gasket stress is ≥ 15,000 < 25,000 psi, **Cases where gasket stress is ≥ 12,500 < 15,000 psi, ***Cases where gasket stress is ≥ 10,000 < 12,500 psi

Max. Torque Values:

[4] Max. torque values are based on; max allowable 40,000 psi gasket stress; PCC-1 2019 FEA SA105 Max. Stud Stress Before Flange Yielding, or 80,000 psi bolt stress, whichever occurs 1st. Note: In some cases the max. torque values may be equal to the optimal torque values in order to optimize gasket stress levels.

[5] 1/2" through 1 1/2" NPS & 3 1/2" NPS due to "No Data" on flange yielding; Max. torque values are set to achieve max gasket stress of 40,000 or 80,000 psi bolt stress, whichever occurs 1st.

- Cases where torque is based on 80,000 bolts stress.
- Cases where torque is based on PCC-1 2019 FEA SA105 Max. Stud Stress Before Flange Yielding.
- Cases where torque is based on max. allowable 40,000 psi gasket stress.

Torque Values - Durlon® Spiral Wound Gaskets – Class 900, 1500 & 2500

Pipe Size (in.)	ASME B16.20 SWG Gasket, Ft-Lbs (N-M)								
	Fasteners: A193-B7 or B16 lubricated with a never seize type lubricant, k = 0.17								
	Class 900			Class 1500			Class 2500		
	Min. [1, 2]	Optimal [1, 3]	Max. [4, 5]	Min. [1, 2]	Optimal [1, 3]	Max. [4, 5]	Min. [1, 2]	Optimal [1, 3]	Max. [4, 5]
1/2	30 (41)	55 (75)	85 (115)	30 (41)	55 (75)	85 (115)	35 (47)	60 (81)	85 (115)
3/4	40 (54)	80 (108)	120 (163)	45 (61)	85 (115)	120 (163)	50 (68)	90 (122)	120 (163)
1	70 (95)	130 (176)	190 (258)	75 (102)	135 (183)	190 (258)	85 (115)	145 (197)	190 (258)
1 1/4	110 (149)	210 (285)	315 (427)	120 (163)	220 (298)	315 (427)	155 (210)	270 (366)	360 (488)
1 1/2	160 (217)	305 (414)	450 (610)	175 (237)	315 (427)	450 (610)	225 (305)	385 (522)	505 (685)
2	105 (142)	200 (271)	295 (400)	115 (156)	210 (285)	295 (400)	150 (203)	260 (353)	340 (461)
2 1/2	155 (210)	290 (393)	415 (563)	170 (230)	300 (407)	415 (563)	220 (298)	370 (502)	470 (637)
3	165 (224)	295 (400)	415 (563)	260 (353)	445 (603)	585 (793)	345 (468)	555 (752)	655 (888)
4	315 (427)	555 (752)	750 (1017)	425 (576)	715 (969)	915 (1241)	620 (841)	965 (1308)	1095 (1485)
5	460 (624)	795 (1078)	1060 (1437)	695 (942)	1155 (1566)	1445 (1959)	1000 (1356)	1550 (2102)	1685 (2285)
6	380 (515)	655 (888)	865 (1173)	575 (780)	935 (1268)	1145 (1552)	1565 (2122)	2355 (3193)	2505 (3396)
8	630 (854)	1055 (1430)	1330 (1803)	975 (1322)	1550 (2102)	1830 (2481)	1530 (2074)	*2120 (2874)	2255 (3057)
10	630 (854)	1010 (1369)	1210 (1641)	1575 (2135)	2470 (3349)	2770 (3756)	2690 (3647)	*3225 (4373)	3435 (4657)
12	730 (900)	1190 (1613)	1460 (1979)	1665 (2257)	2510 (3403)	2655 (3600)	4180 (5667)	*5175 (7016)	5510 (7471)
14	905 (1227)	1455 (1973)	1740 (2359)	2055 (2786)	*2665 (3613)	2815 (3817)	-	-	-
16	1205 (1634)	1900 (2576)	2165 (2935)	3125 (4237)	*4480 (6074)	4730 (6413)	-	-	-
18	1910 (2590)	3075 (4169)	3640 (4935)	4445 (6027)	*6230 (8447)	6670 (9043)	-	-	-
20	2235 (3030)	3450 (4678)	3830 (5193)	5680 (7701)	*7600 (10304)	8025 (10880)	-	-	-
24	3680 (4989)	*5425 (7354)	5730 (7769)	9180 (12446)	*11770 (15958)	12415 (16833)	-	-	-

Disclaimer: This is a general guide only and TFC/GRI, does not accept responsibility for negligence or misuse of this information.

General Notes:

- a) Torque Values are in ft.-lbs. and assume new A193 Gr. B7 or B16 fasteners with 2H heavy hex nuts; with studs, nuts and the nut bearing surfaces lubricated with a never-seize type lubricant (k = 0.17).
- b) A193 Gr. B7 & B16 fasteners have the same yield strength up to 4" diameter. There are "no" fasteners above 4" diameter in this chart.
- c) All torque values are based on using a "calibrated" torque wrench.
- d) All torque values in the chart above are based on the use of an inner/outer ring style (DRI) spiral wound gasket.
- e) All torque values in the chart above are based on using the tensile area of the fastener.
- f) All torque values in chart are rounded to nearest 5 ft.-lbs.

Footnotes:

^[1] Torque values are based using ASME B16.5-2017 MAWP (Maximum Allowable Working Pressure) at ambient in the gasket stress calculation.

Min. Torque Values:

^[2] Min. torque values are based achieving 12,500 psi gasket stress or at minimum above 10,000 psi gasket stress without exceeding 80,000 psi bolt stress or PCC-1 2019 FEA SA105 Max. Stud Stress Before Flange Yielding.

Optimal Torque Values:

^[3] Optimal torque values are based on 25,000 psi optimum gasket stress without exceeding 80,000 psi bolt stress or 500 psi below PCC-1 2019 FEA SA105 Max. Stud Stress Before Flange Yielding.

- Cases where torque equals ≤ 60,000 bolts stress
- Cases where torque equals > 60,000 ≤ 75,000 bolts stress
- Cases where torque equals > 75,000 ≤ 80,000 bolts stress

*Cases where gasket stress is ≥ 15,000 < 25,000 psi, **Cases where gasket stress is ≥ 12,500 < 15,000 psi, ***Cases where gasket stress is ≥ 10,000 < 12,500 psi

Max. Torque Values:

^[4] Max. torque values are based on; max allowable 40,000 psi gasket stress; PCC-1 2019 FEA SA105 Max. Stud Stress Before Flange Yielding, or 80,000 psi bolt stress, whichever occurs 1st. Note: In some cases the max. torque values may be equal to the optimal torque values in order to optimize gasket stress levels.

^[5] 1/2" through 1 1/2" NPS & 3 1/2" NPS due to "No Data" on flange yielding; Max. torque values are set to achieve max gasket stress of 40,000 or 80,000 psi bolt stress, whichever occurs 1st.

- Cases where torque is based on 80,000 bolts stress.
- Cases where torque is based on PCC-1 2019 FEA SA105 Max. Stud Stress Before Flange Yielding.
- Cases where torque is based on max. allowable 40,000 psi gasket stress.

Chemical Resistance - Non-Metallic Gaskets

The following information is a general guide only for the selection of a suitable gasket material as there are unlimited combinations of fluid, pressure, and temperature conditions.

A = Acceptable C = Caution-Dependent on Conditions NS = Not Suitable - = No Data Available

Fluid	Durlon® Compressed Non-Asbestos Sheet						Durlon® PTFE				Durlon® Flexible Graphite			Durlon® HT1000®		
	5000 7900 7910 7925 7950	8300 8900	8400	8500	8600	8700	9000 9000N 9002	9200	9400	Virgin Joint Sealant 9600	FGS95	CFG FGL316 FGM316	FGT316	S90	L316	T316
Acetaldehyde	C	NS	C	C	C	C	A	A	A	A	A	A	A	C	C	C
Acetic Acid	C	C	C	C	C	C	A	A	A	A	A	A	A	A	A	A
Acetic Acid (37%)	C	A	A	A	A	A	A	A	A	A	A	A	A	A	A	A
Acetic Anhydride	C	A	C	C	C	C	A	A	A	A	A	A	-	-	-	
Acetone	C	C	C	C	C	C	A	A	A	A	A	A	C	C	C	
Acetonitrile	NS	NS	NS	NS	NS	C	A	A	A	A	NS	NS	NS	-	-	-
Acetylene	A	A	A	A	C	A	A	A	A	A	A	A	A	C	C	C
Acrolein	C	C	C	C	NS	C	A	A	A	A	NS	NS	NS	-	-	-
Acrylic Acid	NS	NS	NS	NS	NS	NS	A	A	A	A	A	NS	NS	-	-	-
Acrylonitrile	NS	NS	NS	NS	NS	NS	A	A	A	A	A	A	A	-	-	-
Air	A	A	A	A	A	A	A	A	A	A	A	A	A	A	A	A
Alum	A	A	A	A	A	A	A	A	A	A	A	A	A	A	A	A
Aluminum Acetate	A	A	A	A	A	A	A	A	A	A	C	C	C	A	A	A
Aluminum Chloride	A	A	A	A	A	A	A	A	A	A	A	A	-	A	-	-
Aluminum Fluoride	NS	NS	NS	NS	NS	NS	-	A	A	A	A	A	-	-	-	-
Aluminum Hydroxide	A	A	A	A	A	A	A	A	A	A	A	NS	NS	A	-	-
Aluminum Nitrate	A	A	A	A	A	A	A	A	NS	A	C	C	C	-	-	-
Aluminum Sulfate	A	A	A	A	A	A	A	A	A	A	A	NS	NS	-	-	-
Amines	C	C	C	C	A	C	A	A	A	A	A	A	A	-	-	-
Ammonia, Gas	C	A	A	A	A	A	-	-	-	-	-	-	-	-	-	-
Ammonia, Gas (<150°F)	C	A	A	A	A	A	A	A	A	A	A	C	C	A	-	-
Ammonia, Gas (>150°F)	NS	NS	NS	NS	NS	C	A	A	A	A	A	NS	NS	A	-	-
Ammonia (Liquid)	C	A	A	A	C	A	-	-	-	-	A	A	-	-	-	-
Ammonia, Liquid, Anhydrous	C	A	A	A	C	A	A	A	A	A	A	A	A	A	A	A
Ammonium Bisulfite	A	A	A	A	C	A	A	A	A	A	NS	NS	NS	-	-	-
Ammonium Chloride	A	A	A	A	A	A	A	A	A	A	A	A	A	A	A	A
Ammonium Hydroxide	A	A	A	A	A	A	A	A	A	A	A	A	A	A	A	A
Ammonium Hydroxide (10%)	A	A	A	A	NS	C	A	A	A	A	-	-	-	-	-	-
Ammonium Hydroxide (Sat'd)	A	A	A	A	NS	C	-	-	-	-	-	-	-	-	-	-
Ammonium Nitrate	C	C	C	C	C	C	A	A	NS	A	A	A	A	-	-	-
Ammonium Phosphate	A	A	A	A	NS	A	A	A	A	A	A	A	A	-	-	-
Ammonium Sulfate	A	A	A	A	A	A	A	A	A	A	A	A	A	-	-	-
Ammonium Sulfide	A	A	A	A	C	A	A	A	A	A	-	-	-	-	-	-
Amyl Chloride	NS	NS	NS	NS	NS	NS	A	A	A	A	A	A	A	A	A	A
Aniline, Aniline Oil	NS	NS	NS	NS	NS	NS	A	A	A	A	A	A	A	C	C	C
Aqua Regia	NS	NS	NS	NS	NS	NS	A	A	NS	A	NS	NS	NS	-	-	-
Arsenic Acid	A	A	A	A	A	A	A	A	A	A	A	A	A	-	-	-
Asphalt	A	A	A	A	NS	NS	A	A	A	A	A	A	A	A	A	A
Aviation Fuels	A	A	A	A	NS	C	A	A	A	A	A	A	A	A	A	A
Baking Soda	A	A	A	A	A	A	A	A	A	A	A	A	A	A	A	A
Barium Chloride	A	A	A	A	A	A	A	A	A	A	A	A	A	A	A	A
Barium Hydroxide	A	A	A	A	A	A	A	A	A	A	A	A	-	-	-	-
Barium Sulfate	A	A	A	A	A	A	-	-	-	-	A	A	-	-	-	-
Barium Sulfide	A	A	A	A	A	A	A	A	A	A	A	A	-	-	-	-
Beer	A	A	A	A	A	A	A	A	A	A	A	A	A	A	A	A
Benzaldehyde	NS	NS	NS	NS	NS	NS	A	A	A	A	A	A	A	-	-	-
Benzene (Benzol)	NS	NS	NS	NS	NS	NS	A	A	A	A	A	A	A	C	C	C
Benzoic Acid	NS	NS	NS	NS	NS	NS	A	A	A	A	A	A	A	A	A	A

Chemical Resistance - Non-Metallic Gaskets

The following information is a general guide only for the selection of a suitable gasket material as there are unlimited combinations of fluid, pressure, and temperature conditions.

A = Acceptable C = Caution-Dependent on Conditions NS = Not Suitable - = No Data Available

Fluid	Durlon® Compressed Non-Asbestos Sheet						Durlon® PTFE				Durlon® Flexible Graphite			Durlon® HT1000®		
	5000 7900 7910 7925 7950	8300 8900	8400	8500	8600	8700	9000 9000N 9002	9200	9400	Virgin Joint Sealant 9600	FGS95	CFG FGL316 FGM316	FGT316	S90	L316	T316
Benzoyl Chloride	NS	NS	NS	NS	NS	NS	A	A	A	A	C	NS	NS	-	-	-
Benzyl Alcohol	NS	NS	NS	NS	NS	C	A	A	A	A	A	C	C	-	-	-
Benzyl Chloride	NS	NS	NS	NS	NS	NS	A	A	A	A	A	A	A	-	-	-
Black Sulfate Liquor	C	NS	A	A	NS	NS	C	A	A	A	-	-	-	-	-	-
Black Sulfate Liquor (<350°F)	A	NS	A	A	C	C	A	A	A	A	C	C	C	C	C	C
Black Sulfate Liquor (>350°F)	NS	NS	C	NS	NS	NS	A	A	A	A	NS	NS	NS	NS	NS	NS
Bleach Solutions	C	C	A	C	C	C	A	A	A	A	C	NS	NS	A	-	-
Boiler Feed Water	A	A	A	A	A	A	A	A	A	A	A	A	A	A	A	A
Borax	A	A	A	A	A	A	A	A	A	A	A	A	A	A	A	A
Boric Acid	A	A	A	A	A	A	A	A	A	A	A	A	A	A	A	A
Brine	A	A	A	A	A	A	A	A	A	A	A	C	C	-	-	-
Bromine (Liquid)	NS	NS	NS	NS	NS	NS	A	A	A	A	-	-	-	-	-	-
Bromine (Gas)	NS	NS	NS	NS	NS	NS	A	A	A	A	-	-	-	-	-	-
Butadiene	NS	NS	NS	NS	NS	NS	A	A	A	A	A	A	A	A	A	A
Butane	A	A	A	A	NS	C	A	A	A	A	A	A	A	A	A	A
2-Butanone	NS	NS	NS	NS	NS	NS	A	A	A	A	A	A	A	C	C	C
Butyl Acetate	NS	NS	NS	NS	NS	NS	A	A	A	A	A	A	A	C	C	C
Butyl Alcohol (Butanol)	A	A	A	A	A	A	A	A	A	A	A	A	A	C	C	C
n-Butyl Amine	C	C	C	C	NS	NS	A	A	A	A	A	A	A	C	C	C
tert-Butyl Amine	C	C	C	C	NS	NS	A	A	A	A	A	A	A	-	-	-
Butyl Methacrylate	NS	NS	NS	NS	NS	NS	A	A	A	A	C	NS	NS	-	-	-
Butylene (Butene)	A	A	A	A	NS	C	A	A	A	A	A	A	A	-	-	-
Butyric Acid	A	A	A	A	C	C	A	A	A	A	A	A	A	C	C	C
Calcium Bisulfite	A	A	A	A	NS	C	A	A	A	A	A	A	A	-	-	-
Calcium Carbonate	A	A	A	A	A	A	A	A	A	A	A	A	A	-	-	-
Calcium Chlorate	A	A	A	A	NS	A	-	-	-	-	Y	-	-	-	-	-
Calcium Chloride	A	A	A	A	A	A	A	A	A	A	A	A	A	A	A	A
Calcium Hydroxide	A	A	A	A	A	A	A	A	A	A	A	A	A	A	A	A
Calcium Hypochlorite	C	C	A	C	C	C	A	A	A	A	A	A	A	A	A	A
Calcium Nitrate	A	A	A	A	A	A	A	A	NS	A	A	A	A	-	-	-
Calcium Sulfate	A	A	A	A	NS	C	-	-	-	-	A	A	A	A	-	-
Caprolactam	NS	NS	NS	NS	NS	NS	A	A	A	A	NS	NS	NS	-	-	-
Carbon Dioxide, dry	A	A	A	A	C	C	A	A	A	A	A	A	A	A	A	A
Carbon Dioxide, wet	A	A	A	A	C	C	A	A	A	A	A	A	A	A	A	A
Carbon Disulfide	NS	NS	C	NS	NS	NS	A	A	A	A	A	A	A	C	C	C
Carbon Monoxide	A	A	A	A	NS	NS	A	A	A	A	A	A	A	A	A	A
Carbon Tetrachloride	C	NS	C	C	NS	NS	A	A	A	A	A	A	A	C	C	C
Castor Oil	A	A	A	A	C	C	A	A	A	A	A	A	A	A	-	-
Caustic Potash	A	A	A	A	NS	NS	A	A	A	A	A	A	A	A	A	A
Caustic Soda (NaOH)	C	NS	A	C	C	NS	C	A	A	A	A	A	C	A	A	A
Chloric Acid (10%)	NS	NS	NS	NS	NS	NS	-	-	-	-	-	-	-	-	-	-
Chloric Acid (20%)	NS	NS	NS	NS	NS	NS	-	-	-	-	-	-	-	-	-	-
Chlorine, liquid (Dry)	NS	NS	NS	NS	NS	NS	A	A	A	A	A	C	C	-	-	-
Chlorine Liquid	NS	NS	C	NS	NS	NS	A	A	A	A	A	NS	NS	-	-	-
Chlorine Dioxide	NS	NS	NS	NS	NS	NS	A	A	NS	A	C	NS	NS	-	-	-
Chlorine Gas (Dry)	NS	NS	NS	NS	NS	NS	A	A	A	A	-	-	-	-	-	-
Chlorine Gas (Wet)	NS	NS	NS	NS	NS	NS	A	A	A	A	-	-	-	-	-	-
Chlorinated Water (<3500ppm)	NS	NS	NS	NS	NS	NS	A	A	A	A	-	-	-	-	-	-

Chemical Resistance - Non-Metallic Gaskets

The following information is a general guide only for the selection of a suitable gasket material as there are unlimited combinations of fluid, pressure, and temperature conditions.

A = Acceptable C = Caution-Dependent on Conditions NS = Not Suitable - = No Data Available

Fluid	Durlon® Compressed Non-Asbestos Sheet						Durlon® PTFE				Durlon® Flexible Graphite			Durlon® HT1000®		
	5000 7900 7910 7925 7950	8300 8900	8400	8500	8600	8700	9000 9000N 9002	9200	9400	Virgin Joint Sealant 9600	FGS95	CFG FGL316 FGM316	FGT316	S90	L316	T316
Chlorinated Water (>3500ppm)	NS	NS	NS	NS	NS	NS	A	A	A	A	-	-	-	-	-	-
Chlorobenzene	NS	NS	NS	NS	NS	NS	A	A	A	A	A	A	A	-	-	-
Chloroethane	NS	NS	NS	NS	NS	NS	A	A	A	A	A	A	A	-	-	-
Chloroethylene	NS	NS	NS	NS	NS	NS	A	A	A	A	A	C	C	-	-	-
Chloroform	C	C	A	C	NS	NS	A	A	A	A	A	A	A	C	C	C
Chlorosulfonic Acid	NS	NS	NS	NS	NS	NS	A	A	-	A	A	-	-	-	-	-
Chromic Acid	NS	NS	NS	NS	NS	NS	A	A	NS	A	A	A	A	C	C	C
Chromic Acid (10%)	-	-	-	-	-	-	A	A	-	A	-	-	-	-	-	-
Chromic Acid (30%)	-	-	-	-	-	-	A	A	-	A	-	-	-	-	-	-
Chromic Acid (40%)	-	-	-	-	-	-	A	A	-	A	-	-	-	-	-	-
Chromic Acid (50%)	-	-	-	-	-	-	A	A	-	A	-	-	-	-	-	-
Citric Acid	A	A	A	A	A	A	A	A	A	A	A	A	A	A	A	A
Coal Gas	A	A	A	A	NS	C	A	A	A	A	A	A	A	A	A	A
Coconut Oil	A	A	A	A	NS	C	A	A	-	-	A	A	A	-	-	-
Coke Oven Gas	NS	NS	NS	NS	NS	NS	A	A	A	A	-	-	-	-	-	-
Copper Acetate	A	A	A	A	NS	A	-	-	-	-	A	A	A	A	-	-
Copper Chloride	A	A	A	A	A	A	A	A	A	A	-	-	-	-	-	-
Copper Sulfate	A	A	A	A	A	A	A	A	A	A	A	A	A	A	A	A
Corn Oil	C	A	C	C	NS	C	A	A	A	A	A	A	A	A	A	A
Cotton Seed Oil	A	A	A	A	NS	C	A	A	A	A	A	A	A	A	A	A
Cresote (Coal Tar)	A	A	A	A	NS	NS	A	A	A	A	A	A	A	A	A	A
Cresol	C	C	A	C	NS	NS	A	A	A	A	A	A	A	A	A	A
Crude Oil	A	A	A	A	NS	C	A	A	A	A	A	A	A	A	A	A
Cumene	NS	NS	NS	NS	NS	C	A	A	A	A	-	-	-	-	-	-
Cyclohexane	C	A	A	C	NS	C	A	A	A	A	A	A	A	-	-	-
Cyclohexanone	NS	NS	NS	NS	NS	NS	A	A	A	A	A	A	A	A	A	A
Detergent Solutions	A	A	A	A	A	A	A	A	A	A	A	A	A	A	A	A
Diacetone Alcohol	NS	NS	NS	NS	NS	NS	A	A	A	A	A	A	A	-	-	-
Diazomethane	NS	NS	NS	NS	NS	NS	A	A	A	A	NS	NS	NS	-	-	-
Dibenzyl Ether	C	NS	C	C	NS	NS	A	A	A	A	A	NS	NS	C	NS	NS
Dibutylamine	C	C	C	C	NS	C	A	A	A	A	-	-	-	-	-	-
Dichlorobenzene	NS	NS	NS	NS	NS	NS	A	A	A	A	A	A	A	-	-	-
Dichlorobenzidene	NS	NS	NS	NS	NS	NS	A	A	A	A	NS	NS	NS	-	-	-
Dichloroethylene	NS	NS	NS	NS	NS	NS	A	A	A	A	A	A	A	-	-	-
Dichloroethyl Ether	NS	NS	NS	NS	NS	NS	A	A	A	A	-	-	-	-	-	-
Dichloromethane	NS	NS	NS	NS	NS	NS	A	A	A	A	A	NS	NS	-	-	-
Diesel Fuel	A	A	A	A	C	C	A	A	A	A	A	A	A	A	A	A
Dimethylamine	NS	NS	NS	NS	NS	NS	A	A	A	A	-	-	-	-	-	-
Diethyl Carbonate	NS	NS	NS	NS	NS	NS	A	A	A	A	A	NS	NS	-	-	-
Dimethyl Acetamide	NS	NS	C	NS	NS	NS	A	A	A	A	-	-	-	-	-	-
Dimethylformamide (DMF)	NS	NS	C	NS	NS	NS	A	A	A	A	-	-	-	-	-	-
Dioxane	NS	NS	NS	NS	NS	NS	A	A	A	A	A	-	-	-	-	-
Dowtherm A, E	C	NS	C	C	NS	NS	A	A	A	A	A	A	A	-	-	-
Dowtherm J	NS	NS	NS	NS	NS	NS	A	A	A	A	A	A	A	-	-	-
Epichlorohydrin	NS	NS	NS	NS	NS	NS	A	A	A	A	A	C	C	-	-	-
Ethane	A	A	A	A	C	C	A	A	A	A	A	A	A	A	A	A
Ether	NS	NS	NS	NS	NS	NS	A	A	A	A	A	A	A	-	-	-
Ethyl Acetate	C	C	C	C	C	NS	A	A	A	A	A	A	A	C	C	C

Chemical Resistance - Non-Metallic Gaskets

The following information is a general guide only for the selection of a suitable gasket material as there are unlimited combinations of fluid, pressure, and temperature conditions.

A = Acceptable C = Caution-Dependent on Conditions NS = Not Suitable - = No Data Available

Fluid	Durlon® Compressed Non-Asbestos Sheet						Durlon® PTFE				Durlon® Flexible Graphite			Durlon® HT1000®		
	5000 7900 7910 7925 7950	8300 8900	8400	8500	8600	8700	9000 9000N 9002	9200	9400	Virgin Joint Sealant 9600	FGS95	CFG FGL316 FGM316	FGT316	S90	L316	T316
Ethyl Alcohol (Ethanol)	A	A	A	A	A	A	A	A	A	A	A	A	A	C	C	C
Ethylbenzene	NS	NS	NS	NS	NS	NS	A	A	A	A	A	A	A	-	-	-
Ethylchloride	NS	NS	A	NS	NS	NS	A	A	A	A	A	A	A	C	C	C
Ethylene	A	A	A	A	NS	C	A	A	A	A	A	A	A	C	C	C
Ethylene Bromide	NS	NS	NS	NS	NS	NS	A	A	A	A	A	-	-	-	-	-
Ethylene Dichloride (EDC)	NS	NS	NS	NS	NS	NS	A	A	A	A	A	A	A	-	-	-
Ethylene Glycol	A	A	A	A	A	A	A	A	A	A	A	A	A	A	A	A
Ethyl Ether	C	C	C	C	NS	C	A	A	A	A	A	A	A	C	C	C
Ethylene Oxide	NS	NS	NS	NS	NS	NS	A	A	A	A	A	A	A	-	-	-
Fatty Acids	A	A	A	A	NS	C	A	A	A	A	A	A	A	A	A	A
Ferric Chloride	A	A	A	A	A	A	A	A	A	A	A	NS	NS	-	-	-
Ferric Hydroxide	A	A	A	A	NS	A	-	-	-	-	-	-	-	-	-	-
Ferric Nitrate	A	A	A	A	A	A	-	-	-	-	A	A	-	-	-	-
Ferrous Chloride	A	A	A	A	A	A	A	A	A	A	A	NS	NS	-	-	-
Ferrous Sulfate	A	A	A	A	A	A	-	-	-	-	C	C	C	-	-	-
Fish Oil	A	A	A	A	NS	A	-	-	-	-	A	-	-	-	-	-
Flue Gas	A	A	A	A	NS	NS	-	-	-	-	A	-	-	-	-	-
Fluorine Gas (Dry)	NS	NS	NS	NS	NS	NS	NS	NS	C	A	A	-	-	-	-	-
Fluorine Gas (Wet)	NS	NS	NS	NS	NS	NS	NS	NS	C	A	-	-	-	-	-	-
Formaldehyde	A	A	C	A	C	C	A	A	A	A	A	A	A	C	C	C
Formic Acid	NS	NS	NS	NS	C	A	A	A	A	A	A	A	A	A	A	A
Freon (See Refrigerants)	-	-	-	-	-	-	-	-	-	-	-	-	-	-	-	-
Fuel Oil	A	A	A	A	NS	C	A	A	A	A	A	A	A	A	A	A
Gas, Natural	A	A	A	A	NS	A	A	A	A	A	A	A	A	A	A	A
Gasoline	A	A	A	A	NS	NS	A	A	A	A	A	A	A	C	C	C
Gasoline Sour	A	A	A	A	NS	C	A	A	A	A	-	-	-	-	-	-
Gelatin	A	A	A	A	A	A	A	A	A	A	A	A	-	-	-	-
Glucose	A	A	A	A	A	A	A	A	A	A	A	A	A	A	A	A
Glycerin (Glycerol)	A	A	A	A	A	A	A	A	A	A	A	A	A	A	A	A
Green Sulfate Liquor	C	C	A	C	NS	C	A	A	A	A	C	C	C	-	-	-
Glycol	A	A	A	A	A	A	A	A	A	A	A	C	C	A	C	C
Heptane	A	A	A	A	NS	C	A	A	A	A	A	A	A	A	A	A
Hexane	A	A	A	A	NS	C	A	A	A	A	A	A	A	A	A	A
Hydraulic Oil (Mineral)	A	A	A	A	C	C	A	A	A	A	A	A	A	A	A	A
Hydraulic Oil (Phosp. Ester)	C	C	C	C	NS	NS	A	A	A	A	A	A	A	A	A	A
Hydrazine	C	C	A	C	C	C	A	A	A	A	A	A	A	A	A	A
Hydrochloric Acid	NS	NS	C	NS	NS	NS	A	A	A	A	-	-	-	-	-	-
Hydrochloric Acid (30%)	NS	NS	C	NS	NS	NS	A	A	A	A	A	NS	NS	A	NS	NS
Hydrofluoric Acid	NS	NS	NS	NS	NS	NS	NS	NS	A	A	A	NS	NS	-	-	-
Hydrogen	A	A	A	A	A	A	A	A	A	A	A	A	A	A	A	A
Hydrogen Chloride, (Dry)	NS	A	NS	NS	NS	NS	A	A	A	A	A	NS	NS	-	-	-
Hydrogen Fluoride (HF)	NS	NS	NS	NS	NS	NS	NS	NS	A	A	A	NS	NS	A	NS	NS
Hydrogen Peroxide (10%)	C	C	C	C	C	C	A	A	A	A	C	C	C	A	A	A
Hydrogen Peroxide (50%)	NS	NS	NS	NS	NS	NS	A	A	-	A	-	-	-	-	-	-
Hydrogen Peroxide (90%)	NS	NS	NS	NS	NS	NS	A	A	-	A	-	-	-	-	-	-
Hydrogen Sulfide (Dry)	C	A	A	C	C	A	A	A	A	A	A	A	A	-	-	-
Hydrogen Sulfide (Wet)	C	C	C	C	NS	C	A	A	A	A	A	A	A	-	-	-

Chemical Resistance - Non-Metallic Gaskets

The following information is a general guide only for the selection of a suitable gasket material as there are unlimited combinations of fluid, pressure, and temperature conditions.

A = Acceptable C = Caution-Dependent on Conditions NS = Not Suitable - = No Data Available

Fluid	Durlon® Compressed Non-Asbestos Sheet						Durlon® PTFE				Durlon® Flexible Graphite			Durlon® HT1000®		
	5000 7900 7910 7925 7950	8300 8900	8400	8500	8600	8700	9000 9000N 9002	9200	9400	Virgin Joint Sealant 9600	FGS95	CFG FGL316 FGM316	FGT316	S90	L316	T316
Hydroquinone	NS	NS	NS	NS	C	NS	A	A	A	A	A	A	A	-	-	-
Iodine	A	A	A	A	A	NS	A	A	A	A	NS	NS	NS	-	-	-
Isobutane	A	A	A	A	NS	C	A	A	A	A	A	-	-	-	-	-
Isooctane	A	A	A	A	NS	C	A	A	A	A	A	A	A	A	A	A
Isopropyl Alcohol	A	A	A	A	A	A	A	A	A	A	A	A	A	C	C	C
Isopropyl Ether	A	A	A	A	NS	NS	A	A	-	-	A	A	-	-	-	-
Jet Fuel	A	A	A	A	NS	C	A	A	A	A	A	A	A	A	A	A
Kerosene	A	A	A	A	NS	C	A	A	A	A	A	A	A	A	A	A
Lacquer Solvents	NS	NS	NS	NS	NS	NS	A	A	A	A	A	A	A	A	A	A
Lactic Acid	A	A	A	A	A	A	A	A	A	A	A	A	A	A	A	A
Lead Sulfate	A	A	A	A	NS	A	-	-	-	-	-	-	-	-	-	-
Linoleic Acid	C	C	C	C	NS	NS	-	-	-	-	-	-	-	-	-	-
Linseed Oil	A	A	A	A	NS	C	A	A	A	A	A	A	A	A	A	A
Lubricating Oil	A	A	A	A	NS	C	A	A	A	A	A	A	A	A	A	A
Magnesium Carbonate	A	A	A	A	A	A	-	-	-	-	-	-	-	-	-	-
Magnesium Chloride	A	A	A	A	A	A	A	A	A	A	A	NS	NS	-	-	-
Magnesium Hydroxide	A	A	A	A	A	A	A	A	A	A	A	A	A	-	-	-
Magnesium Sulfate	A	A	A	A	A	A	A	A	A	A	A	A	A	A	A	A
Maleic Acid	A	A	A	A	C	NS	A	A	A	A	A	A	A	A	A	A
Maleic Anhydride	NS	NS	NS	NS	NS	NS	A	A	A	A	NS	NS	NS	-	-	-
Mercuric Chloride	A	A	A	A	A	C	A	A	A	A	NS	NS	NS	-	-	-
Mercury	A	A	A	A	A	A	A	A	A	A	-	-	-	-	-	-
Methane	A	A	A	A	NS	C	A	A	A	A	A	A	A	C	C	C
Methanol	A	A	A	A	A	A	A	A	A	A	A	A	A	C	C	C
Methylacrylic Acid	NS	NS	NS	NS	NS	NS	A	A	A	A	-	-	-	-	-	-
Methyl Acetone	NS	NS	NS	NS	NS	NS	A	A	-	-	-	-	-	-	-	-
Methyl Alcohol	A	A	A	A	A	A	A	A	A	A	A	A	A	C	C	C
Methyl Amine	C	C	C	C	NS	C	-	-	-	-	-	-	-	-	-	-
Methylene Chloride	NS	NS	NS	NS	NS	NS	A	A	A	A	A	NS	NS	C	NS	NS
Methyl Ethyl Ketone, MEK	NS	NS	NS	NS	NS	NS	A	A	A	A	A	A	A	C	C	C
Methyl Isobutyl Ketone	NS	NS	NS	NS	NS	NS	A	A	A	A	A	A	A	-	-	-
Methyl Chloride	NS	NS	NS	NS	NS	NS	A	A	A	A	-	-	-	C	-	-
Methyl Isocyanate	NS	NS	NS	NS	NS	NS	A	A	A	A	NS	NS	NS	-	-	-
Methyl Methacrylate	NS	NS	NS	NS	NS	NS	A	A	A	A	NS	NS	NS	-	-	-
Milk	A	A	A	A	A	A	A	A	A	A	A	A	A	A	A	A
Mineral Oil	A	A	A	A	NS	C	A	A	A	A	A	A	A	A	A	A
Muriatic Acid	NS	NS	C	NS	NS	NS	A	A	A	A	A	NS	NS	-	-	-
Naphtha	A	A	A	A	C	NS	A	A	A	A	A	A	A	A	A	A
Naphthalene	NS	NS	NS	NS	NS	NS	A	A	A	A	A	A	A	-	-	-
Natural Gas	A	A	A	A	NS	A	A	A	A	A	A	A	A	A	A	A
Nickel Ammonium Sulfate	NS	NS	NS	NS	NS	NS	-	-	-	-	-	-	-	-	-	-
Nickel Nitrate	A	A	A	A	A	A	-	-	-	-	-	-	-	-	-	-
Nickel Sulfate	A	A	A	A	A	A	A	A	A	A	A	A	A	-	-	-
Nitric Acid	NS	NS	NS	NS	NS	NS	A	A	NS	A	NS	NS	NS	-	-	-
Nitric Acid (< 20%)	NS	NS	NS	NS	NS	NS	A	A	NS	A	A	A	A	A	A	A
Nitric Acid (50%)	NS	NS	NS	NS	NS	NS	A	A	NS	A	NS	NS	NS	A	A	A
Nitrobenzene	NS	NS	NS	NS	NS	NS	A	A	A	A	A	A	A	A	A	A
Nitrogen	A	A	A	A	A	A	A	A	A	A	A	A	A	A	A	A

Chemical Resistance - Non-Metallic Gaskets

The following information is a general guide only for the selection of a suitable gasket material as there are unlimited combinations of fluid, pressure, and temperature conditions.

A = Acceptable C = Caution-Dependent on Conditions NS = Not Suitable - = No Data Available

Fluid	Durlon® Compressed Non-Asbestos Sheet						Durlon® PTFE				Durlon® Flexible Graphite			Durlon® HT1000®		
	5000 7900 7910 7925 7950	8300 8900	8400	8500	8600	8700	9000 9000N 9002	9200	9400	Virgin Joint Sealant 9600	FGS95	CFG FGL316 FGM316	FGT316	S90	L316	T316
Nitrogen Dioxide	NS	NS	NS	NS	NS	NS	A	A	NS	A	-	-	-	-	-	-
Nitrogen Tetroxide	NS	NS	NS	NS	NS	NS	A	A	NS	A	-	-	-	-	-	-
Nitrous Acid (10%)	NS	NS	NS	NS	NS	NS	-	-	-	-	-	-	-	-	-	-
Nitrous Oxide	A	A	A	A	NS	A	-	-	-	-	-	-	-	-	-	-
Octane	A	A	A	A	NS	C	A	A	A	A	A	A	A	A	A	A
Oil, Crude	A	A	A	A	NS	C	A	A	A	A	A	A	A	A	A	A
Oil, Mineral	A	A	A	A	NS	C	A	A	A	A	A	A	A	A	A	A
Oleic Acid	C	C	C	C	NS	C	A	A	A	A	A	A	A	A	A	A
Oleum, Fuming H2SO4	NS	NS	NS	NS	NS	NS	A	NS	-	A	NS	NS	NS	A	-	-
Olive Oil	A	A	A	A	NS	A	-	-	-	-	A	A	A	-	-	-
Oxalic Acid	C	A	A	C	NS	C	A	A	A	A	A	A	A	A	A	A
Oxalic Acid (50%)	A	A	A	A	C	C	-	-	-	-	-	-	-	-	-	-
Oxygen, gas***	NS	NS	NS	NS	NS	NS	A	A	NS	A	A	NS	A	-	-	-
Oxygen, liquid***	NS	NS	NS	NS	NS	NS	A	A	NS	A	A	NS	A	-	-	-
Ozone	NS	NS	NS	NS	NS	NS	A	A	C	A	NS	NS	NS	-	-	-
Paraffin	A	A	A	A	NS	C	A	A	A	A	A	A	A	-	-	-
Pentane	A	A	A	A	NS	C	A	A	A	A	A	C	C	-	-	-
Perchloroethylene	NS	NS	NS	NS	NS	NS	A	A	A	A	A	A	A	C	C	C
Petroleum	A	A	A	A	NS	C	A	A	A	A	A	A	A	A	A	A
Phenol	NS	NS	NS	NS	NS	NS	A	A	A	A	A	A	A	A	A	A
Phosphoric Acid	C	C	C	C	NS	C	C	A	A	A	A	A	A	A	A	A
Phosphoric Acid (45%)	C	C	C	C	NS	C	A	A	A	A	A	C	C	A	C	C
Phthalic Acid	C	C	C	C	NS	C	A	A	A	A	A	A	A	A	A	A
Phthalic Anhydride	NS	NS	NS	NS	NS	NS	A	A	A	A	A	A	A	A	A	A
Polyacrylonitrile	A	A	A	A	A	A	A	A	A	A	A	A	A	-	-	-
Polyvinyl Acetate	A	A	A	A	NS	C	-	-	-	-	A	A	-	-	-	-
Potash	A	A	A	A	A	A	A	A	A	A	A	A	A	A	A	A
Potassium Chloride	A	A	A	A	A	A	A	A	A	A	A	A	A	A	A	A
Potassium Dichromate	A	A	A	A	C	C	A	A	A	A	A	A	A	A	A	A
Potassium Hydroxide	A	A	A	A	NS	NS	A	A	A	A	A	A	A	A	A	A
Potassium Nitrate	A	A	A	A	A	A	A	A	C	A	A	A	A	A	A	A
Potassium Sulfate	A	A	A	A	A	A	A	A	A	A	A	A	A	-	-	-
Potassium Sulfide	A	A	A	A	A	A	-	-	-	-	-	-	-	-	-	-
Potassium Sulfite	A	A	A	A	A	A	-	-	-	-	-	-	-	-	-	-
Propane	A	A	A	A	NS	C	A	A	A	A	A	A	A	A	A	A
Propylene	NS	NS	NS	NS	NS	NS	A	A	A	A	A	A	A	A	A	A
Propyl Alcohol	A	A	A	A	A	A	A	A	A	A	A	A	-	-	-	-
Propylene Glycol	A	A	A	A	A	A	A	A	A	A	A	A	-	-	-	-
Pydrauls, Skydrols	NS	NS	NS	NS	NS	NS	A	A	A	A	C	C	C	-	-	-
Pyridine	NS	NS	NS	NS	NS	NS	A	A	A	A	A	A	A	C	C	C
Red Sulfite Liquor	NS	NS	NS	NS	NS	NS	A	A	A	A	C	C	C	-	-	-
Red Sulfite Liquor (>380°F)	NS	NS	NS	NS	NS	NS	C	C	C	C	A	NS	NS	-	-	-
Refrigerant R-11 **	A	A	A	A	NS	NS	A	A	A	A	A	A	A	-	-	-
Refrigerant R-12 **	A	A	A	A	C	A	A	A	A	A	A	C	C	-	-	-
Refrigerant R-22 **	C	C	C	C	C	A	A	A	A	A	A	A	A	-	-	-
Refrigerant R-113 **	A	A	A	A	C	A	A	A	A	A	C	C	C	-	-	-
Refrigerant HCFC 123 **	C	NS	C	C	NS	C	A	A	A	A	-	-	-	-	-	-
Refrigerant HCFC 124 *	C	NS	C	C	NS	A	A	A	A	A	-	-	-	-	-	-

Chemical Resistance - Non-Metallic Gaskets

The following information is a general guide only for the selection of a suitable gasket material as there are unlimited combinations of fluid, pressure, and temperature conditions.

A = Acceptable C = Caution-Dependent on Conditions NS = Not Suitable - = No Data Available

Fluid	Durlon® Compressed Non-Asbestos Sheet						Durlon® PTFE				Durlon® Flexible Graphite			Durlon® HT1000®		
	5000 7900 7910 7925 7950	8300 8900	8400	8500	8600	8700	9000 9000N 9002	9200	9400	Virgin Joint Sealant 9600	FGS95	CFG FGL316 FGM316	FGT316	S90	L316	T316
Refrigerant HFC 125 *	C	C	C	C	NS	A	A	A	A	A	-	-	-	-	-	-
Refrigerant HFC 134a *	A	A	A	A	C	A	A	A	A	A	-	-	-	-	-	-
Refrigerant HCFC 141b	A	A	A	A	NS	A	A	A	A	A	-	-	-	-	-	-
Refrigerant HFC 236fa	A	A	A	A	NS	A	A	A	A	A	-	-	-	-	-	-
Refrigerant Blend HP 62*	A	A	A	A	NS	A	A	A	A	A	-	-	-	-	-	-
Refrigerant Blend HP 80	C	C	C	C	NS	A	A	A	A	A	-	-	-	-	-	-
Refrigerant Blend HP 81	C	C	C	C	NS	A	A	A	A	A	-	-	-	-	-	-
Refrigerant Blend 404a*	A	A	A	A	NS	A	A	A	A	A	-	-	-	-	-	-
Salicylic Acid	A	A	A	A	A	C	-	-	-	-	-	-	-	A	-	-
Sea Water	A	A	A	A	A	A	A	A	A	A	A	NS	NS	A	NS	NS
Silicone Oil	A	A	A	A	A	A	A	A	-	-	A	A	-	A	-	-
Siler Chloride	A	A	A	A	A	A	-	-	-	-	-	-	-	-	-	-
Silver Nitrate	A	A	A	A	A	A	A	A	A	A	A	A	A	-	-	-
Soap Solutions	A	A	A	A	A	A	A	A	C	A	A	A	A	A	A	A
Soda Ash	A	A	A	A	A	A	A	A	A	A	A	A	A	A	A	A
Sodium Bicarbonate	A	A	A	A	A	A	A	A	A	A	A	A	A	A	A	A
Sodium Bisulfate	A	A	A	A	C	A	-	-	-	-	A	A	A	-	-	-
Sodium Bisulfite	A	A	A	A	C	A	A	A	A	A	A	A	A	A	A	A
Sodium Carbonate	A	A	A	A	A	A	A	A	A	A	A	A	A	A	A	A
Sodium Chloride	A	A	A	A	A	A	A	A	A	A	A	A	A	A	A	A
Sodium Hydroxide	C	C	A	C	C	NS	A	A	A	A	A	C	C	A	A	A
Sodium Hydroxide (<10%)	A	A	A	A	C	A	A	A	A	A	A	-	-	-	-	-
Sodium Hydroxide (10-50%)	NS	NS	C	NS	NS	NS	C	A	A	A	A	-	-	-	-	-
Sodium Hypochlorite	NS	NS	NS	NS	C	C	A	A	C	A	C	NS	NS	-	-	-
Sodium Nitrate	A	A	A	A	C	C	A	A	A	A	-	-	-	-	-	-
Sodium Phosphate	A	A	A	A	A	A	A	A	A	A	A	A	A	-	-	-
Sodium Silicate	A	A	A	A	A	A	A	A	A	A	A	C	C	A	C	C
Sodium Sulfate	A	A	A	A	A	A	A	A	A	A	A	A	A	A	A	A
Sodium Sulfite	A	A	A	A	A	A	-	-	-	-	-	-	-	-	-	-
Sour Crude Oil	A	A	A	A	NS	C	A	A	A	A	A	A	A	A	A	A
Soybean Oil	A	A	A	A	NS	C	A	A	A	A	A	A	A	A	A	A
Steam (to 450°F)	A	A	A	A	A	A	A	A	A	A	A	A	A	A	A	A
Steam (over 450°F)	A	A	A	A	C	C	NS	NS	NS	NS	A	A	A	A	A	A
Steam (Low-med Pressure)	A	A	A	A	A	C	A	A	A	A	A	A	A	-	-	-
Steam (High Pressure)	NS	A	A	A	C	NS	-	-	-	-	A	A	A	-	-	-
Stearic Acid	A	A	A	A	C	A	A	A	A	A	A	A	A	A	A	A
Stoddard Solvent	A	A	A	A	NS	C	A	A	A	A	A	A	A	-	-	-
Styrene	NS	NS	NS	NS	NS	NS	A	A	A	A	A	A	A	-	-	-
Sulfite Liquors	C	C	A	C	C	C	A	A	A	A	A	C	C	-	-	-
Sulfur	NS	NS	NS	NS	NS	C	A	A	-	-	A	-	-	-	-	-
Sulfur (Molten)	C	C	C	C	NS	C	A	A	A	A	A	A	A	A	A	A
Sulfur Dioxide	NS	NS	C	NS	NS	NS	A	A	A	A	A	A	A	A	A	A
Sulfuric Acid (20%)	NS	NS	NS	NS	NS	NS	A	A	A	A	NS	NS	NS	NS	NS	NS
Sulfuric Acid (<50%)	NS	NS	NS	NS	NS	NS	A	A	NS	A	-	-	-	NS	NS	NS
Sulfuric Acid (60%)	NS	NS	NS	NS	NS	NS	A	A	NS	A	-	-	-	NS	NS	NS
Sulfuric Acid (70%)	NS	NS	NS	NS	NS	NS	A	C	NS	A	-	-	-	NS	NS	NS
Sulfuric Acid (>80%)	NS	NS	NS	NS	NS	NS	C	NS	NS	A	-	-	-	NS	NS	NS
Sulfuric Acid, Conc	NS	NS	NS	NS	NS	NS	A	C	A	A	NS	NS	NS	NS	NS	NS

Chemical Resistance - Non-Metallic Gaskets

The following information is a general guide only for the selection of a suitable gasket material as there are unlimited combinations of fluid, pressure, and temperature conditions.

A = Acceptable C = Caution-Dependent on Conditions NS = Not Suitable - = No Data Available

Fluid	Durlon® Compressed Non-Asbestos Sheet						Durlon® PTFE				Durlon® Flexible Graphite			Durlon® HT1000®		
	5000 7900 7910 7925 7950	8300 8900	8400	8500	8600	8700	9000 9000N 9002	9200	9400	Virgin Joint Sealant 9600	FGS95	CFG FGL316 FGM316	FGT316	S90	L316	T316
Sulfuric Acid, Conc (>200°F)	NS	NS	NS	NS	NS	NS	A	NS	NS	A	NS	NS	NS	NS	NS	NS
Fuming Sulfuric Acid, Oleum	NS	NS	NS	NS	NS	NS	A	NS	NS	A	NS	NS	NS	-	-	-
Tar	A	A	A	A	C	C	A	A	A	A	A	A	A	A	A	A
Tartaric Acid	A	A	A	A	A	A	A	A	A	A	A	A	A	A	A	A
Tetrachloroethane	C	C	C	C	NS	NS	A	A	A	A	A	A	A	C	C	C
Tetrahydrofuran (THF)	NS	NS	NS	NS	NS	NS	A	A	A	A	A	A	A	-	-	-
Toluene	NS	NS	NS	NS	NS	C	A	A	A	A	A	A	A	A	A	A
Transformer Oil	A	A	A	A	NS	C	A	A	A	A	A	A	A	A	A	A
Transmission Fluid	A	A	A	A	NS	C	A	A	A	A	A	A	A	A	A	A
Trichloroethane	NS	NS	NS	NS	NS	NS	A	A	A	A	A	A	A	C	C	C
Trichloroethylene	C	C	C	C	NS	NS	A	A	A	A	A	A	A	C	C	C
Triethanolamine	C	C	C	C	C	A	A	A	A	A	C	C	C	A	C	C
Turpentine	A	A	A	A	NS	C	A	A	A	A	A	A	A	A	A	A
Urea	A	A	A	A	A	A	A	A	A	A	A	A	A	A	A	A
Varsol	A	A	A	A	NS	NS	A	A	A	A	A	A	A	A	A	A
Vegetable Oil	A	A	A	A	NS	C	A	A	A	A	A	A	A	A	A	A
Vinegar	A	A	A	A	C	A	A	A	A	A	A	A	A	A	A	A
Vinyl Acetate	C	C	C	C	NS	C	A	A	A	A	A	A	A	A	A	A
Vinyl Chloride	NS	NS	NS	NS	NS	NS	A	A	A	A	A	A	A	-	-	-
Water	A	A	A	A	A	A	A	A	A	A	A	A	A	A	A	A
Water Mine Acid	C	C	C	C	C	C	A	A	-	A	-	-	-	-	-	-
Water Deionized	A	A	A	A	A	A	A	A	A	A	-	-	-	-	-	-
Water, Sea	A	A	A	A	A	A	A	A	A	A	A	A	A	A	A	A
Whiskey	A	A	A	A	A	A	A	A	A	A	A	A	A	A	A	A
White Sulfate Liquor	A	A	A	A	A	A	A	A	A	A	A	A	A	A	A	A
White Spirit	A	A	A	A	C	C	A	A	A	A	A	A	A	-	-	-
Wines	A	A	A	A	A	A	A	A	A	A	A	A	A	A	A	A
Xylene	NS	NS	NS	NS	NS	NS	A	A	A	A	A	A	A	A	A	A
Zinc Chloride	A	A	A	A	A	A	A	A	A	A	A	A	A	-	-	-
Zinc Nitrate	A	A	A	A	A	A	A	A	C	A	C	C	C	-	-	-
Zinc Sulfate	A	A	A	A	A	A	A	A	A	A	A	A	A	-	-	-

The information provided in the Chemical Resistant Charts (pages 67-74) is a general guide for the selection of a suitable gasket material. The substances listed are evaluated for their effect on the gasket materials at ambient temperature -40°F/C to 38°C (100°F) unless stated otherwise. For unusual conditions of fluid concentrates, internal pressures or temperature consult our technical support team. This evaluation is based on experience and laboratory or field tests. No guarantee can be given as to the actual performance experienced by the end user. There are several fluids used in food which can be sealed by SBR, however due to flavor pickup, we have marked these products "Caution." These chemical resistance charts supersede and obsolete all previously issued charts.

* With mineral oil

** With polyolester oil

*** Durlon® styles 9002 & 9200 have BAM approval and should be cleaned & packaged for oxygen service prior to installation.

Gasket Dimensions ASME B16.21 - Cut Gaskets & CFG's

CLASS 150#													
B16.5 (Inches)		Ring	Full Face				B16.5 (mm)		Ring	Full Face			
Pipe Size	Gasket I.D.	Gasket O.D.	Gasket O.D.	Bolt Circle	Bolt Hole Qty.	Bolt Hole Dia.	Pipe Size DN (mm)	Gasket I.D.	Gasket O.D.	Gasket O.D.	Bolt Circle	Bolt Hole Qty.	Bolt Hole Dia.
0.5	0.84	1.88	3.50	2.38	4	0.63	15	21.3	47.8	88.9	60.5	4	16.0
0.75	1.06	2.25	3.88	2.75	4	0.63	20	26.9	57.2	98.6	69.9	4	16.0
1	1.31	2.62	4.25	3.13	4	0.63	25	33.3	66.5	108.0	79.5	4	16.0
1.25	1.66	3.00	4.63	3.50	4	0.63	32	42.2	76.2	117.6	88.9	4	16.0
1.5	1.91	3.38	5.00	3.88	4	0.63	40	48.5	85.9	127.0	98.6	4	16.0
2	2.38	4.12	6.00	4.75	4	0.75	50	60.5	104.6	152.4	120.7	4	19.1
2.5	2.88	4.88	7.00	5.50	4	0.75	65	73.2	124.0	177.8	139.7	4	19.1
3	3.50	5.38	7.50	6.00	4	0.75	80	88.9	136.7	190.5	152.4	4	19.1
3.5	4.00	6.38	8.50	7.00	8	0.75	90	101.6	162.1	215.9	177.8	8	19.1
4	4.50	6.88	9.00	7.50	8	0.75	100	114.3	174.8	228.6	190.5	8	19.1
5	5.56	7.75	10.00	8.50	8	0.88	125	141.2	196.9	254.0	215.9	8	22.4
6	6.62	8.75	11.00	9.50	8	0.88	150	168.1	222.3	279.4	241.3	8	22.4
8	8.62	11.00	13.50	11.75	8	0.88	200	218.9	279.4	342.9	298.5	8	22.4
10	10.75	13.38	16.00	14.25	12	1.00	250	273.1	339.9	406.4	362.0	12	25.4
12	12.75	16.13	19.00	17.00	12	1.00	300	323.9	409.7	482.6	431.8	12	25.4
14	14.00	17.75	21.00	18.75	12	1.13	350	355.6	450.9	533.4	476.3	12	28.7
16	16.00	20.25	23.50	21.25	16	1.13	400	406.4	514.4	596.9	539.8	16	28.7
18	18.00	21.62	25.00	22.75	16	1.25	450	457.2	549.1	635.0	577.9	16	31.8
20	20.00	23.88	27.50	25.00	20	1.25	500	508.0	606.6	698.5	635.0	20	31.8
24	24.00	28.25	32.00	29.50	20	1.38	600	609.6	717.6	812.8	749.3	20	35.1

CLASS 300#													
B16.5 (Inches)		Ring	Full Face				B16.5 (mm)		Ring	Full Face			
Pipe Size	Gasket I.D.	Gasket O.D.	Gasket O.D.	Bolt Circle	Bolt Hole Qty.	Bolt Hole Dia.	Pipe Size DN (mm)	Gasket I.D.	Gasket O.D.	Gasket O.D.	Bolt Circle	Bolt Hole Qty.	Bolt Hole Dia.
0.5	0.84	2.12	3.75	2.62	4	0.63	15	21.3	53.8	95.3	66.5	4	16.0
0.75	1.06	2.62	4.62	3.25	4	0.75	20	26.9	66.5	117.3	82.6	4	19.1
1	1.31	2.88	4.88	3.50	4	0.75	25	33.3	73.2	124.0	88.9	4	19.1
1.25	1.66	3.25	5.25	3.88	4	0.75	32	42.2	82.6	133.4	98.6	4	19.1
1.5	1.91	3.75	6.12	4.50	4	0.88	40	48.5	95.3	155.4	114.3	4	22.4
2	2.38	4.38	6.50	5.00	8	0.75	50	60.5	111.3	165.1	127.0	4	19.1
2.5	2.88	5.12	7.50	5.88	8	0.88	65	73.2	130.0	190.5	149.4	4	22.4
3	3.50	5.88	8.25	6.62	8	0.88	80	88.9	149.4	209.6	168.1	4	22.4
3.5	4.00	6.50	9.00	7.25	8	0.88	90	101.6	165.1	228.6	184.2	8	22.4
4	4.50	7.12	10.00	7.88	8	0.88	100	114.3	180.8	254.0	200.2	8	22.4
5	5.56	8.50	11.00	9.25	8	0.88	125	141.2	215.9	279.4	235.0	8	22.4
6	6.62	9.88	12.50	10.62	12	0.88	150	168.1	251.0	317.5	269.7	8	22.4
8	8.62	12.12	15.00	13.00	12	1.00	200	218.9	307.8	381.0	330.2	8	25.4
10	10.75	14.25	17.50	15.25	16	1.12	250	273.1	362.0	444.5	387.4	12	28.4
12	12.75	16.62	20.50	17.75	16	1.25	300	323.9	422.1	520.7	450.9	12	31.8
14	14.00	19.12	23.00	20.25	20	1.25	350	355.6	485.6	584.2	514.4	12	31.8
16	16.00	21.25	25.50	22.50	20	1.38	400	406.4	539.8	647.7	571.5	16	35.1
18	18.00	23.50	28.00	24.75	24	1.38	450	457.2	596.9	711.2	628.7	16	35.1
20	20.00	25.75	30.50	27.00	24	1.38	500	508.0	654.1	774.7	685.8	20	35.1
24	24.00	30.50	36.00	32.00	24	1.62	600	609.6	774.7	914.4	812.8	20	41.1

Gasket Dimensions - Durtec® - Units in inches (millimeters)

NPS	DN	I.D.	Centering Ring O.D.						1500	2500
			Pressure Class							
			150	300	400	600	900	1500		
1/2"	15	0.91 (23.1)	1.88 (47.8)	2.13 (54.1)	2.13 (54.1)	2.13 (54.1)	2.50 (63.5)	2.50 (63.5)	2.75 (69.9)	
3/4"	20	1.13 (28.7)	2.25 (57.2)	2.63 (66.8)	2.63 (66.8)	2.63 (66.8)	2.75 (69.9)	2.75 (69.9)	3.00 (76.2)	
1"	25	1.44 (36.6)	2.63 (66.8)	2.88 (73.2)	2.88 (73.2)	2.88 (73.2)	3.13 (79.5)	3.13 (79.5)	3.38 (85.9)	
1-1/4"	32	1.75 (44.5)	3.00 (76.2)	3.25 (82.6)	3.25 (82.6)	3.25 (82.6)	3.50 (88.9)	3.50 (88.9)	4.13 (104.9)	
1-1/2"	40	2.06 (52.3)	3.38 (85.9)	3.75 (95.3)	3.75 (95.3)	3.75 (95.3)	3.88 (98.6)	3.88 (98.6)	4.63 (117.6)	
2"	50	2.75 (69.9)	4.13 (104.9)	4.38 (111.1)	4.38 (111.3)	4.38 (111.3)	5.63 (143.0)	5.63 (143.0)	5.75 (146.1)	
2-1/2"	65	3.25 (82.6)	4.88 (124.0)	5.13 (130.3)	5.13 (130.3)	5.13 (130.3)	6.50 (165.1)	6.50 (165.1)	6.63 (168.4)	
3"	80	3.87 (98.3)	5.38 (136.7)	5.88 (149.4)	5.88 (149.4)	5.88 (149.4)	6.63 (168.4)	6.88 (174.8)	7.75 (196.9)	
3-1/2"	90	4.37 (111.0)	6.37 (161.9)	6.50 (165.1)	6.37 (161.9)	6.37 (161.9)	7.50 (190.5)	7.38 (187.5)	-	
4"	100	4.87 (123.7)	6.88 (174.8)	7.13 (181.0)	7.00 (177.8)	7.63 (193.8)	8.13 (206.5)	8.25 (209.6)	9.25 (235.0)	
5"	125	5.94 (150.9)	7.75 (196.9)	8.50 (215.9)	8.38 (212.9)	9.50 (241.3)	9.75 (247.7)	10.00 (254.0)	11.00 (279.4)	
6"	150	7.00 (177.8)	8.75 (222.3)	9.88 (251.0)	9.75 (247.7)	10.50 (266.7)	11.38 (289.1)	11.13 (282.7)	12.50 (317.5)	
8"	200	9.00 (228.6)	11.00 (279.4)	12.13 (308.1)	12.00 (304.8)	12.63 (320.8)	14.13 (358.9)	13.88 (352.6)	15.25 (387.4)	
10"	250	11.13 (282.7)	13.38 (339.9)	14.25 (362.0)	14.13 (358.9)	15.75 (400.1)	17.13 (435.1)	17.13 (435.1)	18.75 (476.3)	
12"	300	13.37 (339.6)	16.13 (409.7)	16.63 (422.4)	16.5 (419.1)	18.00 (457.2)	19.63 (498.6)	20.50 (520.7)	21.63 (549.4)	
14"	350	14.63 (371.6)	17.75 (450.9)	19.13 (485.9)	19.00 (482.6)	19.38 (492.3)	20.50 (520.7)	22.75 (577.9)	-	
16"	400	16.63 (422.4)	20.25 (514.4)	21.25 (539.8)	21.13 (536.7)	22.25 (565.2)	22.63 (574.8)	25.25 (641.4)	-	
18"	450	18.87 (479.3)	21.63 (549.4)	23.50 (596.9)	23.38 (593.9)	24.13 (612.9)	25.13 (638.3)	27.75 (704.9)	-	
20"	500	20.87 (530.1)	23.88 (606.6)	25.75 (654.1)	25.50 (647.7)	26.88 (682.8)	27.50 (698.5)	29.75 (755.7)	-	
24"	600	24.87 (631.7)	28.25 (717.6)	30.50 (774.7)	30.25 (768.4)	31.13 (790.7)	33.00 (838.2)	35.50 (901.7)	-	

Gasket Dimensions - Spiral Wound Gaskets - Units in inches

Flange Size (NPS)	Windings OD		Durlon® SWG Style By Pressure Class*														Durlon® SWG Style DRI By Pressure Class**							
	Class 150, 300, 400, 600	Class 900, 1500, 2500	150		300		400		600		900		1500		2500		150	300	400	600	900	1500	2500	
			ID	OD	ID	OD	ID	OD	ID	OD	ID	OD	ID	OD	ID	OD	ID	ID	ID	ID	ID	ID	ID	ID
1/2"	1.25	1.25	0.75	1.88	0.75	2.13	-	-	0.75	2.13	-	-	0.75	2.50	0.75	2.75	0.56	0.56	-	0.56	-	0.56	0.56	
3/4"	1.56	1.56	1.00	2.25	1.00	2.63	-	-	1.00	2.63	-	-	1.00	2.75	1.00	3.00	0.81	0.81	-	0.81	-	0.81	0.81	
1"	1.88	1.88	1.25	2.63	1.25	2.88	-	-	1.25	2.88	-	-	1.25	3.13	1.25	3.38	1.06	1.06	-	1.06	-	1.06	1.06	
1-1/4"	2.38	2.38	1.88	3.00	1.88	3.25	-	-	1.88	3.25	-	-	1.56	3.50	1.56	4.13	1.50	1.50	-	1.50	-	1.31	1.31	
1-1/2"	2.75	2.75	2.13	3.38	2.13	3.75	-	-	2.13	3.75	-	-	1.88	3.88	1.88	4.63	1.75	1.75	-	1.75	-	1.63	1.63	
2"	3.38	3.38	2.75	4.13	2.75	4.38	-	-	2.75	4.38	-	-	2.31	5.63	2.31	5.75	2.19	2.19	-	2.19	-	2.06	2.06	
2-1/2"	3.88	3.88	3.25	4.88	3.25	5.13	-	-	3.25	5.13	-	-	2.75	6.50	2.75	6.63	2.62	2.62	-	2.62	-	2.50	2.50	
3"	4.75	4.75	4.00	5.38	4.00	5.88	-	-	4.00	5.88	3.75	6.63	3.63	6.88	3.63	7.75	3.19	3.19	-	3.19	3.10	3.10	3.10	
3-1/2"	5.25	-	4.50	6.38	4.50	6.50	-	-	4.13	6.38	-	-	-	-	-	-	3.98	3.98	-	3.60	-	-	-	
4"	5.88	5.88	5.00	6.88	5.00	7.13	4.75	7.00	4.75	7.63	4.75	8.13	4.63	8.25	4.63	9.25	4.19	4.19	4.04	4.04	4.04	3.85	3.85	
5"	7.00	7.00	6.13	7.75	6.13	8.50	5.81	8.38	5.81	9.50	5.81	9.75	5.63	10.00	5.63	11.00	5.19	5.19	5.05	5.05	5.05	4.90	4.90	
6"	8.25	8.25	7.19	8.75	7.19	9.88	6.88	9.75	6.88	10.50	6.88	11.38	6.75	11.13	6.75	12.50	6.19	6.19	6.10	6.10	6.10	5.80	5.80	
8"	10.38	10.13	9.19	11.00	9.19	12.13	8.88	12.00	8.88	12.63	8.75	14.13	8.50	13.88	8.50	15.25	8.50	8.50	8.10	8.10	7.75	7.75	7.75	
10"	12.50	12.25	11.31	13.38	11.31	14.25	10.81	14.13	10.81	15.75	10.88	17.13	10.50	17.13	10.63	18.75	10.56	10.56	10.05	10.05	9.69	9.69	9.69	
12"	14.75	14.50	13.38	16.13	13.38	16.63	12.88	16.50	12.88	18.00	12.75	19.63	12.75	20.50	12.50	21.63	12.50	12.50	12.10	12.10	11.50	11.50	11.50	
14"	16.00	15.75	14.63	17.75	14.63	19.13	14.25	19.00	14.25	19.38	14.00	20.50	14.25	22.75	-	-	13.75	13.75	13.50	13.50	12.63	12.63	-	
16"	18.25	18.00	16.63	20.25	16.63	21.25	16.25	21.13	16.25	22.25	16.25	22.63	16.00	25.25	-	-	15.75	15.75	15.35	15.35	14.75	14.50	-	
18"	20.75	20.50	18.69	21.63	18.69	23.50	18.50	23.38	18.50	24.13	18.25	25.13	18.25	27.75	-	-	17.69	17.69	17.25	17.25	16.75	16.75	-	
20"	22.75	22.50	20.69	23.88	20.69	25.75	20.50	25.50	20.50	26.88	20.50	27.50	20.25	29.75	-	-	19.69	19.69	19.25	19.25	19.00	18.75	-	
24"	27.00	26.75	24.75	28.25	24.75	30.50	24.75	30.25	24.75	31.13	24.75	33.00	24.25	35.50	-	-	23.75	23.75	23.25	23.25	23.25	22.75	-	

* Windings ID/Outer Ring OD ** Inner Ring ID

Notes:

1. Inner rings (style DRI) are required for all PTFE filled gaskets; for "all other" filler materials NPS 24" Class 900 gaskets, NPS 12" - 24" Class 1500 gaskets, and NPS 4" - 12" Class 2500 gaskets (see shaded areas on chart ).
2. The dimensions for Class 300, Class 400, & Class 600 gaskets in NPS 1/2" - 3" sizes are the same and are designated as dual Class 300/400/600 in these sizes and shall be marked accordingly.
3. The dimensions for Class 900 & 1500 gaskets in NPS 1/2" - 2 1/2" are the same and are designated as dual Class 900/1500 in these sizes and shall be marked accordingly.
4. Where there are no sizes listed for Class 400 flanges in NPS 1/2 through NPS 1 1/2 (use Class 600); Class 900 flanges in NPS 1/2 through NPS 2 1/2 (use Class 1500).
5. There are no flanges in NPS 3 1/2 Class 900 and Class 1500; or Class 2500 flanges in NPS 3 1/2 or NPS 14 and larger.
6. Inner rings (style DRI) are the default selling condition for graphite filled gaskets. If inner rings are not required, "no inner ring" (style DR) must be specified for graphite or mica-graphite filled gaskets at time of order. Adapted from ASME B16.20.
7. Adapted from B16.20.

Gasket Dimensions - Spiral Wound Gaskets - Units in millimeters

Flange Size (NPS)	Windings OD		Durlon® SWG Style By Pressure Class*												Durlon® SWG Style DRI By Pressure Class**								
	Class 150, 300, 400, 600	Class 900, 1500, 2500	150		300		400		600		900		1500		2500		150	300	400	600	900	1500	2500
			ID	OD	ID	OD	ID	OD	ID	OD	ID	OD	ID	OD	ID	OD	ID	ID	ID	ID	ID	ID	ID
1/2"	31.80	31.80	19.10	47.80	19.10	54.10	-	-	19.10	54.10	-	-	19.10	63.50	19.10	69.90	14.20	14.20	-	14.20	-	14.20	14.20
3/4"	39.60	39.60	25.40	57.20	25.40	66.80	-	-	25.40	66.80	-	-	25.40	69.90	25.40	76.20	20.60	20.60	-	20.60	-	20.60	20.60
1"	47.80	47.80	31.80	66.80	31.80	73.20	-	-	31.80	73.20	-	-	31.80	79.50	31.80	85.90	26.90	26.90	-	26.90	-	26.90	26.90
1-1/4"	60.50	60.50	47.80	76.20	47.80	82.60	-	-	47.80	82.60	-	-	39.60	88.90	39.60	104.90	38.10	38.10	-	38.10	-	33.30	33.30
1-1/2"	69.90	69.90	54.10	85.90	54.10	95.30	-	-	54.10	95.30	-	-	47.80	98.60	47.80	117.60	44.50	44.50	-	44.50	-	41.40	41.40
2"	85.90	85.90	69.90	104.90	69.90	111.30	-	-	69.90	111.30	-	-	58.70	143.00	58.70	146.10	55.60	55.60	-	55.60	-	52.30	52.30
2-1/2"	98.60	98.60	82.60	124.00	82.60	130.30	-	-	82.60	130.30	-	-	69.90	165.10	69.90	168.40	66.50	66.50	-	66.50	-	63.50	63.50
3"	120.70	120.70	101.60	136.70	101.60	149.40	-	-	101.60	149.40	95.30	168.40	92.20	174.80	92.20	196.90	81.00	81.00	-	81.00	78.70	78.70	78.70
3-1/2"	133.40	-	114.30	161.90	114.30	165.10	-	-	104.80	161.90	-	-	-	-	-	-	66.50	66.50	-	91.40	-	-	-
4"	149.40	149.40	127.00	174.80	127.00	181.10	120.70	177.80	120.70	193.80	120.70	206.50	117.60	209.60	117.60	235.00	106.40	106.40	102.60	102.60	102.60	97.80	97.80
5"	177.80	177.80	155.70	196.90	155.70	215.90	147.60	212.90	147.60	241.30	147.60	247.70	143.00	254.00	143.00	279.40	131.80	131.80	128.30	128.30	128.30	124.50	124.50
6"	209.60	209.60	182.60	222.30	182.60	251.00	174.80	247.70	174.80	266.70	174.80	289.10	171.50	282.70	171.50	317.50	157.20	157.20	154.90	154.90	154.90	147.30	147.30
8"	263.70	257.30	233.40	279.40	233.40	308.10	225.60	304.80	225.60	320.80	222.30	358.90	215.90	352.60	215.90	387.40	215.90	215.90	205.70	205.70	196.90	196.90	196.90
10"	317.50	311.20	287.30	339.90	287.30	362.00	274.60	358.90	274.60	400.10	276.40	435.10	266.7	435.10	270.00	476.30	268.20	268.20	255.30	255.30	246.10	246.10	246.10
12"	374.70	368.30	339.90	409.70	339.90	422.40	327.20	419.10	327.20	457.20	323.90	498.60	323.90	520.70	317.50	549.40	317.50	317.50	307.30	307.30	292.10	292.10	292.10
14"	406.40	400.10	371.60	450.90	371.60	485.90	362.00	482.60	362.00	492.30	355.60	520.70	362.00	577.90	-	-	349.30	349.30	342.90	342.90	320.80	320.80	-
16"	463.60	457.20	422.40	514.40	422.40	539.80	412.80	536.70	412.80	565.20	412.80	574.80	406.40	641.40	-	-	400.10	400.10	389.90	389.90	374.70	368.30	-
18"	527.10	520.70	474.70	549.40	474.70	596.90	469.90	593.90	469.90	612.90	463.60	638.30	463.60	704.90	-	-	449.30	449.30	438.20	438.20	425.50	425.50	-
20"	577.90	571.50	525.50	606.60	525.50	654.10	520.70	647.70	520.70	682.80	520.7	698.50	514.40	755.70	-	-	500.10	500.10	489.00	489.00	482.60	476.30	-
24"	685.80	679.50	628.70	717.60	628.70	774.70	628.70	768.40	628.70	790.70	628.70	838.20	616.00	901.70	-	-	603.30	603.30	590.60	590.60	590.60	577.90	-

* Windings ID/Outer Ring OD ** Inner Ring ID

Notes:

1. Inner rings (style DRI) are required for all PTFE filled gaskets; for "all other" filler materials NPS 24" Class 900 gaskets, NPS 12" - 24" Class 1500 gaskets, and NPS 4" - 12" Class 2500 gaskets (see shaded areas on chart).
2. The dimensions for Class 300, Class 400, & Class 600 gaskets in NPS 1/2" - 3" sizes are the same and are designated as dual Class 300/400/600 in these sizes and shall be marked accordingly.
3. The dimensions for Class 900 & 1500 gaskets in NPS 1/2" - 2 1/2" are the same and are designated as dual Class 900/1500 in these sizes and shall be marked accordingly.
4. Where there are no sizes listed for Class 400 flanges in NPS 1/2 through NPS 1 1/2 (use Class 600); Class 900 flanges in NPS 1/2 through NPS 2 1/2 (use Class 1500).
5. There are no flanges in NPS 3 1/2 Class 900 and Class 1500; or Class 2500 flanges in NPS 3 1/2 or NPS 14 and larger.
6. Inner rings (style DRI) are the default selling condition for graphite filled gaskets. If inner rings are not required, "no inner ring" (style DR) must be specified for graphite or mica-graphite filled gaskets at time of order. Adapted from ASME B16.20.
7. Adapted from B16.20.

Gasket Dimensions - Kammprofile - Units in inches (millimeters)

NPS	DN	Serrated Metal Ring (mm)		Centering Ring Outside Diameter						
		ASME, BS & MSS		Pressure Class						
		ID	OD	150	300	400	600	900	1500	2500
1/2"	15	0.91 (23.1)	1.31 (33.3)	1.88 (47.8)	2.13 (54.1)	-	2.13 (54.1)	-	2.50 (63.5)	2.75 (69.9)
3/4"	20	1.13 (28.7)	1.56 (39.6)	2.25 (57.2)	2.63 (66.8)	-	2.63 (66.8)	-	2.75 (69.9)	3.00 (76.2)
1"	25	1.44 (36.6)	1.87 (47.5)	2.63 (66.8)	2.88 (73.2)	-	2.88 (73.2)	-	3.13 (79.5)	3.38 (85.9)
1-1/4"	32	1.75 (44.5)	2.37 (60.2)	3.00 (76.2)	3.25 (82.6)	-	3.25 (82.6)	-	3.50 (88.9)	4.13 (104.9)
1-1/2"	40	2.06 (52.3)	2.75 (69.9)	3.38 (85.9)	3.75 (95.3)	-	3.75 (95.3)	-	3.88 (98.6)	4.63 (117.6)
2"	50	2.75 (69.9)	3.50 (88.9)	4.13 (104.9)	4.38 (111.1)	-	4.38 (111.3)	-	5.63 (143.0)	5.75 (146.1)
2-1/2"	65	3.25 (82.6)	4.00 (101.6)	4.88 (124.0)	5.13 (130.3)	-	5.13 (130.3)	-	6.50 (165.1)	6.63 (168.4)
3"	80	3.87 (98.3)	4.87 (123.7)	5.38 (136.7)	5.88 (149.4)	-	5.88 (149.4)	6.63 (168.4)	6.88 (174.8)	7.75 (196.9)
3-1/2"	90	4.37 (111.0)	5.37 (136.5)	6.37 (161.9)	6.50 (165.1)	-	6.37 (161.9)	-	-	-
4"	100	4.87 (123.7)	6.06 (153.9)	6.88 (174.8)	7.13 (181.0)	7.00 (177.8)	7.63 (193.8)	8.13 (206.5)	8.25 (209.6)	9.25 (235.0)
5"	125	5.94 (150.9)	7.19 (182.6)	7.75 (196.9)	8.50 (215.9)	8.38 (212.9)	9.50 (241.3)	9.75 (247.7)	10.00 (254.0)	11.00 (279.4)
6"	150	7.00 (177.8)	8.37 (212.6)	8.75 (222.3)	9.88 (251.0)	9.75 (247.7)	10.50 (266.7)	11.38 (289.1)	11.13 (282.7)	12.50 (317.5)
8"	200	9.00 (228.6)	10.50 (266.7)	11.00 (279.4)	12.13 (308.1)	12.00 (304.8)	12.63 (320.8)	14.13 (358.9)	13.88 (352.6)	15.25 (387.4)
10"	250	11.13 (282.7)	12.63 (320.8)	13.38 (339.9)	14.25 (362.0)	14.13 (358.9)	15.75 (400.1)	17.13 (435.1)	17.13 (435.1)	18.75 (476.3)
12"	300	13.37 (339.6)	14.87 (377.7)	16.13 (409.7)	16.63 (422.4)	16.5 (419.1)	18.00 (457.2)	19.63 (498.6)	20.50 (520.7)	21.63 (549.4)
14"	350	14.63 (371.6)	16.13 (409.7)	17.75 (450.9)	19.13 (485.9)	19.00 (482.6)	19.38 (492.3)	20.50 (520.7)	22.75 (577.9)	-
16"	400	16.63 (422.4)	18.37 (466.6)	20.25 (514.4)	21.25 (539.8)	21.13 (536.7)	22.25 (565.2)	22.63 (574.8)	25.25 (641.4)	-
18"	450	18.87 (479.3)	20.87 (530.1)	21.63 (549.4)	23.50 (596.9)	23.38 (593.9)	24.13 (612.9)	25.13 (638.3)	27.75 (704.9)	-
20"	500	20.87 (530.1)	22.87 (580.9)	23.88 (606.6)	25.75 (654.1)	25.50 (647.7)	26.88 (682.8)	27.50 (698.5)	29.75 (755.7)	-
24"	600	24.87 (631.7)	26.87 (682.5)	28.25 (717.6)	30.50 (774.7)	30.25 (768.4)	31.13 (790.7)	33.00 (838.2)	35.50 (901.7)	-

Notes:

1. The dimensions for Class 300, Class 400, & Class 600 gaskets in NPS 1/2" - 3" sizes are the same and are designated as dual Class 300/400/600 in these sizes and shall be marked accordingly.
2. The dimensions for Class 900 & 1500 gaskets in NPS 1/2"- 2 1/2" are the same and are designated as dual Class 900/1500 in these sizes and shall be marked accordingly.
3. Where there are no sizes listed for Class 400 flanges in NPS 1/2 through NPS 3 1/2 (use Class 600); Class 900 flanges in NPS 1/2 through NPS 2 1/2 (use Class 1500).
4. There are no flanges in NPS 3 1/2 Class 900 and Class 1500; or Class 2500 flanges in NPS 3 1/2 or NPS 14 and larger.
5. Adapted from B16.20.

Gasket Dimensions - RTJ, Type R - Units in inches

Ring No.	Pressure Class Rating (psi)							Pitch Diameter of Ring	Width of Ring	Height of Ring		Gasket Weight, lbs.	
	ASME, BS & MSS					API (psi)				Oval	Octagonal	Oval	Octagonal
	150	300/600	900	1500	2500	2000/3000	5000						
	Nominal Pipe Size (in.)									P	A	B	H
R11	-	1/2	-	-	-	-	-	1.34	0.25	0.44	0.38	0.25	0.23
R12	-	-	1/2	1/2	-	-	-	1.56	0.31	0.56	0.50	0.48	0.44
R13	-	3/4	-	-	1/2	-	-	1.69	0.31	0.56	0.50	0.52	0.48
R14	-	-	3/4	3/4	-	-	-	1.75	0.31	0.56	0.50	0.53	0.49
R15	1	-	-	-	-	-	-	1.88	0.31	0.56	0.50	0.57	0.53
R16	-	1	1	1	3/4	1 / 1	1	2.00	0.31	0.56	0.50	0.61	0.56
R17	1-1/4	-	-	-	-	-	-	2.25	0.31	0.56	0.50	.69	0.72
R18	-	1-1/4	1-1/4	1-1/4	1	1-1/4 / 1-1/4	1-1/4	2.38	0.31	0.56	0.50	0.72	0.67
R19	1-1/2	-	-	-	-	-	-	2.56	0.31	0.56	0.50	0.78	0.72
R20*	-	1-1/2	1-1/2	1-1/2	-	1-1/2 / 1-1/2	1-1/2	2.69	0.31	0.56	0.50	0.82	0.76
R21	-	-	-	-	1-1/4	-	-	2.84	0.44	0.69	0.63	1.45	1.42
R22	2	-	-	-	-	-	-	3.25	0.31	0.56	0.50	0.99	0.91
R23*	-	2	-	-	1-1/2	2	-	3.25	0.44	0.69	0.63	1.66	1.62
R24*	-	-	2	2	-	- / 2	2	3.75	0.44	0.69	0.63	1.92	1.86
R25	2-1/2	-	-	-	-	-	-	4.00	0.31	0.56	0.50	1.22	1.12
R26*	-	2-1/2	-	-	2	2-1/2 / -	-	4.00	0.44	0.69	0.63	2.05	1.99
R27*	-	-	2-1/2	2-1/2	-	- / 2-1/2	2-1/2	4.25	0.44	0.69	0.63	2.31	2.12
R28	-	-	-	-	2-1/2	-	-	4.38	0.50	0.75	0.69	2.77	2.71
R29	3	-	-	-	-	-	-	4.50	0.31	0.56	0.50	1.37	1.27
R30†	-	3	-	-	-	-	-	4.63	0.44	0.69	0.63	2.37	2.31
R31*	-	3	3	-	-	3 / 3	-	4.88	0.44	0.69	0.63	2.49	2.43
R32	-	-	-	-	3	-	-	5.00	0.50	0.75	0.69	3.16	3.10
R33	3-1/2	-	-	-	-	-	-	5.19	0.31	0.56	0.50	1.58	1.46
R34	-	3-1/2	-	-	-	-	-	5.19	0.44	0.69	0.63	2.65	2.58
R35*	-	-	-	3	-	-	3	5.38	0.44	0.69	0.63	2.76	2.67
R36	4	-	-	-	-	-	-	5.88	0.31	0.56	0.50	1.79	1.63
R37*	-	4	4	-	-	4 / 4	3- 1/2	5.88	0.44	0.69	0.63	3.00	2.93
R38	-	-	-	-	4	-	-	6.19	0.63	0.88	0.81	5.64	3.56
R39*	-	-	-	4	-	-	4	6.38	0.44	0.69	0.63	3.26	3.17
R40	5	-	-	-	-	-	-	6.75	0.31	0.56	0.50	2.07	1.91
R41*	-	5	5	-	-	5 / 5	-	7.13	0.44	0.69	0.63	.66	3.55
R42	-	-	-	-	5	-	-	7.50	0.75	1.0	0.94	9.28	9.17
R43	6	-	-	-	-	-	-	7.63	0.31	0.56	0.50	2.33	2.15
R44*	-	-	-	5	-	-	5	7.63	0.44	0.69	0.63	3.90	3.81
R45*	-	6	6	-	-	6 / 6	-	8.31	0.44	0.69	0.63	4.25	4.15
R46*	-	-	-	6	-	-	6	8.31	0.50	0.75	0.69	5.27	5.14
R47*	-	-	-	-	6	-	-	9.0	0.75	1.0	0.94	11.16	11.00
R48	8	-	-	-	-	-	-	9.75	0.31	0.56	0.50	2.98	2.73
R49*	-	8	8	-	-	8 / 8	-	10.63	0.44	0.69	0.63	5.45	5.29
R50*	-	-	-	8	-	-	8	10.63	0.63	0.88	0.81	9.70	9.52
R51	-	-	-	-	8	-	-	11.0	0.88	1.13	1.06	17.75	18.01
R52	10	-	-	-	-	-	-	12.0	0.31	0.56	0.50	3.66	3.37
R53*	-	10	10	-	-	10 / 10	-	12.75	0.44	0.69	0.63	6.61	6.35
R54*	-	-	-	10	-	-	10	12.75	0.63	0.88	0.81	11.66	11.42
R55	-	-	-	-	10	-	-	13.5	1.13	1.44	1.38	35.78	15.52
R56	12	-	-	-	-	-	-	15.0	0.31	0.56	0.50	4.56	4.23
R57*	-	12	12	-	-	12 / 12	-	15.0	0.44	0.69	0.63	7.67	7.45
R58	-	-	-	12	-	-	-	15.0	0.88	1.13	1.06	-	-
R59	14	-	-	-	-	-	-	15.63	0.31	0.56	0.50	4.76	4.41
R60	-	-	-	-	12	-	-	16.00	1.25	1.56	1.50	50.93	51.81

Gasket Dimensions - RTJ, Type R - Units in inches - Cont'd

Ring No.	Pressure Class Rating (psi)							Pitch Diameter of Ring	Width of Ring	Height of Ring		Gasket Weight, lbs.	
	ASME, BS & MSS					API (psi)				Oval	Octagonal	Oval	Octagonal
	150	300/600	900	1500	2500	2000/3000	5000						
	Nominal Pipe Size (in.)									P	A	B	H
R61	-	14	-	-	-	14 / 14	-	16.50	0.44	0.69	0.63	8.44	8.16
R62	-	-	14	-	-	-	-	16.50	0.63	0.88	0.81	15.08	14.77
R63*	-	-	-	14	-	-	-	16.50	1.00	1.31	1.25	35.71	36.82
R64	16	-	-	-	-	-	-	17.88	0.31	0.56	0.50	5.45	5.07
R65*	-	16	-	-	-	16 / -	-	18.50	0.44	0.69	0.63	9.48	9.26
R66*	-	-	16	-	-	- / 16	-	18.50	0.63	0.87	0.81	16.91	16.53
R67	-	-	-	16	-	-	-	18.50	1.13	1.44	1.38	49.16	51.59
R68	18	-	-	-	-	-	-	20.38	0.31	0.56	0.50	6.22	5.73
R69*	-	18	-	-	-	18 / -	-	21.00	0.44	0.69	0.63	10.74	10.36
R70*	-	-	18	-	-	- / 18	-	21.00	0.75	1.00	0.94	26.01	25.37
R71	-	-	-	18	-	-	-	21.00	1.13	1.44	1.38	55.56	58.42
R72	20	-	-	-	-	-	-	22.00	0.31	0.56	0.50	6.70	6.17
R73*	-	20	-	-	-	20 / -	-	23.00	0.50	0.75	0.69	14.55	14.33
R74*	-	-	20	-	-	- / 20	-	23.00	0.75	1.00	0.94	28.55	28.22
R75	-	-	-	20	-	-	-	23.00	1.25	1.56	1.50	73.41	77.82
R76	24	-	-	-	-	-	-	26.50	0.31	0.56	0.50	8.08	7.50
R77	-	24	-	-	-	-	-	27.25	0.63	0.88	0.81	24.91	24.47
R78	-	-	24	-	-	-	-	27.25	1.00	1.31	1.25	59.75	60.85
R79	-	-	-	24	-	-	-	27.25	1.38	1.75	1.63	107.37	109.79
R80	-	-	-	-	-	-	-	24.25	0.31	-	0.50	-	3.11
R81	-	-	-	-	-	-	-	25.00	0.56	-	0.75	-	8.55
R82	-	-	-	-	-	-	-	2.25	0.44	-	0.63	-	0.51
R84*	-	-	-	-	-	-	1-1/2	2.50	0.44	-	0.63	-	0.55
R85*	-	-	-	-	-	-	2	3.13	0.50	-	0.69	-	0.97
R86*	-	-	-	-	-	-	2-1/2	3.56	0.63	-	0.81	-	1.46
R87*	-	-	-	-	-	-	3	3.94	0.63	-	0.81	-	1.59
R88*	-	-	-	-	-	-	4	4.88	0.75	-	0.94	-	2.73
R89*	-	-	-	-	-	-	3-1/2	4.50	0.75	-	0.94	-	2.54
R90*	-	-	-	-	-	-	5	6.13	0.88	-	1.06	-	4.54
R91*	-	-	-	-	-	-	10	10.25	1.25	-	1.50	-	15.06
R92	-	-	-	-	-	-	-	9.00	0.44	0.69	0.63	2.07	2.01
R93	-	-	-	-	-	-	-	29.50	0.75	-	0.94	-	16.34
R94	-	-	-	-	-	-	-	31.50	0.75	-	0.94	-	17.44
R95	-	-	-	-	-	-	-	33.75	0.75	-	0.94	-	18.70
R96	-	-	-	-	-	-	-	36.00	0.88	-	1.06	-	26.65
R97	-	-	-	-	-	-	-	38.00	0.88	-	1.06	-	28.13
R98	-	-	-	-	-	-	-	40.25	0.88	-	1.06	-	29.78
R99*	-	-	-	-	-	8 / 8	-	9.25	0.44	-	0.63	-	2.07
R100	-	-	-	-	-	-	-	29.50	1.13	-	1.38	-	-
R101	-	-	-	-	-	-	-	31.50	1.25	-	1.50	-	-
R102	-	-	-	-	-	-	-	33.75	1.25	-	1.50	-	-
R103	-	-	-	-	-	-	-	36.00	1.25	-	1.50	-	-
R104	-	-	-	-	-	-	-	38.00	1.38	-	1.63	-	-
R105	-	-	-	-	-	-	-	40.25	1.38	-	1.63	-	-

* Denotes ring number specified in API 6A

Nominal Pipe Sized marked ** applies to class rating 2000 only

Nominal Pipe Sizes in brackets apply to class rating 3000 only

± Ring no. R30 is suitable for lapping flanges only

Adapted from ASME B16.20

Gasket Dimensions - RTJ, Type R - Units in millimeters

Ring No.	Pressure Class Rating (psi)							Pitch Diameter of Ring	Width of Ring	Height of Ring		Gasket Weight, kg	
	ASME, BS & MSS					API (psi)				Oval	Octagonal	Oval	Octagonal
	150	300/600	900	1500	2500	2000/3000	5000						
	Nominal Pipe Size (in.)									P	A	B	H
R11	-	1/2	-	-	-	-	-	34.14	6.35	11.20	9.70	0.11	0.10
R12	-	-	1/2	1/2	-	-	-	39.70	7.95	14.20	12.70	0.21	0.20
R13	-	3/4	-	-	1/2	-	-	42.88	7.95	14.20	12.70	0.23	0.21
R14	-	-	3/4	3/4	-	-	-	44.45	7.95	14.20	12.70	0.24	0.22
R15	1	-	-	-	-	-	-	47.63	7.95	14.20	12.70	0.26	0.24
R16	-	1	1	1	3/4	1 / 1	1	50.80	7.95	14.20	12.70	0.28	0.26
R17	1-1/4	-	-	-	-	-	-	57.15	7.95	14.20	12.70	0.31	0.33
R18	-	1-1/4	1-1/4	1-1/4	1	1-1/4 / 1-1/4	1-1/4	60.33	7.95	14.20	12.70	0.33	0.30
R19	1-1/2	-	-	-	-	-	-	65.10	7.95	14.20	12.70	0.35	0.33
R20*	-	1-1/2	1-1/2	1-1/2	-	1-1/2 / 1-1/2	1-1/2	68.28	7.95	14.20	12.70	0.37	0.34
R21	-	-	-	-	1-1/4	-	-	72.24	11.13	17.50	16.00	0.66	0.64
R22	2	-	-	-	-	-	-	82.55	7.95	14.20	12.70	0.45	0.42
R23*	-	2	-	-	1-1/2	2 / -	-	82.55	11.13	17.50	16.00	0.76	0.73
R24*	-	-	2	2	-	- / 2	2	95.25	11.13	17.50	16.00	0.87	0.85
R25	2-1/2	-	-	-	-	-	-	101.60	7.95	14.20	12.70	0.55	0.51
R26*	-	2-1/2	-	-	2	2-1/2 / -	-	101.60	11.13	17.50	16.00	0.93	0.90
R27*	-	-	2-1/2	2-1/2	-	- / 2-1/2	2-1/2	107.95	11.13	17.50	16.00	1.05	0.96
R28	-	-	-	-	-	2-1/2	-	111.13	12.70	19.10	17.50	1.26	1.23
R29	3	-	-	-	-	-	-	114.30	7.95	14.20	12.70	0.62	0.58
R30†	-	3	-	-	-	-	-	117.48	11.13	17.50	16.00	1.08	1.05
R31*	-	3	3	-	-	3 / 3	-	123.83	11.13	17.50	16.00	1.13	1.10
R32	-	-	-	-	3	-	-	127.00	12.70	19.10	17.50	1.43	1.41
R33	3-1/2	-	-	-	-	-	-	131.78	7.95	14.20	12.70	0.71	0.66
R34	-	3-1/2	-	-	-	-	-	131.78	11.13	17.50	16.00	1.20	1.17
R35*	-	-	-	3	-	-	3	136.53	11.13	17.50	16.00	1.25	1.21
R36	4	-	-	-	-	-	-	149.23	7.95	14.20	12.70	0.81	0.74
R37*	-	4	4	-	-	4 / 4	3-1/2	149.23	11.13	17.50	16.00	1.36	1.33
R38	-	-	-	-	4	-	-	157.18	15.88	22.40	20.60	2.56	2.52
R39*	-	-	-	4	-	-	4	161.93	11.13	17.50	16.00	1.48	1.44
R40	5	-	-	-	-	-	-	171.45	7.95	14.20	12.70	0.94	0.87
R41*	-	5	5	-	-	5 / 5	-	180.98	11.13	17.50	16.00	1.66	1.61
R42	-	-	-	-	-	-	-	190.50	19.05	25.40	23.90	4.21	4.16
R43	6	-	-	-	-	-	-	193.68	7.95	14.20	12.70	1.06	0.98
R44*	-	-	-	5	-	-	5	193.68	11.13	17.50	16.00	1.77	1.73
R45*	-	6	6	-	-	6 / 6	-	211.15	11.13	17.50	16.00	1.93	1.88
R46*	-	-	-	6	-	-	6	211.15	12.70	19.10	17.50	2.39	2.33
R47*	-	-	-	-	6	-	-	228.60	19.05	25.40	23.90	5.06	4.99
R48	8	-	-	-	-	-	-	247.65	7.95	14.20	12.70	1.35	1.24
R49*	-	8	8	-	-	8 / 8	-	269.88	11.13	17.50	16.00	2.47	2.40
R50*	-	-	-	8	-	-	8	269.88	15.88	22.40	20.60	4.40	4.32
R51	-	-	-	-	8	-	-	279.40	22.23	28.70	26.90	8.05	8.17
R52	10	-	-	-	-	-	-	304.80	7.95	14.20	12.70	1.66	1.53
R53*	-	10	10	-	-	10 / 10	-	323.85	11.13	17.50	16.00	3.00	2.88
R54*	-	-	-	10	-	-	10	323.85	15.88	22.40	20.60	5.29	5.18
R55	-	-	-	-	10	-	-	342.90	28.58	36.60	35.10	16.23	17.04
R56	12	-	-	-	-	-	-	381.00	7.95	14.20	12.70	2.07	1.92
R57*	-	12	12	-	-	12 / 12	-	381.00	11.13	17.50	16.00	3.48	3.38
R58	-	-	-	12	-	-	-	381.00	22.23	28.70	26.90	-	-

Gasket Dimensions - RTJ, Type R - Units in millimeters - Cont'd

Ring No.	Pressure Class Rating (psi)							Pitch Diameter of Ring	Width of Ring	Height of Ring		Gasket Weight, kg	
	ASME, BS & MSS					API (psi)				Oval	Octagonal	Oval	Octagonal
	150	300/600	900	1500	2500	2000/3000	5000						
	Nominal Pipe Size (in.)									P	A	B	H
R59	14	-	-	-	-	-	-	396.88	7.95	14.20	12.70	2.16	2.00
R60	-	-	-	-	12	-	-	406.40	31.75	39.60	38.10	23.10	23.50
R61	-	14	-	-	-	14 / 14	-	419.10	11.13	17.50	16.00	3.83	3.70
R62	-	-	14	-	-	-	-	419.10	15.88	22.40	20.60	6.84	6.70
R63*	-	-	-	14	-	-	-	419.10	25.4	33.30	31.80	16.20	16.70
R64	16	-	-	-	-	-	-	454.03	7.95	14.20	12.70	2.47	2.30
R65*	-	16	-	-	-	16 / -	-	469.90	11.13	17.50	16.00	4.30	4.20
R66*	-	-	16	-	-	- / 16	-	469.90	15.88	22.40	20.60	7.67	7.50
R67	-	-	-	16	-	-	-	469.90	28.58	36.60	35.10	22.30	23.40
R68	18	-	-	-	-	-	-	517.53	7.95	14.20	12.70	2.82	2.60
R69*	-	18	-	-	-	-	-	533.40	11.13	17.50	16.00	4.87	4.70
R70*	-	-	18	-	-	18 / -	-	533.40	19.05	25.40	23.90	11.80	11.60
R71	-	-	-	18	-	-	-	533.40	28.58	36.60	35.10	25.20	26.50
R72	20	-	-	-	-	-	-	558.80	7.95	14.20	12.70	3.04	2.80
R73*	-	20	-	-	-	20 / -	-	584.20	12.70	19.10	17.50	6.60	6.50
R74*	-	-	20	-	-	- / 20	-	584.20	19.05	25.40	23.90	12.95	12.80
R75	-	-	-	20	-	-	-	584.20	31.75	39.60	38.10	33.30	35.30
R76	24	-	-	-	-	-	-	673.10	7.95	14.20	12.70	3.66	3.40
R77	-	24	-	-	-	-	-	692.15	15.88	22.40	20.60	11.30	11.10
R78	-	-	24	-	-	-	-	692.15	25.40	33.30	31.80	27.10	27.60
R79	-	-	-	24	-	-	-	692.15	34.93	44.50	41.40	48.70	49.80
R80	-	-	-	-	-	-	-	615.95	7.95	-	12.70	-	1.41
R81	-	-	-	-	-	-	-	635.00	14.30	-	19.10	-	3.88
R82	-	-	-	-	-	-	1	57.15	11.13	-	16.00	-	0.23
R84*	-	-	-	-	-	-	1-1/2	63.50	11.13	-	16.00	-	0.25
R85*	-	-	-	-	-	-	2	79.38	12.70	-	17.50	-	0.44
R86*	-	-	-	-	-	-	2-1/2	90.50	15.88	-	20.60	-	0.66
R87*	-	-	-	-	-	-	3	100.03	15.88	-	20.60	-	0.72
R88*	-	-	-	-	-	-	4	122.83	19.05	-	23.90	-	1.24
R89*	-	-	-	-	-	-	3-1/2	114.30	19.05	-	23.90	-	1.15
R90*	-	-	-	-	-	-	5	155.58	22.23	-	26.90	-	2.06
R91*	-	-	-	-	-	-	10	260.35	31.75	-	38.10	-	6.83
R92	-	-	-	-	-	-	-	228.60	11.13	17.50	16.00	0.94	0.91
R93	-	-	-	-	-	-	-	749.30	19.05	-	23.90	-	7.41
R94	-	-	-	-	-	-	-	800.10	19.05	-	23.90	-	7.91
R95	-	-	-	-	-	-	-	857.25	19.05	-	23.90	-	8.48
R96	-	-	-	-	-	-	-	914.40	22.23	-	26.90	-	12.09
R97	-	-	-	-	-	-	-	965.20	22.23	-	26.90	-	12.76
R98	-	-	-	-	-	-	-	1022.35	22.23	-	26.90	-	13.51
R99*	-	-	-	-	-	8 / 8	-	234.95	11.13	-	16.00	-	0.94
R100	-	-	-	-	-	-	-	749.30	28.58	-	35.10	-	-
R101	-	-	-	-	-	-	-	800.10	31.75	-	38.10	-	-
R102	-	-	-	-	-	-	-	857.25	31.75	-	38.10	-	-
R103	-	-	-	-	-	-	-	914.40	31.75	-	38.10	-	-
R104	-	-	-	-	-	-	-	965.20	34.93	-	41.40	-	-
R105	-	-	-	-	-	-	-	1022.35	34.93	-	41.40	-	-

Gasket Dimensions - RTJ, Type RX - Units in inches

Ring No.	Pressure Class Rating (psi)			Outside Diameter of Ring	Width of Ring	Height of Ring	Gasket Weight, lbs
	2000	3000	5000				
	Nominal Pipe Size (in.)						
RX20	1-1/2	1-1/2	1-1/2	3.00	0.34	0.75	0.53
RX23	2	-	-	3.67	0.47	1.00	1.15
RX24	-	2	2	4.17	0.47	1.00	1.32
RX251	-	-	3 -1/8	4.31	0.34	0.75	1.41
RX26	2-1/2	-	-	4.41	0.47	1.00	1.50
RX27	-	2-1/2	2-1/2	4.66	0.47	1.00	1.72
RX31	3	3	-	5.30	0.47	1.00	1.92
RX35	-	-	3	5.80	0.47	1.00	2.09
RX37	4	4	-	6.30	0.47	1.00	2.27
RX39	-	-	4	6.80	0.47	1.00	2.54
RX41	5	5	-	7.55	0.47	1.00	2.71
RX44	-	-	5	8.05	0.47	1.00	2.95
RX45	6	6	-	8.73	0.47	1.00	3.66
RX46	-	-	6	8.75	0.53	1.13	8.55
RX47	-	-	8	9.66	0.78	1.63	3.79
RX49	8	8	-	11.05	0.47	1.00	5.36
RX50	-	-	8	11.16	0.66	1.25	4.56
RX53	10	10	-	13.17	0.47	1.00	14.22
RX54	-	-	10	13.28	0.66	1.25	11.82
RX57	12	12	-	15.42	0.47	1.00	58.20
RX63	-	-	14	17.39	1.06	2.00	14.62
RX65	16	-	-	18.92	0.47	1.00	20.70
RX66	-	16	-	19.03	0.66	1.25	16.58
RX69	18	-	-	21.42	0.47	1.00	44.40
RX70	-	18	-	21.66	0.78	1.63	25.64
RX73	20	-	-	23.47	0.53	1.25	48.72
RX74	-	20	-	23.66	0.78	1.63	1.74
RX82	-	-	-	2.67	0.47	1.00	1.94
RX84	-	-	-	2.92	0.47	1.00	1.94
RX85	-	-	-	3.55	0.53	1.00	3.95
RX86	-	-	-	4.08	0.59	1.13	4.37
RX87	-	-	-	4.45	0.59	1.13	7.10
RX88	-	-	-	5.48	0.69	1.25	6.57
RX89	-	-	-	5.11	0.72	1.25	15.04
RX90	-	-	-	6.88	0.78	1.75	37.70
RX91	-	-	-	11.30	1.19	1.78	7.30
*RX99	8	8	-	9.67	0.47	1.00	-
RX2011	-	-	1 -3/8	2.03	0.23	0.45	-
*RX205†	-	-	1-13/16	2.45	0.22	0.44	-
*RX210†	-	-	2-9/16	3.84	0.38	0.75	-
*RX215	-	-	4-1/16	5.55	0.47	1.00	-

* API allows more liberal tolerances on RX 201-215

± Denotes API RTJ gaskets for segmented flanges for dual completions to API Standard 6A

Adapted from ASME B16.20

Gasket Dimensions - RTJ, Type RX - Units in millimeters

Ring No.	Pressure Class Rating (psi)			Outside Diameter of Ring	Width of Ring	Height of Ring	Gasket Weight, kg
	2000	3000	5000				
	Nominal Pipe Size (in.)			OD	A	H	
RX20	1-1/2	1-1/2	1-1/2	76.20	8.74	19.05	0.24
RX23	2	-	-	93.27	11.91	25.40	0.52
RX24	-	2	2	105.97	11.91	25.40	0.60
RX25†	-	-	3-1/8	109.55	8.74	19.05	0.64
RX26	2-1/2	-	-	111.91	11.91	25.40	0.68
RX27	-	2-1/2	2-1/2	118.26	11.91	25.40	0.78
RX31	3	3	-	134.54	11.91	25.40	0.87
RX35	-	-	3	147.24	11.91	25.40	0.95
RX37	4	4	-	159.94	11.91	25.40	1.03
RX39	-	-	4	172.64	11.91	25.40	1.15
RX41	5	5	-	191.69	11.91	25.40	1.23
RX44	-	-	5	204.39	11.91	25.40	1.34
RX45	6	-	6	221.84	11.91	25.40	1.66
RX46	-	-	6	222.25	13.49	28.58	3.88
RX47	-	-	8	245.26	19.84	41.28	1.72
RX49	8	8	-	280.59	11.91	25.40	2.43
RX50	-	-	8	283.36	16.66	31.75	2.07
RX53	10	10	-	334.57	11.91	25.40	6.45
RX54	-	-	10	337.34	16.66	31.75	5.36
RX57	12	12	-	391.72	11.91	25.40	26.40
RX63	-	-	14	441.73	27.00	50.80	6.63
RX65	16	-	-	480.62	11.91	25.40	9.39
RX66	-	16	-	483.39	16.66	31.75	7.52
RX69	18	-	-	544.12	11.91	25.40	20.14
RX70	-	18	-	550.06	19.84	41.28	11.63
RX73	20	-	-	596.11	13.49	31.75	22.10
RX74	-	20	-	600.86	19.84	41.28	0.79
RX82	-	-	-	67.87	11.91	25.40	0.88
RX84	-	-	-	74.22	11.91	25.40	0.88
RX85	-	-	-	90.09	13.49	25.40	1.79
RX86	-	-	-	103.58	15.09	28.58	1.98
RX87	-	-	-	113.11	15.09	28.58	3.22
RX88	-	-	-	139.29	17.48	31.75	2.98
RX89	-	-	-	129.77	18.26	31.75	6.82
RX90	-	-	-	174.63	19.84	44.45	17.10
RX91	-	-	-	286.94	30.18	45.24	3.31
*RX99	8	8	-	245.67	11.91	25.40	-
RX201†	-	-	1-3/8	51.46	5.74	11.30	-
*RX205†	-	-	1-13/16	62.31	5.56	11.10	-
*RX210†	-	-	2-9/16	97.64	9.53	19.05	-
*RX215	-	-	4-1/16	140.89	11.91	25.40	-

Gasket Dimensions - RTJ, Type BX - Units in inches

Ring No.	Pressure Class Rating (psi)				Outside Diameter	Height of Ring	Width of Ring	Hole Size	Gasket Weight, lbs
	5000	10000	15000	20000					
	Nominal Pipe Size (in.)								
BX150	-	1-11/16	1-11/16	-	2.84	0.37	0.37	0.06	0.66
BX151	-	1-13/16	1-13/16	1-13/16	3.01	0.38	0.38	0.06	0.75
BX152	-	2-1/16	2-1/16	2-1/16	3.33	0.40	0.40	0.06	0.95
BX153	-	2-9/16	2-9/16	2-9/16	3.97	0.45	0.45	0.06	1.39
BX154	-	3-1/16	3-1/16	3-1/16	4.60	0.49	0.49	0.06	1.94
BX155	-	4-1/16	4-1/16	4-1/16	5.83	0.56	0.56	0.06	2.69
BX156	-	7-1/16	7-1/16	7-1/16	9.37	0.73	0.73	0.12	9.13
BX157	-	9	9	9	11.59	0.83	0.83	0.12	14.44
BX158	-	11	11	11	13.86	0.91	0.91	0.12	21.16
BX159	-	13-5/8	13-5/8	13-5/8	16.80	1.01	1.01	0.12	31.77
BX160	13-5/8	-	-	-	15.85	0.94	0.54	0.12	14.88
BX161	16-3/4	-	-	-	19.35	1.11	0.64	0.12	-
BX162	16-3/4	16-3/4	16-3/4	-	18.72	0.56	0.56	0.06	-
BX163	18-3/4	-	-	-	21.90	1.19	0.68	0.12	-
BX164	-	18-3/4	18-3/4	-	22.46	1.19	0.97	0.12	-
BX165	21-1/4	-	-	-	24.60	1.26	0.73	0.12	-
BX166	-	21-1/4	-	-	25.20	1.26	1.03	0.12	-
BX167*	-	-	-	-	29.90	1.41	0.52	0.06	-
BX168†	-	-	-	-	30.13	1.41	0.63	0.06	-
BX169**	-	5-1/8	-	-	6.83	0.62	0.51	0.06	-
BX170	-	6-5/8	6-5/8	-	8.58	0.56	0.56	0.06	-
BX171	-	8-9/16	8-9/16	-	10.53	1.56	0.56	0.06	-
BX172	-	11-5/32	11-5/32	-	13.11	0.56	0.56	0.06	-
BX303‡	-	-	-	-	33.57	1.49	0.67	0.06	-

Gasket Dimensions - RTJ, Type BX - Units in millimeters

Ring No.	Pressure Class Rating (psi)				Outside Diameter	Height of Ring	Width of Ring	Hole Size	Gasket Weight, kg
	5000	10000	15000	20000					
	Nominal Pipe Size (in.)								
BX150	-	1-11/16	1-11/16	-	72.19	9.30	9.30	1.50	0.30
BX151	-	1-13/16	1-13/16	1-13/16	76.40	9.63	9.63	1.50	0.34
BX152	-	2-1/16	2-1/16	2-1/16	84.68	10.24	10.24	1.50	0.43
BX153	-	2-9/16	2-9/16	2-9/16	100.94	11.38	11.38	1.50	0.63
BX154	-	3-1/16	3-1/16	3-1/16	116.84	12.40	12.40	1.50	0.88
BX155	-	4-1/16	4-1/16	4-1/16	147.96	14.22	14.22	1.50	1.22
BX156	-	7-1/16	7-1/16	7-1/16	237.92	18.62	18.62	3.18	4.14
BX157	-	9	9	9	294.46	20.98	20.98	3.18	6.55
BX158	-	11	11	11	352.04	23.14	23.14	3.18	9.60
BX159	-	13-5/8	13-5/8	13-5/8	426.72	25.70	25.70	3.18	14.41
BX160	13-5/8	-	-	-	402.59	23.83	13.74	3.18	6.75
BX161	16-3/4	-	-	-	491.41	28.07	16.21	3.18	-
BX162	16-3/4	16-3/4	16-3/4	-	475.49	14.22	14.22	1.59	-
BX163	18-3/4	-	-	-	556.16	30.10	17.37	3.18	-
BX164	-	18-3/4	18-3/4	-	570.56	30.10	24.59	3.18	-
BX165	21-1/4	-	-	-	624.71	32.03	18.49	3.18	-
BX166	-	21-1/4	-	-	640.03	32.03	26.14	3.18	-
BX167*	-	-	-	-	759.36	35.86	13.11	1.59	-
BX168†	-	-	-	-	765.25	35.86	16.05	1.59	-
BX169**	-	5-1/8	-	-	173.51	15.85	12.93	1.59	-
BX170	-	6-5/8	6-5/8	-	218.03	14.22	14.22	1.59	-
BX171	-	8-9/16	8-9/16	-	267.44	14.22	14.22	1.59	-
BX172	-	11-5/32	11-5/32	-	333.07	14.22	14.22	1.59	-
BX303‡	-	-	-	-	852.75	37.95	16.97	1.59	-

*BX167 is suitable for 23-3/4" Nominal Pipe Size 2,000 psi rating

‡BX168 is suitable for 26-3/4" Nominal Pipe Size 3,000 psi rating

** BX169 is suitable for 5-3/4" Nominal Pipe Size 10,000 psi rating

‡‡BX303 is suitable for 30" Nominal Pipe Size 2,000 and 3,000 psi rating

Custom Capabilities

Nearly every facility requires some custom fabricated gaskets that fall outside of industry-standard dimensions. Durlon® prides itself in offering high-quality fabricated sealing components with high-precision and fast turnaround capabilities. At our manufacturing and fabricating facilities, we produce sealing products from sheet materials using 3 primary methods: gasket cutting, welding, and lathe cutting.

Cutting in general is considered to be the most common type of gasket fabrication method. Many fabricators use stamping machines of various speeds and accuracies to cut gaskets. This method requires tool and die builds, which can add to the unit cost and delivery time of the finished parts. This method is not ideal when true custom-shaped gaskets are required.

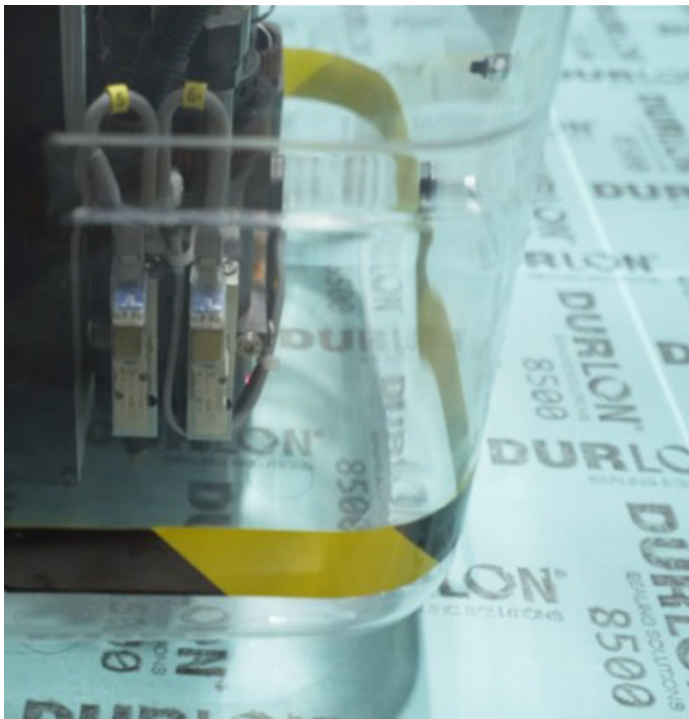

FLASH CUTTER

We use modern digital flatbed cutting machines that can cut gaskets with precision, accuracy, and less start-up time, resulting in improved quality of the finished parts. Our machines work with various styles of sheet gasket materials; single, multilayered, and in thicknesses up to 8mm (5/16”).

With our primary CNC controlled cutting table, we can quickly, and precisely cut almost any custom shape with no minimum order requirements. Our equipment eliminates the need to have dies made, which is costly and comes with long lead times. We package all cut gaskets with lot traceability identification tags in compliance with our ISO Quality System.

PTFE WELDING

Some applications used in designs for chemical reactors, food & beverage vessels, and heat exchangers, require PTFE gaskets larger than 1,524mm (60”) in diameter. Many fabricators simply use a traditional dovetail design, joining several segments together to form the finished large gasket. Sometimes these dovetails are wrapped in additional material and may be covered in special form-in-place liquid sealants, in order to seal the leak paths created from this design. This approach may lead to leaks and can make the gasket very hard to install.

By using segments cut from our digital flatbed cutting machine, we are able to solve dovetail design problems. We can bond segments together, creating a superior performing gasket with our proprietary welding procedure, and equipment designed by our in-house mechanical engineering experts. Our finished Ring Type or Full Face gaskets can be made with cross-sections up to 229mm (9”) wide, giving our customers the reassurance that their large diameter sealing requirements will perform as expected.

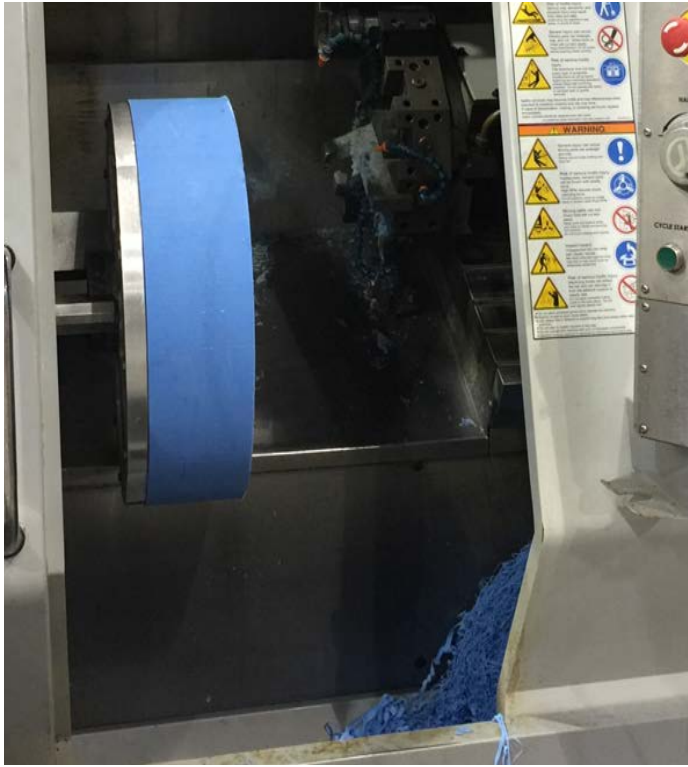

LATHE CUTTING

The lathe cutting process produces an extremely precise and accurately cut, finished gasket because it follows the same stringent quality control parameters as our large sheet manufacturing process. This process is efficient and cost effective when producing high volume ring gaskets and highly recommended for smaller PTFE billets.

Our lathe-cut PTFE gaskets are produced using only the best quality billets of Durlon® 9000, 9000N, 9200, and 9400 – some of the most highly recommended PTFE gasket material approved for use with a number of important industrial chemicals.



RCA® GASKETS

The Durlon® RCA® (Reduced Contact Area) sealing system combined with Durlon® PTFE styles, can replace standard Full Face gaskets in FRP, PVC, and other non-metallic and metallic pipe flanges, where a low stress gasket is required. The RCA® configuration reduces the

total gasket contact area, resulting in a lower seating stress at a given torque level, while preventing flange rotation.

The RCA® configuration can be cut from standard sheets resulting in a cost savings, versus other low stress gaskets.

Available Materials: Durlon® PTFE and Compressed Non-Asbestos styles.

CUSTOM FABRICATED METALLIC GASKETS

We custom manufacture spiral wound and kammprofile gaskets to customer dimensional and material requirements. Both gasket styles can be manufactured with common pass bar styles, typically used in heat exchangers up to 2,642mm (104”) in diameter. Using sophisticated semi-automatic digital equipment, we can ensure that dimensional stability and assembly precision are met on every gasket produced. Combined with full internal traceability on raw materials, we provide custom fabricated metallic gaskets that can be depended on for the entire lifespan of the installation.

CUSTOM METALLURGY

Due to increasing demand in high performance metallurgy requests for both critical and chemical applications, we stock numerous alloys for both standard and custom gasket requirements. Our metal inventory includes: 304SS, 316L, 317SS, 321SS, 347SS, Monel 400, Duplex 2205, Super Duplex 2507, Alloy 20, Hastelloy C276, Inconel 600/750/825, Titanium, and Zirconium (Zr702). Don't see it on the list? Give us call! We may have it or can get it for you.

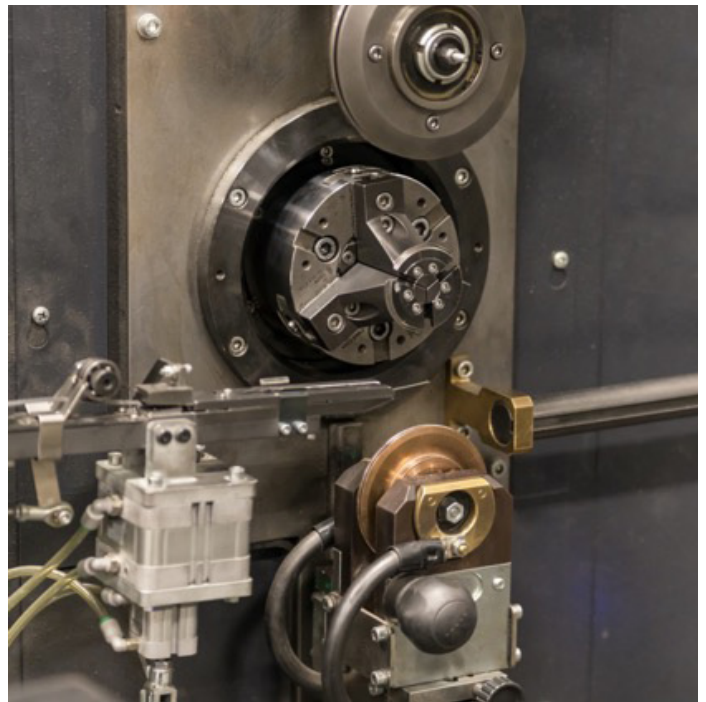

SWG WINDING MACHINE

- Ensures repeatability and consistent quality
- Quick turnaround on Style D, DR, and DRI gaskets
- Custom thicknesses available for special OEM equipment
- Sizes from 1/2” ID to 157” OD

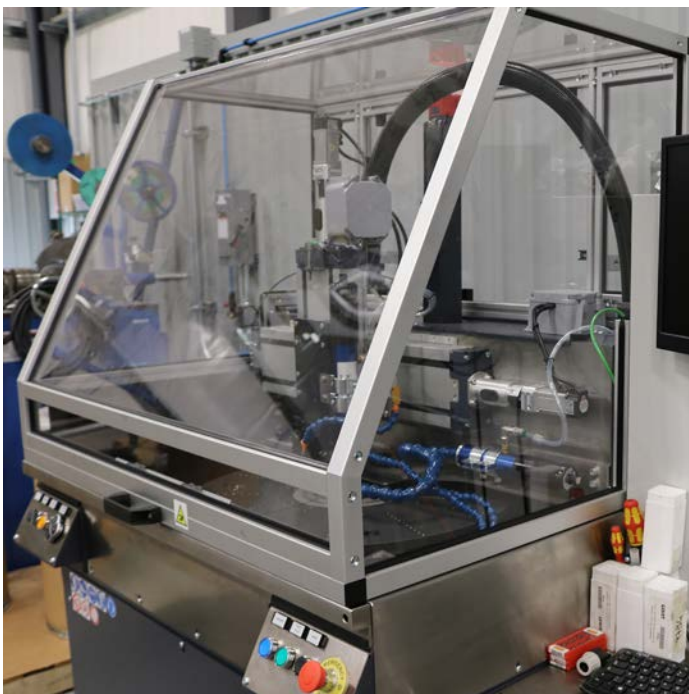

KAMMPROFILE/DURTEC GASKETS

- Size range 1/2" – 157"
- Parallel and convex cores
- Floating and integral CR's
- SWG Centering Rings
- SWG Inner Rings

This new technology allows us to offer high precision products with quick turn around times, on both standard and custom gaskets in metallurgies that can range from 304SS to Zirconium.



HYDRAULIC BENDER

Hydraulic bending allows us the ability to bend rings for both spiral wound components and kammprofile gaskets utilizing the flat bar strip from either slit coils or strips cut from sheets on our water jet table. This allows us to be more cost effective when manufacturing large OD gaskets because there is no center drop from the material, which can increase the gasket's cost. We have the ability to bend gasket OD's from 8"-167" with 1/4" through 2" cross sections.



WATER JET CUTTING

State of art water jet cutting table with high intensity pump and 5 axis cutting head, allows 3D cutting for up to 6'6" x 10' sheets of metal, CNA, and PTFE. With this new addition to our manufacturing facility, we can cut all metal gasket components from SWG's to Kammpfiles, with cutting speeds of 400 IPM speed range and +/- 0.005" accuracy.



LASER MARKING

We utilize a Class 1 fiber laser to mark all of our metal gasket components for easy identification and traceability. Not only does it mark the size and class of the gasket, but the heat #, PO# and even QR Code can be added if required.



LAB CAPABILITIES

All our gasket testing is done in-house on both qualified raw material and finished gasket products. We perform various ASTM tests for gasket properties; tensile, creep, leakage, and compressibility/recovery. We have ovens for conditioning samples and performing our own oxidation testing on graphite and other high-temperature materials. Our Amtec machine allows us to perform all standard required gasket performance testing, along with other tests that require high levels of accuracy. We test gasket factors (EN 13555), ultra-low emissions leakage testing with the use of a helium mass spectrometer, and competitor material testing. We have PMI (Positive Material Identification), and hardness testing equipment for verification of all our metallurgy that is brought into the plant, and before being used for production.



AUTODESK
AUTOCAD LT®

AUTO CAD & DESIGN

Our AutoDesk CAD design programs (AutoCAD and Inventor Professional) allow us to create both 2D and 3D drawings of gaskets and components, as well as utilize FEA analysis if dealing with tricky or problematic sealing solutions.

Our design team is available to help with the conversion of older paper drawings, into digital files that can then be programmed into our Flash cutting machines or water jet table.

Need something drawn up or converted into a digital file? No problem. Just send us a sketch, or the original drawing!



SKIVING

Durlon® PTFE skived materials give gasket cutters great value due to higher yields and optimal performance. With our proprietary manufacturing method, we are able to hold a tight thickness tolerance across a 60" sheet. Additionally, we are able to offer sheet lengths in 60" increments. Longer sheet lengths provide better yields and many gasket cutters prefer to take full rolls of material for continuous feed cutting operations.

Curious about improving your gasket cutting yields? Give us a call.



igasket+ App Now Available

igasket+ is a simple, intuitive interface used by engineers and service technicians in the field. Based on a variety of user inputs, a list of compatible Durlon gaskets is generated using temperature, pressure, fluid and flange type.

Additional functionality: "Torque Value Calculator" and "Unit of Measure Converter".



www.igasketplus.com



DURLON[®]

SEALING SOLUTIONS



Durlon[®] is a registered trademark of Triangle Fluid Controls Ltd.[®] and Gasket Resources Inc.[®]

durlon.com • trianglefluid.com • gasketresources.com
durabla.ca • durlon.cn • durablaasia.com.sg